

www.larsonjuhl.co.uk

sales order line and enquiry 01234 852777
uksales@larsonjuhl.com

international sales 00 44 1234 846307
export@larsonjuhl.com

Larson-Juhl UK
Unit 5 Bedford Link Logistics Park
Bell Farm Way
Kempston, MK43 9SS



999000960/08/21

LARSON · JUHL®

VOLUME 15



LARSON · JUHL®

Catalogue
Volume 15





Welcome to

LARSON·JUHL®

Welcome to Larson-Juhl's 15th product catalogue which showcases our extensive range of mouldings. We are a one stop shop for all of your framing requirements; we have quality products to accommodate all styles and suit all price points.

Mouldings

Inside, you will find more than 2,000 mouldings from Larson-Juhl's core range.

The Larson-Juhl Signature Collection offers superb craftsmanship and quality with an abundance of styles to meet the most demanding framing requirements.

Designed to meet the needs of a wider market, our ever-popular Larson-Juhl range of Essential mouldings continues to be a huge hit with customers, with products to meet every framing need.

The Designer mouldings range is distributed exclusively by Larson-Juhl in the UK and offers a versatile collection of aluminium mouldings in a variety of colours and finishes.

Whether framing an old master or a piece of contemporary art, there is a moulding to suit every occasion.

The Frame Collection

Our consistently popular Frame Collection offers an extensive choice, including Decorative, Swept, Oval and Circle, Loft, and Overmantle frames. So whatever your customer is looking for, there is a frame to suit their needs.

Mountboard

Our wide range of UK manufactured mountboard comes in over 300 colours and styles, many of which are FSC certified.

Contact us if you want to see our mountboard colour chart which shows the actual cover paper used in our range.

Glass and Sundries

Please visit our website to view our extensive selection including our glass range: Clarity by Larson-Juhl.

Larson-Juhl Quality

Larson-Juhl leads the market in moulding development. Our innovative and dynamic approach is matched only by our commitment to craftsmanship, tradition and customer service.

To ensure we continue to offer the best possible service to our customers we use only the highest quality suppliers who meet our stringent demands of product quality and supply capabilities.

We have strict control procedures in place to ensure our stocks remain at a consistently high quality. All incoming mouldings are checked against master mouldings for correct specification, finish and quality.

Showroom

If you are looking for inspiration on how to freshen up your chevron displays, or just want to have a look at our latest products, you are welcome to visit our showroom in Bedford.

Relax in the comfort of our showroom and let your Area Sales Manager or our Customer Service Team show you our full moulding range. Designed with a 360 panoramic viewpoint from the centre of the room, and comfortable seating. Our versatile flexi boards allow you to remove moulding from the walls and create your own selections.

Contact your Area Sales Manager or call the Customer Service Team to arrange a visit.

Website

Our website is the best place to order and view all our mouldings – it showcases all our products and also provides live stock updates.

How to locate Mouldings

Larson-Juhl offers over 2,000 different mouldings in a wide range of styles and finishes to suit every framing requirement. Locating mouldings in this catalogue could not be simpler. Each type of moulding finish is listed in the contents section and all of the mouldings are indexed numerically at the back.

Next to each moulding, you will find the code, colour and a symbol to indicate the finish.

We have included a sustainability section so you can locate all FSC and PEFC certified mouldings in one section. The Larson-Juhl Signature Collection is featured together by range and our Essential mouldings are grouped by colour or type.

Although the catalogue represents our full range at the time of going to press, we are continually adding new and exciting mouldings to the range. Your Area Sales Manager or our Customer Service Team will be happy to update you with the latest additions or alternatively please visit our website.

If colour is critical we would recommend that you request samples before you order.

Please note: Dimensions are included for width, overall depth, rebate depth and rebate width.

The line measurements are precise; however, depth may look distorted against the image due to the angle of photography and as the measurement to the deepest part of the moulding is not always at the top of the image.

Free Sample Service

We are pleased to supply you with a free reference sample service for mouldings. Samples can be ordered on our website at www.larsonjuhl.co.uk.

Sustainability

At Larson-Juhl, we recognise the worldwide increase in environmental concerns about the sourcing of wood. In 2008, we were awarded the Chain of Custody Certification for both FSC (Forest Stewardship Council) and PEFC (Programme for the Endorsement of Forest Certification) schemes. Our certificate numbers are FSC: TT- COC-002824 and PEFC: BMT - PEFC -0682. This gives you the confidence that products carrying these labels are independently certified and managed to meet the social, economic and ecological needs of present and future generations.



Larson- Juhl has the widest range of FSC / PEFC mouldings in the industry and we will continue our focus on growing the number of sustainable products. We are currently working with suppliers to increase the range of certified products we offer and to ensure they're sourcing wood from environmentally sensitive sources.



Chop Service for Wood and Aluminium Mouldings

We offer a chop service on wood and aluminium mouldings, so you can choose to buy either in custom chopped or standard lengths.

Wood and aluminium mouldings are available in single length, pack and box quantity. Artcore is available in box quantity only.

Placing an order

The easiest and fastest way to place an order is on our website. Visit www.larsonjuhl.co.uk and log into your account. If you do not already have an account, please contact uksales@larsonjuhl.com

Our knowledgeable customer service team is available from 9.00am to 5.30pm on Monday and 9.00am to 5.00pm Tuesday to Friday.

UK and Ireland Sales Order Line: 01234 852777

UK and Ireland Sales e-mail: uksales@larsonjuhl.com

International Sales: +44 (0) 1234 846307

International Sales e-mail: export@larsonjuhl.com

Key

The symbols below describe the finish of each moulding, which you will find next to each moulding image along with the colour and measurements.

- AW Aluminium Wrapped
- BA Barefaced
- BR Brushed
- F Foil
- FL Faux Leather
- F/P Foil/Paint
- LQ Lacquer
- L Leaf
- LI Linen
- P Paint
- P/F Paint/Foil
- P/L Paint/Leaf
- SC Schaibin
- SP Spray
- S Stain
- V Veneer
- WB Wire Brushed
- WR Wrap
- WV Wood Veneer

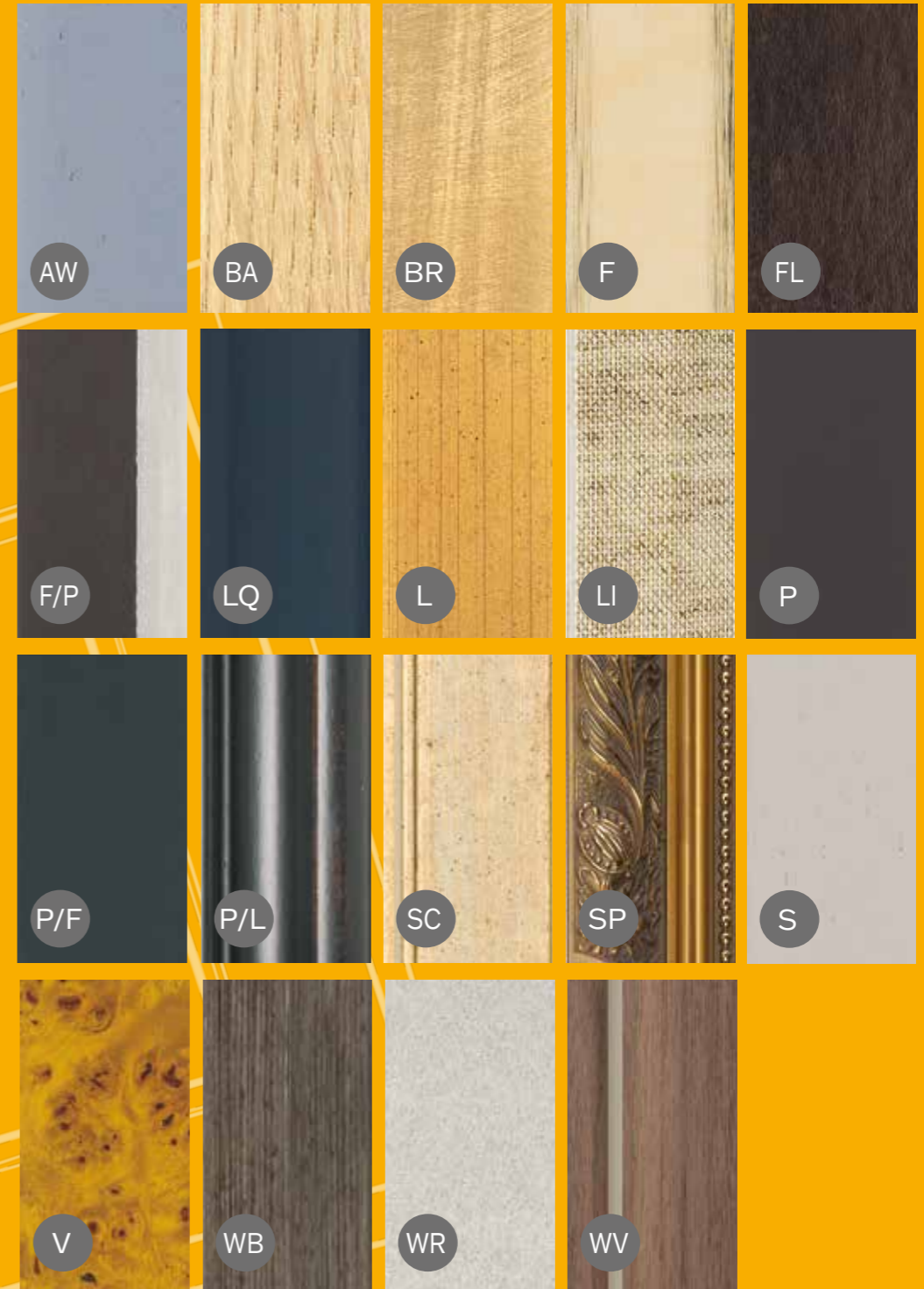



LARSON · JUHL
LJ

CONTENTS

Sustainability	10
Larson-Juhl Signature Collection	62
Plain Gold	176
Decorative Gold	200
Silver	214
Aluminium Wrapped Wood	236
Black	240
White	272
Colour	288
Coloured Lacquer	304
Plain and Decorative Wood	310
Natural Wood and Real Wood Veneers	330
Whitewashed/Natural and Honey Pine	344
Barefaced!	356
Slips and Spacers	372
Floats and Insets	378
Designer Moulding	394
Artcore	402
Ready Made Frames	410
Index	432

Conservation

Sustainability is a topic that we are incredibly passionate about at Larson-Juhl UK, and it is becoming ever-more popular with consumers too.

As a company, we believe in sustainable wood. We have the largest selection of FSC / PEFC certified mouldings for our customers and we will be increasing this offering in the coming years.

Sustainable

LARSON·JUHL®



FSC / PEFC Ranges

We currently stock over 300 mouldings that are FSC or PEFC approved, all of which are made using timber that has been lumbered in compliance with sustainable forestry policies and are also fully recyclable. These include Andover, Chaise Longue, Driftwood and many more.

Chain of Custody

Larson-Juhl has full chain of custody ensuring that timber is tracked through every step of the supply chain from forest to shelf. This provides third party certification that products originate from certified forests with an unbroken path to the customer.

Chop Service

Using our chop service allows customers to order the exact amount of moulding that they require, reducing wastage. Not to mention that it's easier for framers!

Customer Service Centre

Bedford Link Logistics Park achieves a BREEAM rating of Very Good. This reflects a high standard of design in the areas of energy use, transportation, treatment of ecology, minimisation of pollution, health and wellbeing, management of the specification and construction process, water use, materials selection, and waste in construction.

Alora FSC

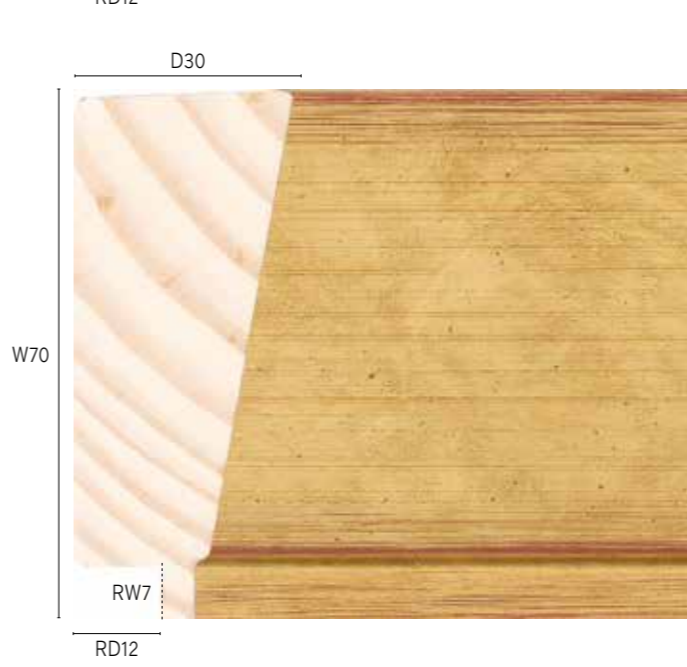
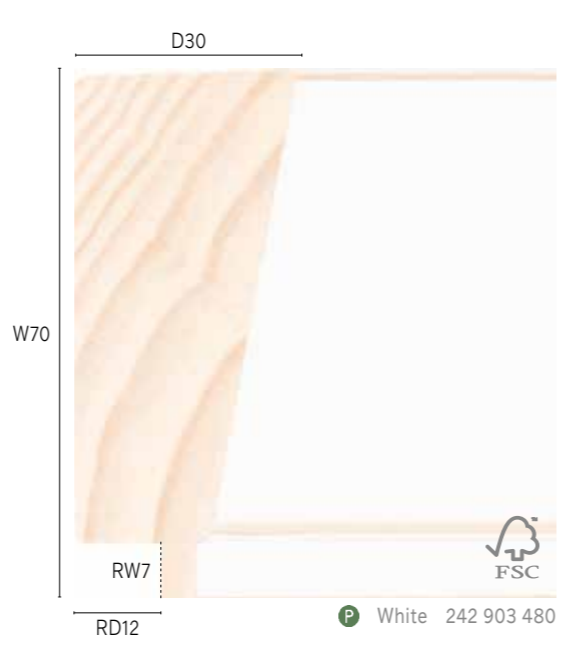
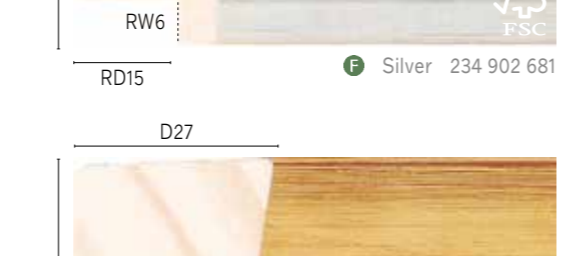
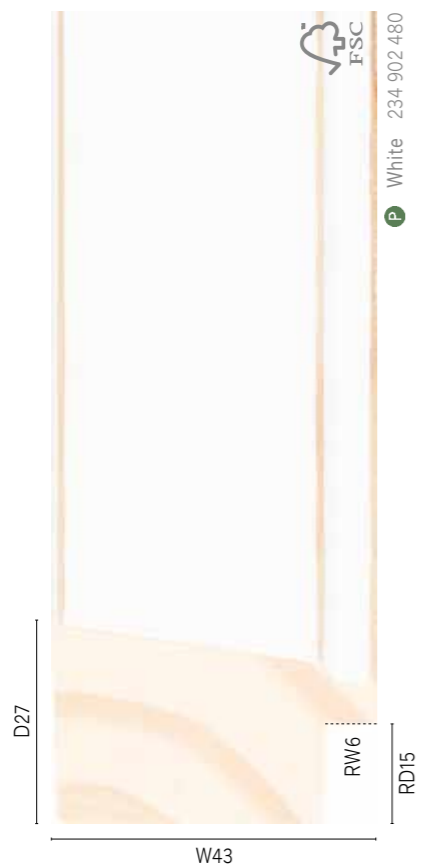
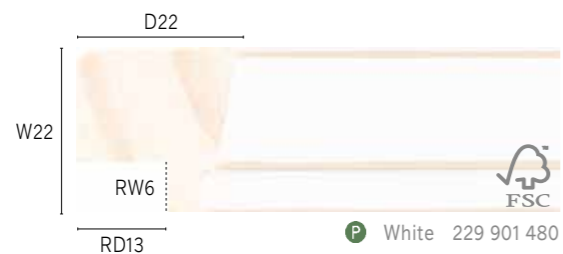

Andover FSC

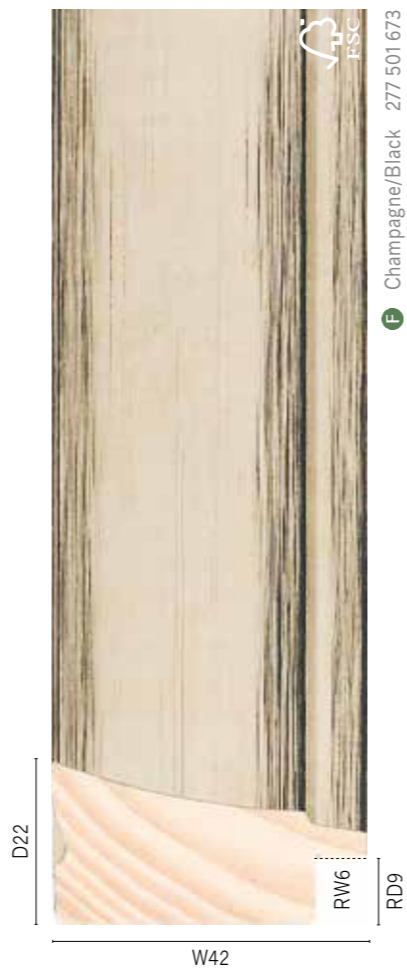
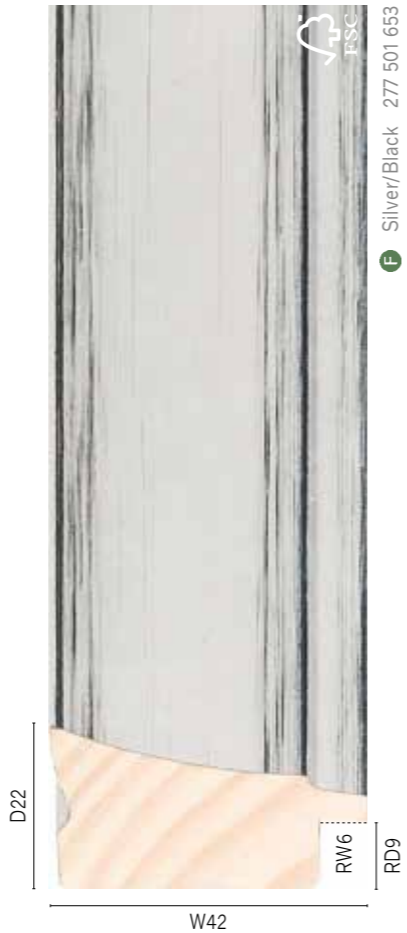
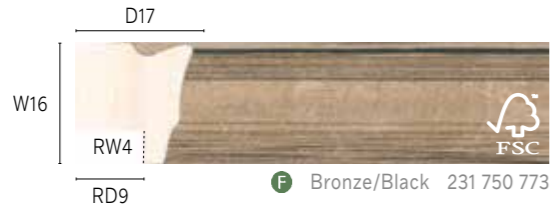
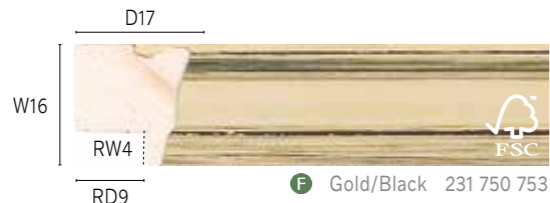
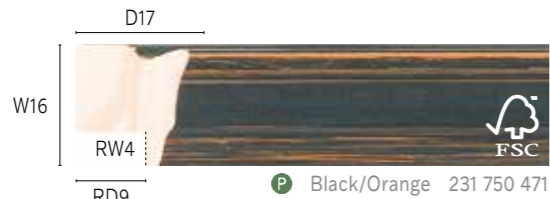

F Silver/Black 277 501 653

F Champagne/Black 277 501 673

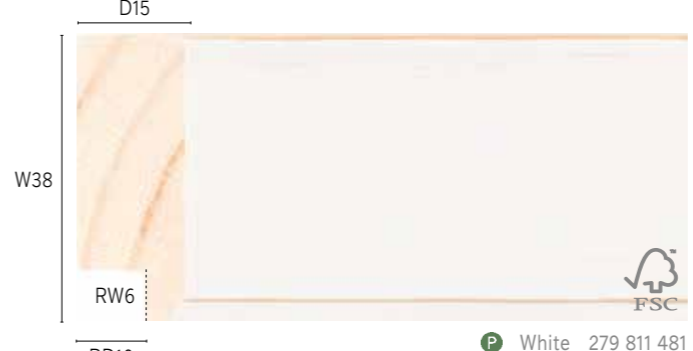

Andover FSC



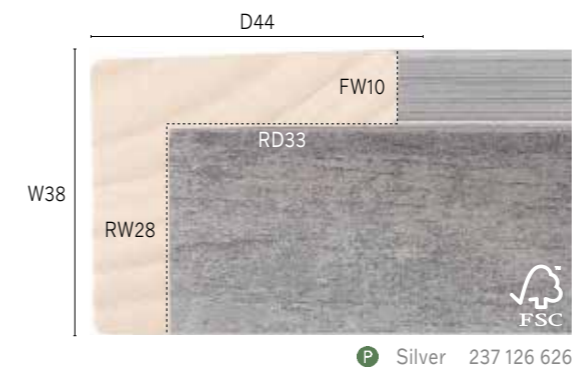
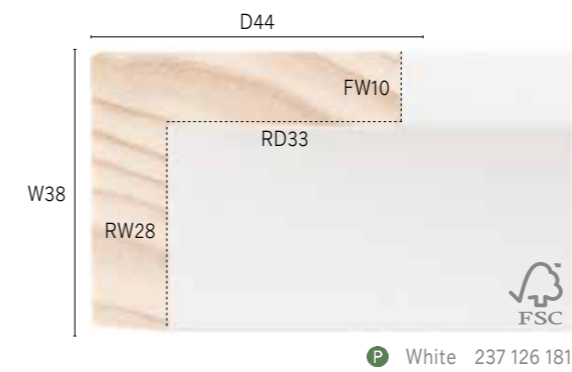
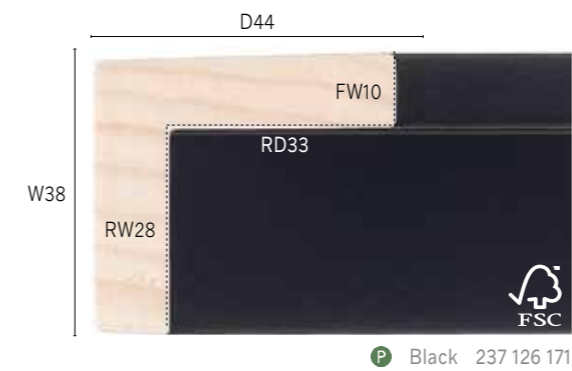
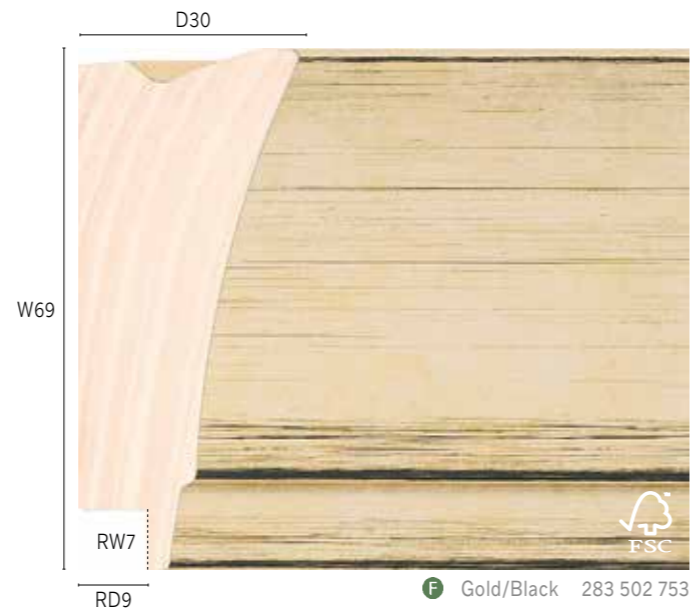



SUSTAINABILITY

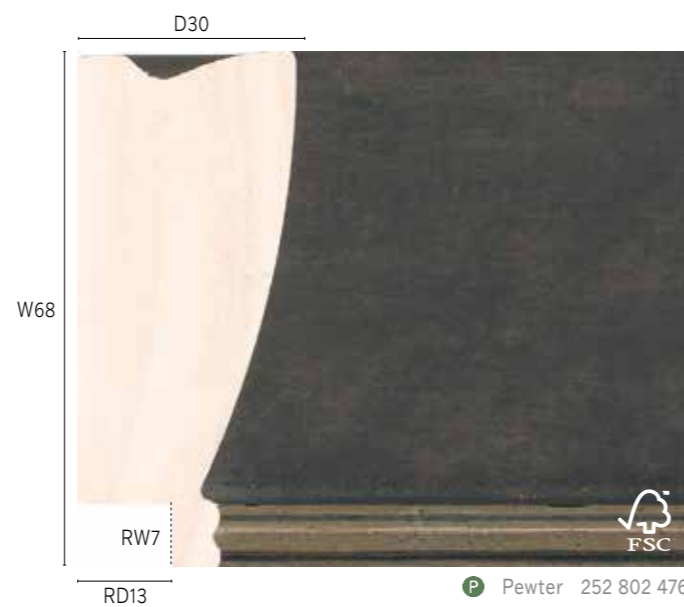
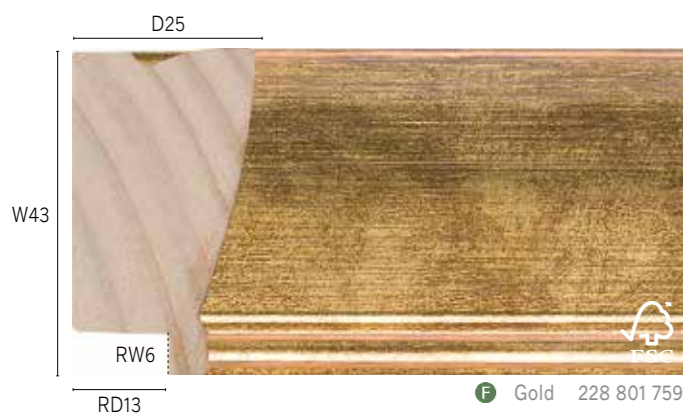

SUSTAINABILITY

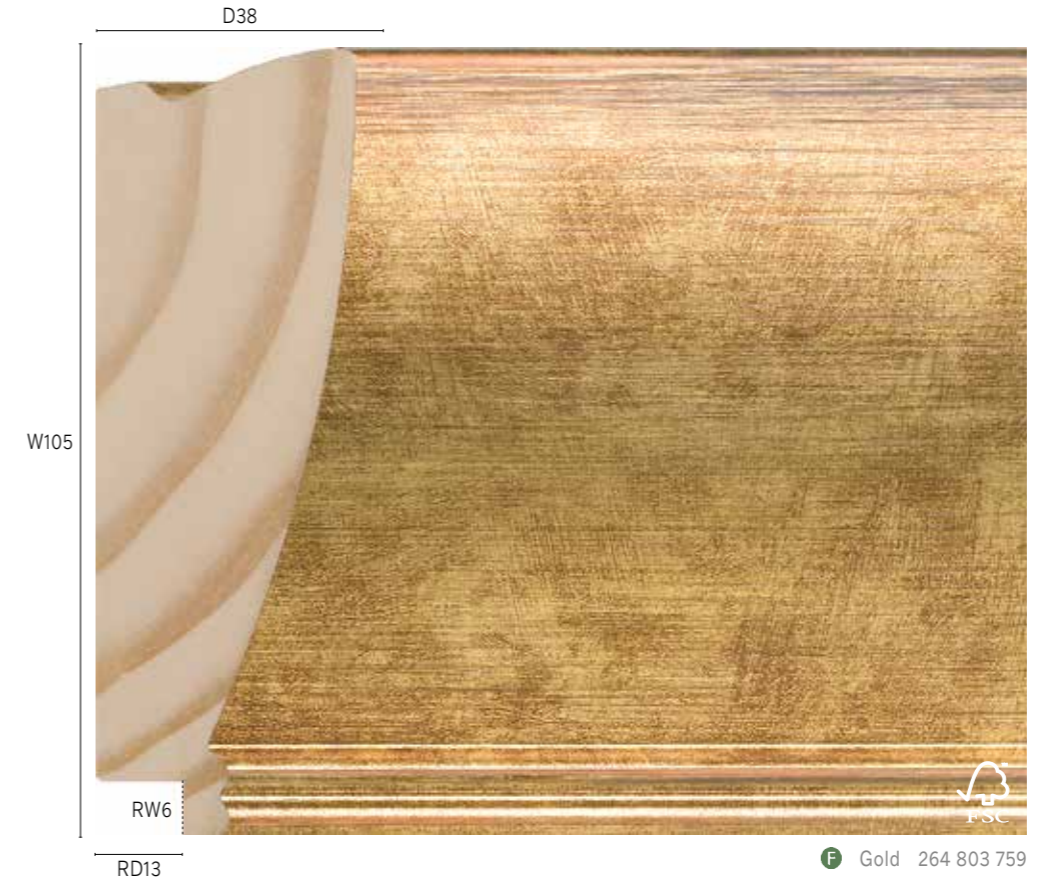

Chaise Longue FSC



The mark of responsible forestry



F Pewter 281 753 616



F Pewter 285 757 616



F Champagne 281 753 617

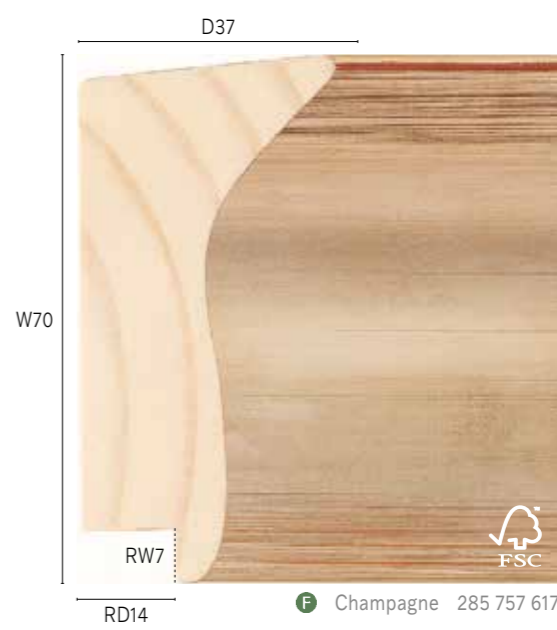

F Champagne 285 757 617



F Silver 281 753 662



F Silver 285 757 662



F Gold 281 753 717



F Copper 281 753 718



The mark of responsible forestry



F Light Copper/Silver 234 902 979



F Light Grey/Silver 242 903 973

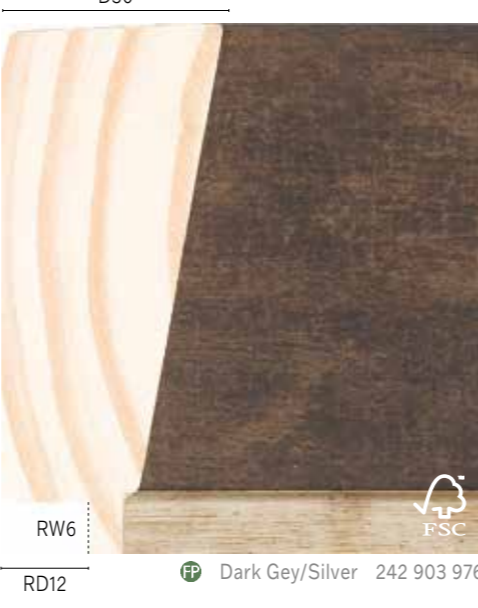

F Dark Grey/Silver 242 903 976



F Light Grey/Silver 229 901 973



F Dark Grey/Silver 229 901 976



P Light Copper/Silver 229 901 979



F Light Grey/Silver 234 902 973



F Dark Grey/Silver 234 902 976

Barranda FSC

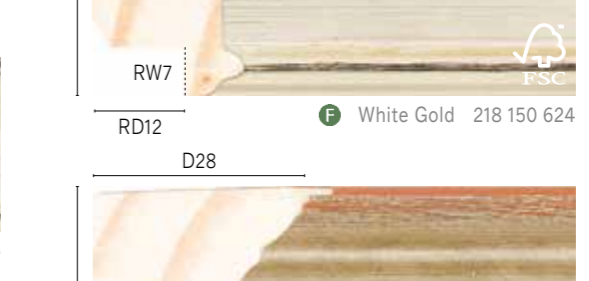
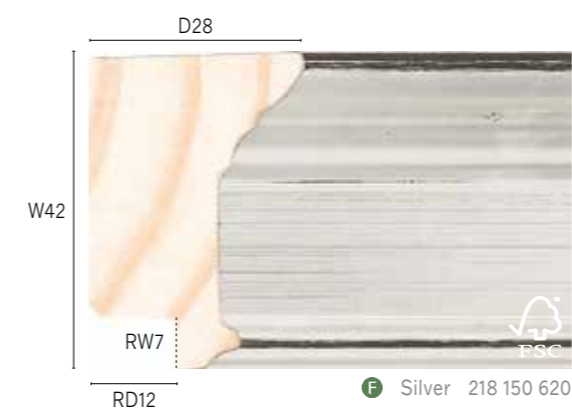

Geneva FSC

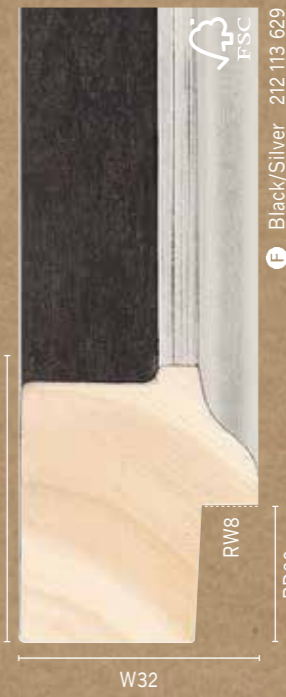
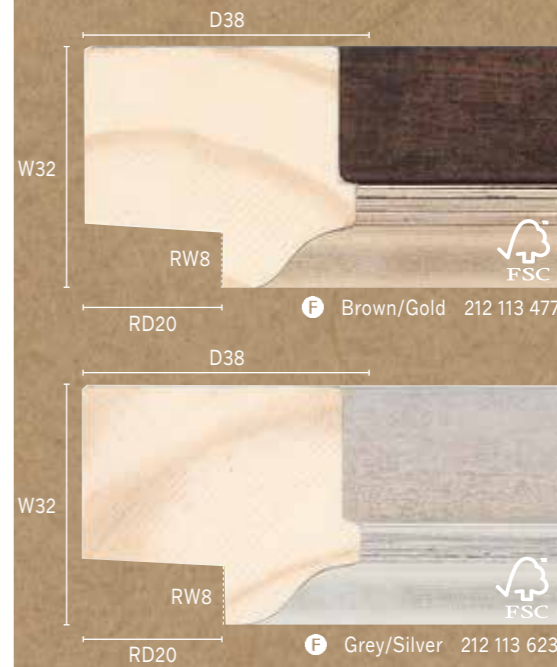

Driftwood FSC

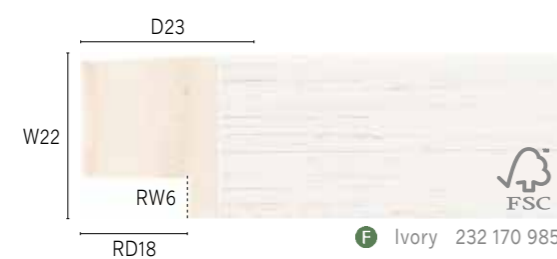



RW7

RD20

W105

D37

P Black/Orange 294 202 571



D30

W70

RW7

RD20



Hampshire FSC

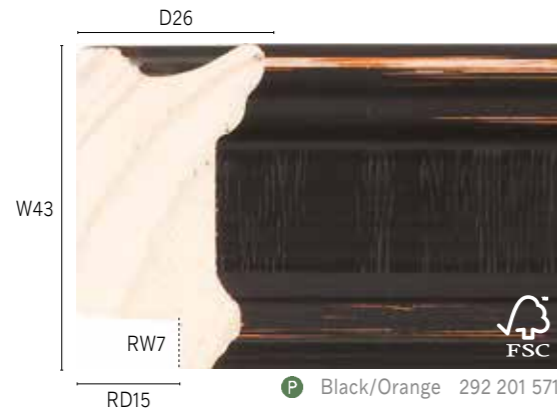

P Black/Orange 292 201 571



P Ivory 292 201 581

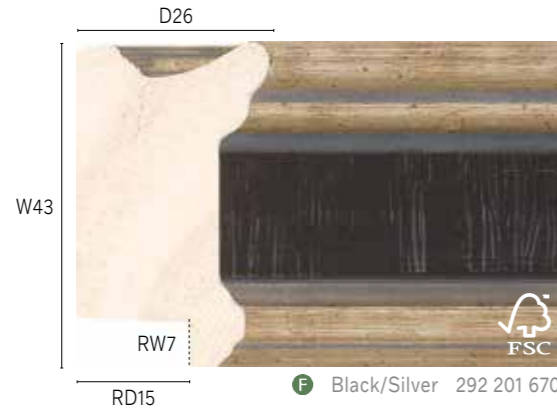

F Black/Silver 292 201 670



P Ivory 294 202 581



F Silver/Black 294 202 670

Hampshire II FSC

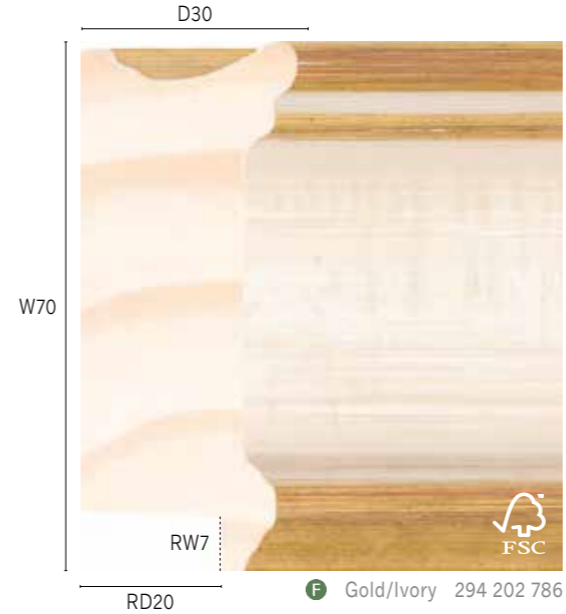
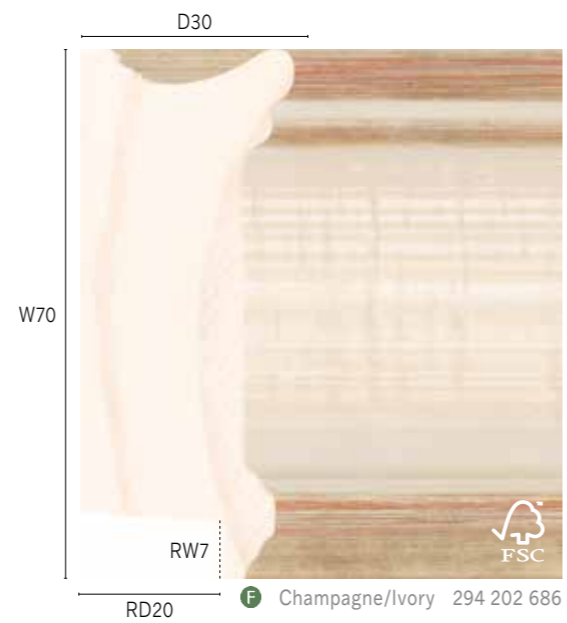
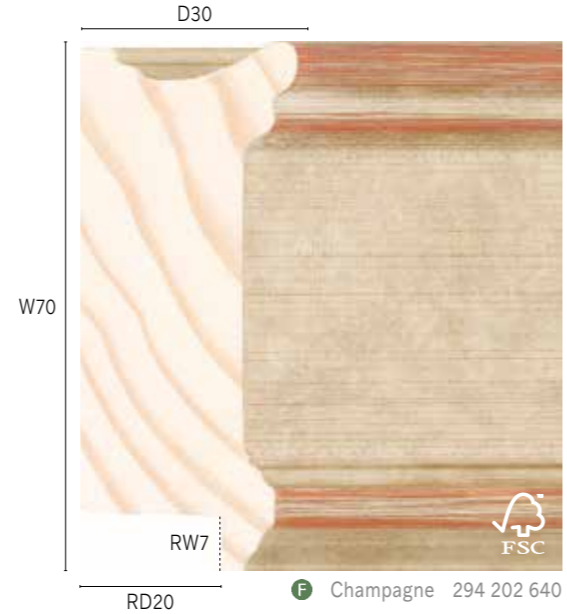
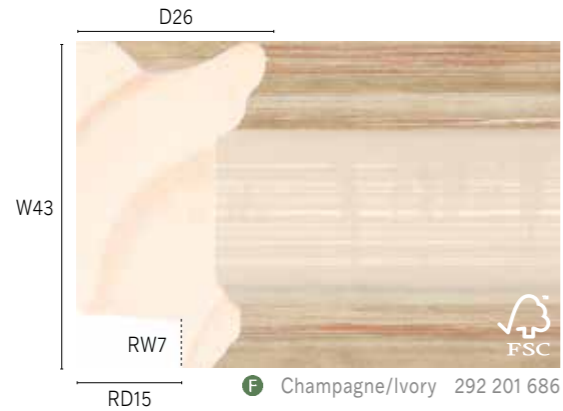

www.larsonjuhl.co.uk
sales order line - 01234 852777
uksales@larsonjuhl.com

www.larsonjuhl.co.uk
sales order line - 01234 852777
uksales@larsonjuhl.com

Lula FSC

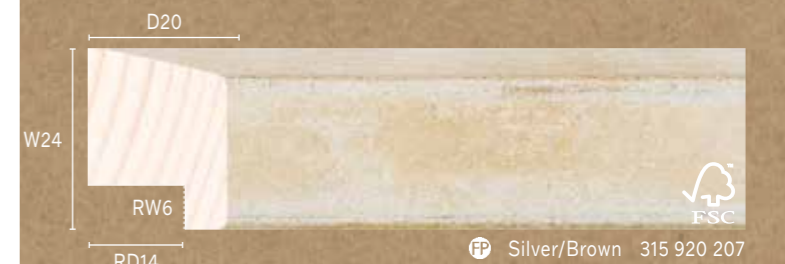
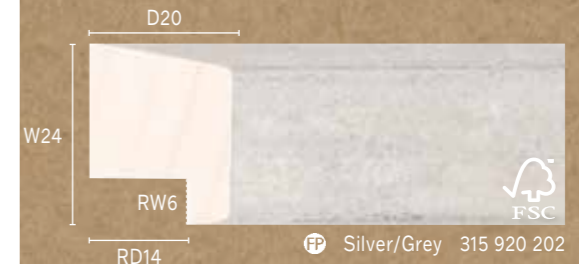

Mosaic FSC



Murcia FSC

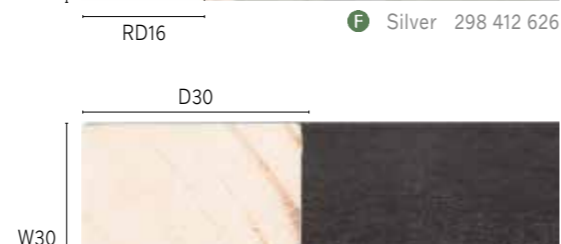
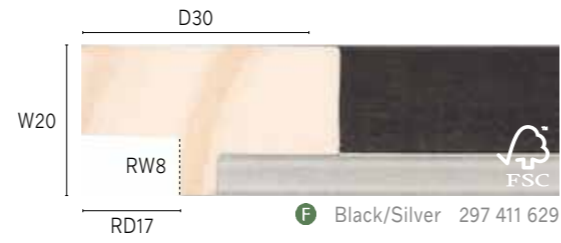

Murcia FSC

Navarra FSC

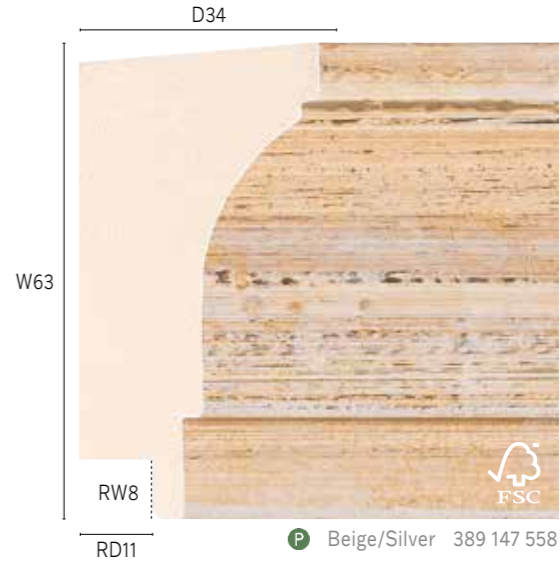
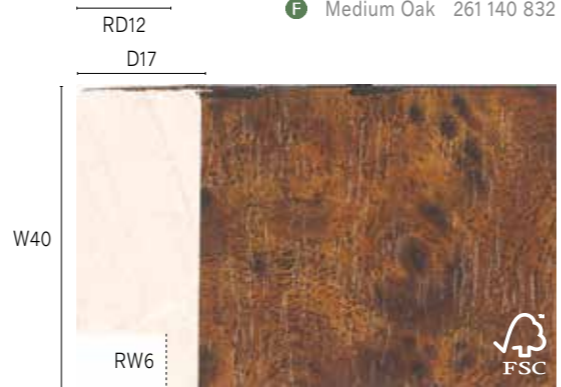

Nuoro FSC



The mark of responsible forestry

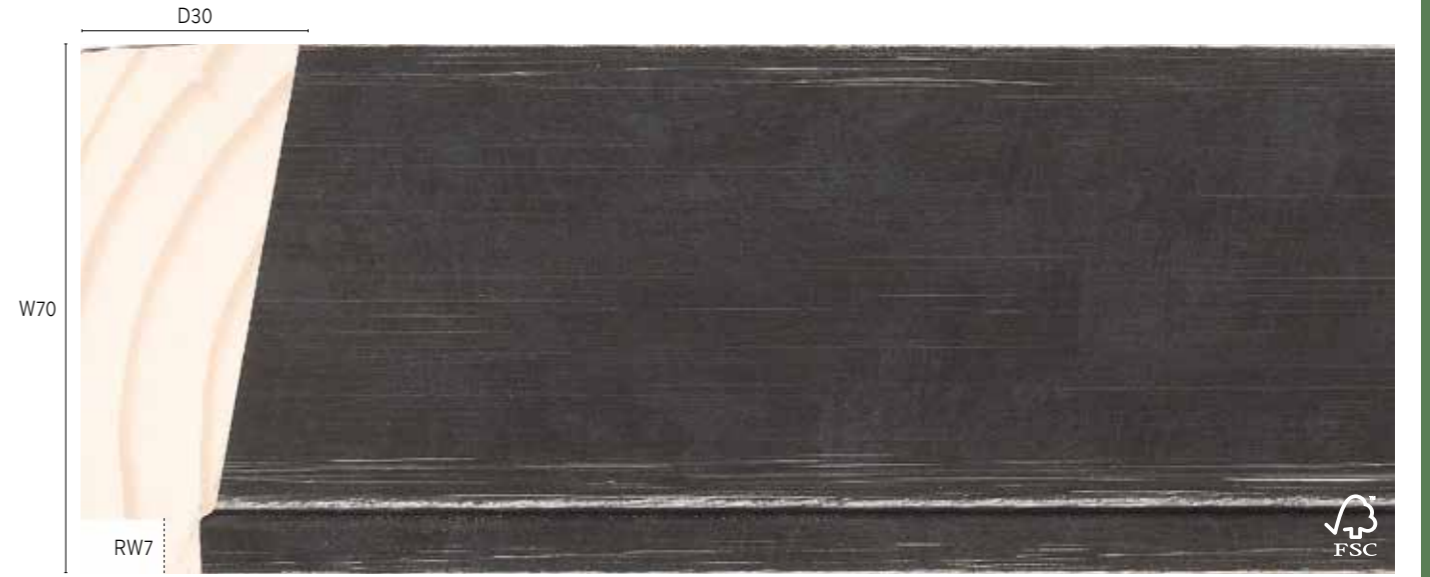

Black/Grey 242 903 870



Grey 242 903 982



Silver 242 903 986



The mark of responsible forestry



Black/Grey 234 902 870



Grey 234 902 982



The mark of responsible forestry



Silver 234 902 986



The mark of responsible forestry

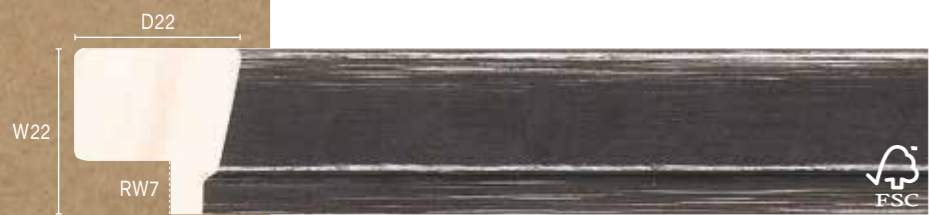

Black/Grey 229 901 870



Grey 229 901 982



Silver 229 901 986



D27

W43

RW6

RD15

Silver 234 902 986



The mark of responsible forestry

Pedraza FSC

Provence FSC

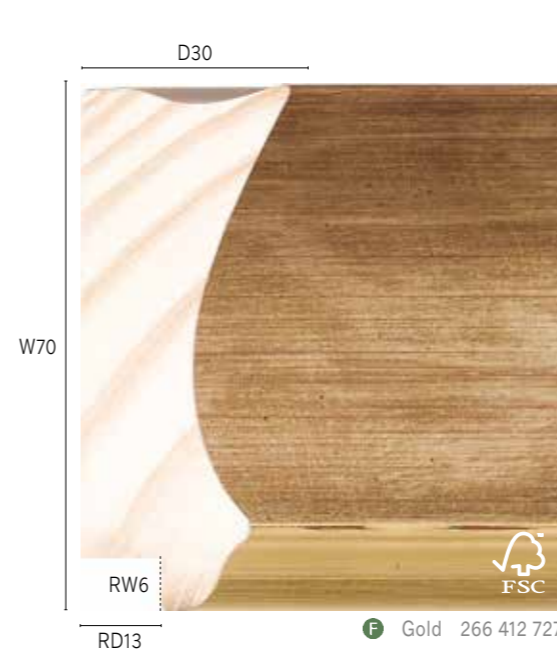
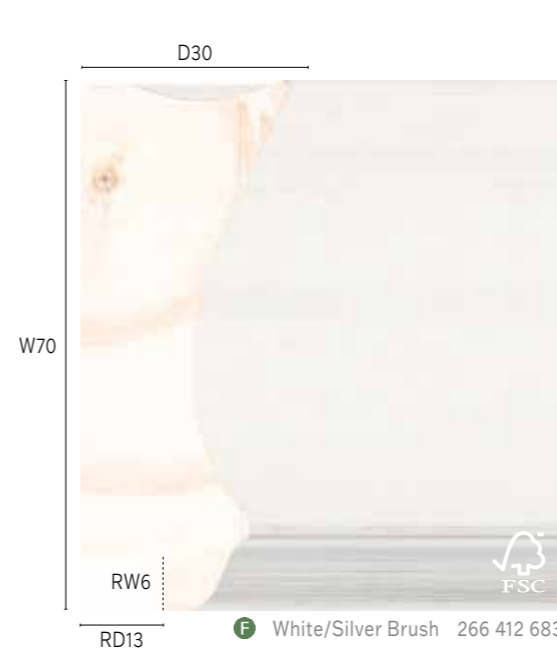
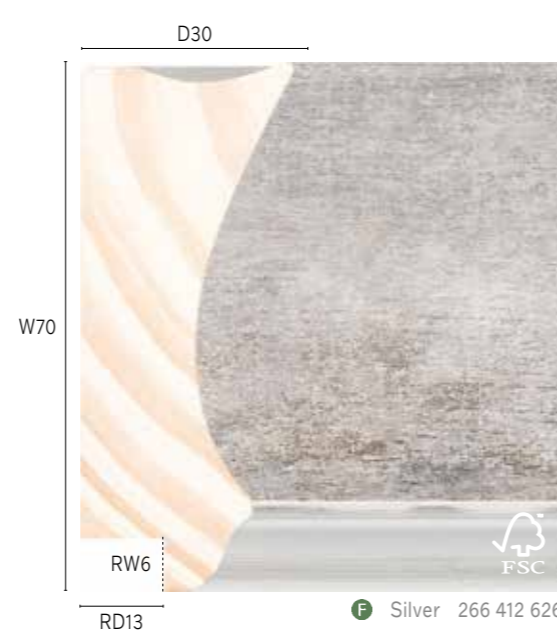
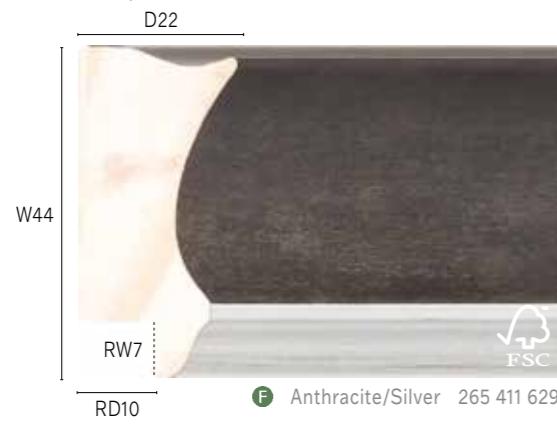

* 267 413 727 shown at 90% of actual size

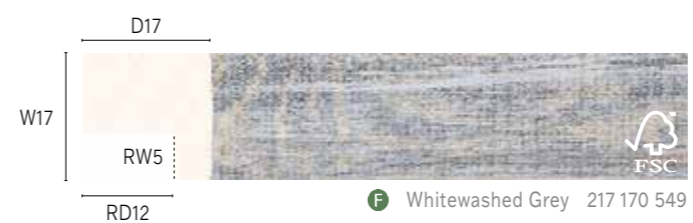

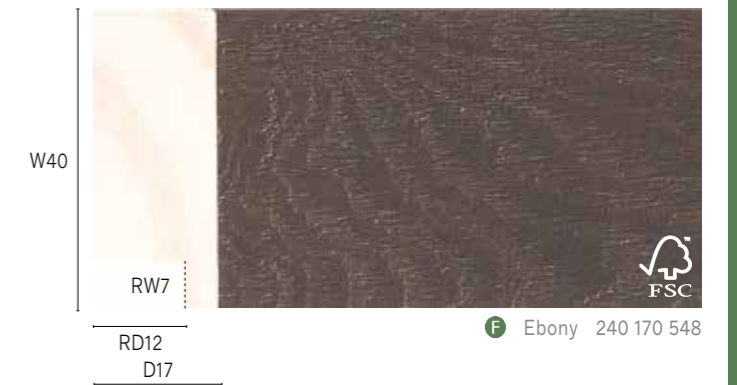
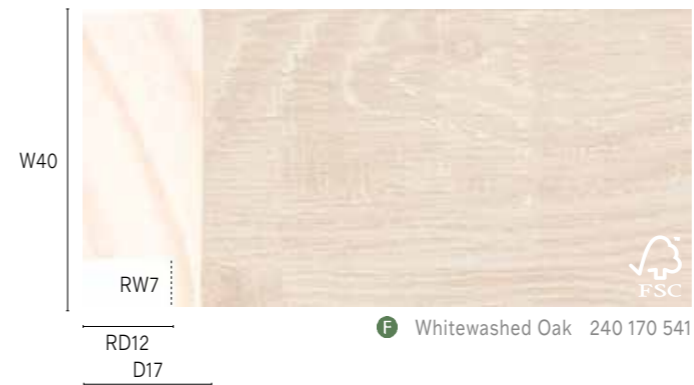
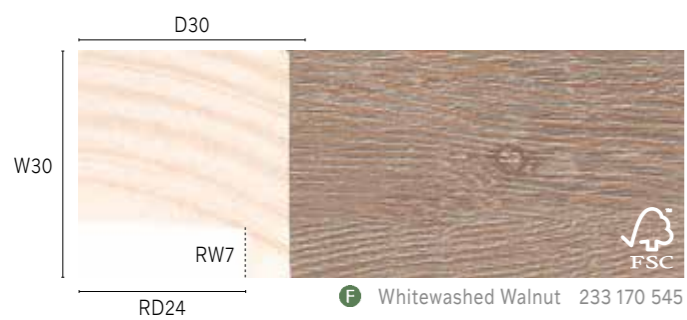
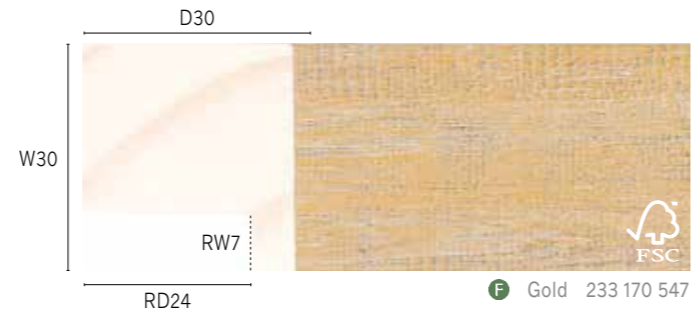

Barefaced! Lime FSC

Barefaced!



D27	W21	RW6	RD21 D21	103 800 000
W21	RW6	RD16	D34	114 800 000
W21	RW6	RD29 D22		155 800 000
W11	RW4	RD7 D12		159 800 000
W12	RW5	RD8	D39	202 800 000
W21	RW6	RD34 D31		211 800 000
W16	RW5	RD26		385 800 000



D28	W43	RW6	RD12	F Gold 210 064 714
D28	W43	RW6	RD12	F Silver 210 064 613
D28	W43	RW6	RD12	F Pewter/Silver 210 064 614
D28	W43	RW6	RD12	F Black/Silver 210 064 615
D28	W43	RW6	RD12	F White/Silver 210 064 681

Torre FSC

Barefaced! Pine FSC

Barefaced!

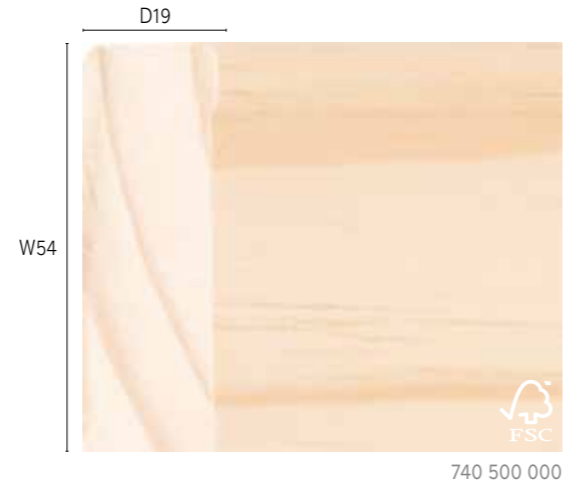

Barefaced! Pine FSC

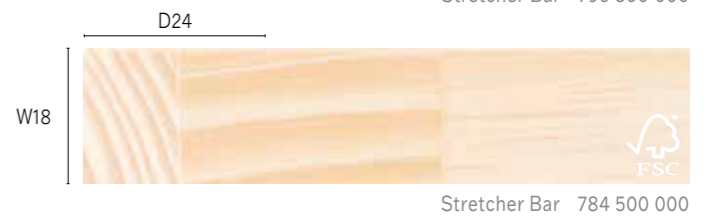

Barefaced! Pine PEFC

Barefaced!



Subframe 594 500 000



Subframe 596 500 000

Caserta PEFC

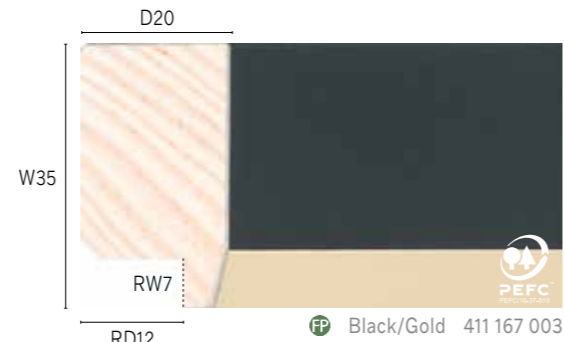

Black/Gold 411 167 003



Black/Silver 411 167 007

Anvil PEFC



Aged Steel 288 615



Aged Steel 288 620

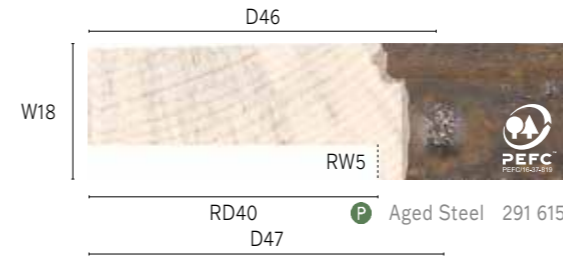

Aged Steel 291 615



Aged Steel 291 620



Aged Steel 460 620



Oiled Steel 289 630

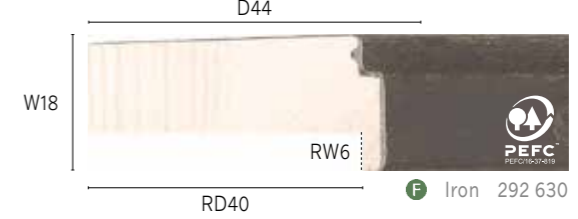

Iron 292 630

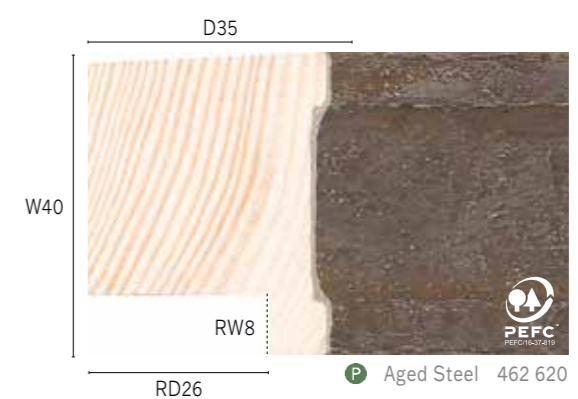

Aged Steel 462 620

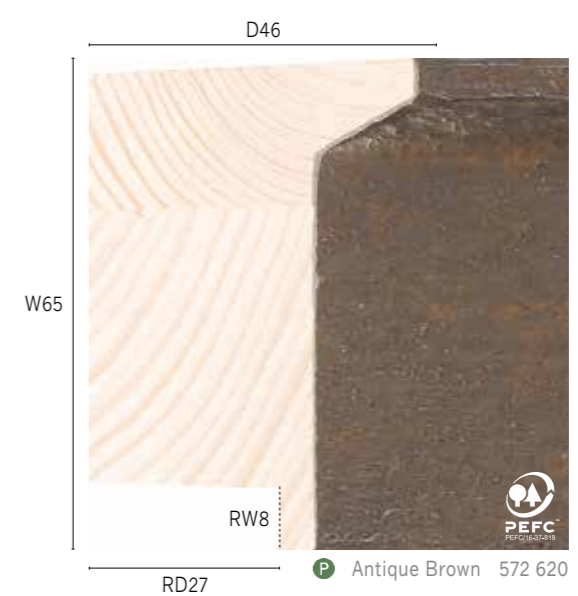

Antique Brown 572 620



Anvil II PEFC

Brittany PEFC

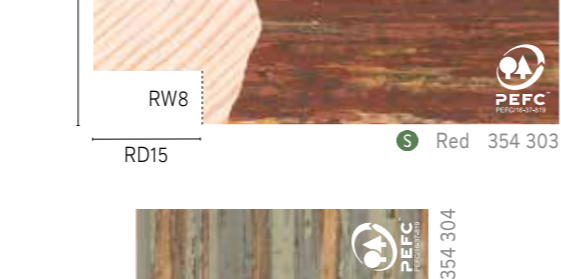
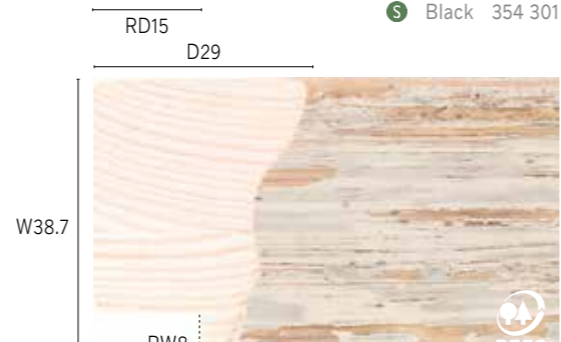
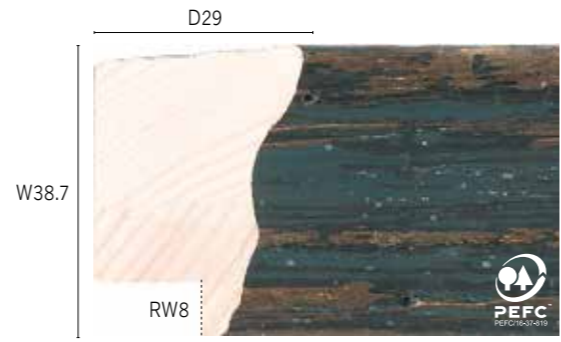
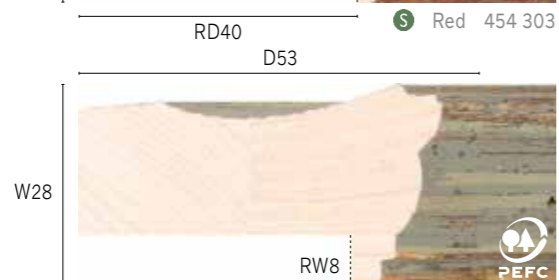
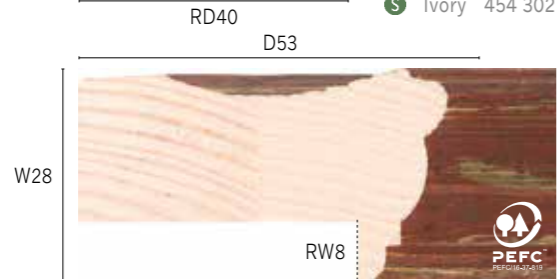
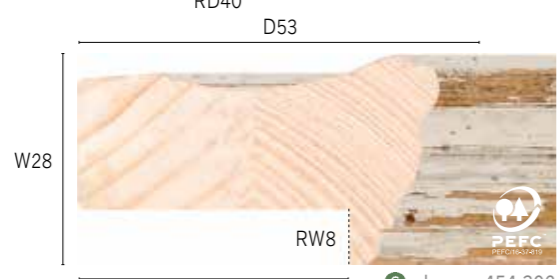
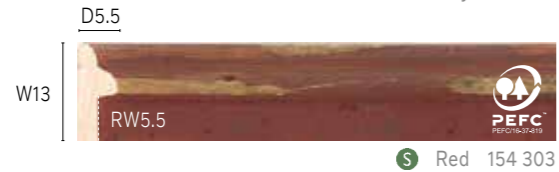
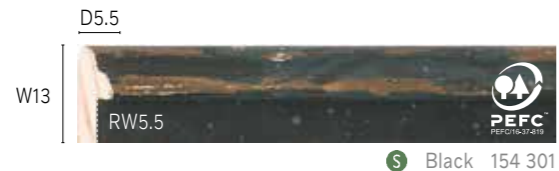

Dresden PEFC

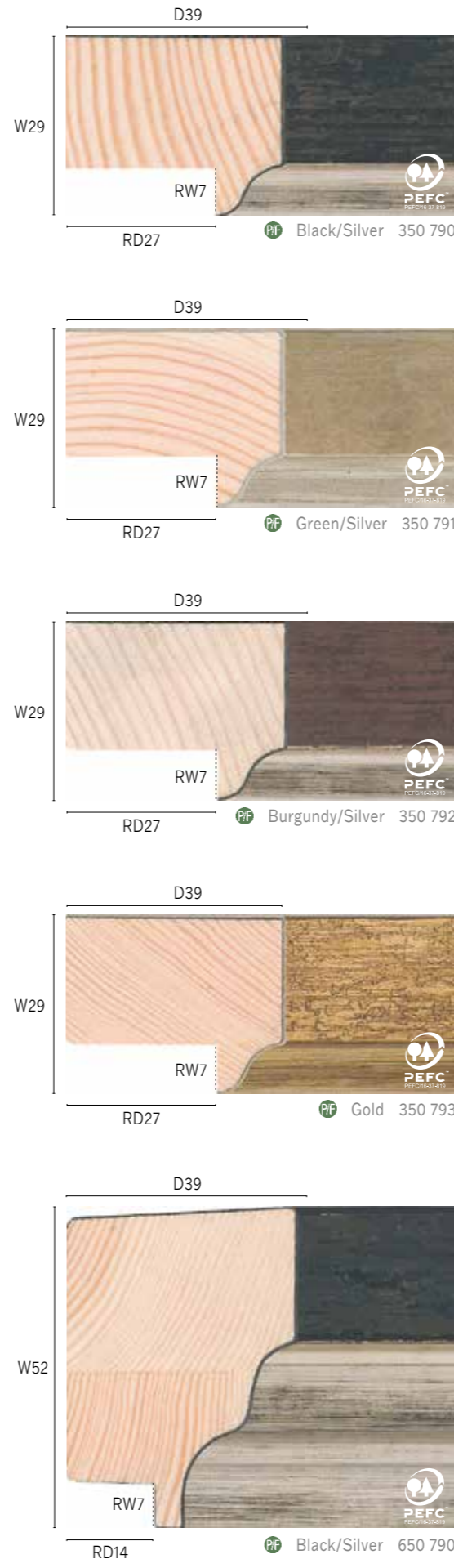
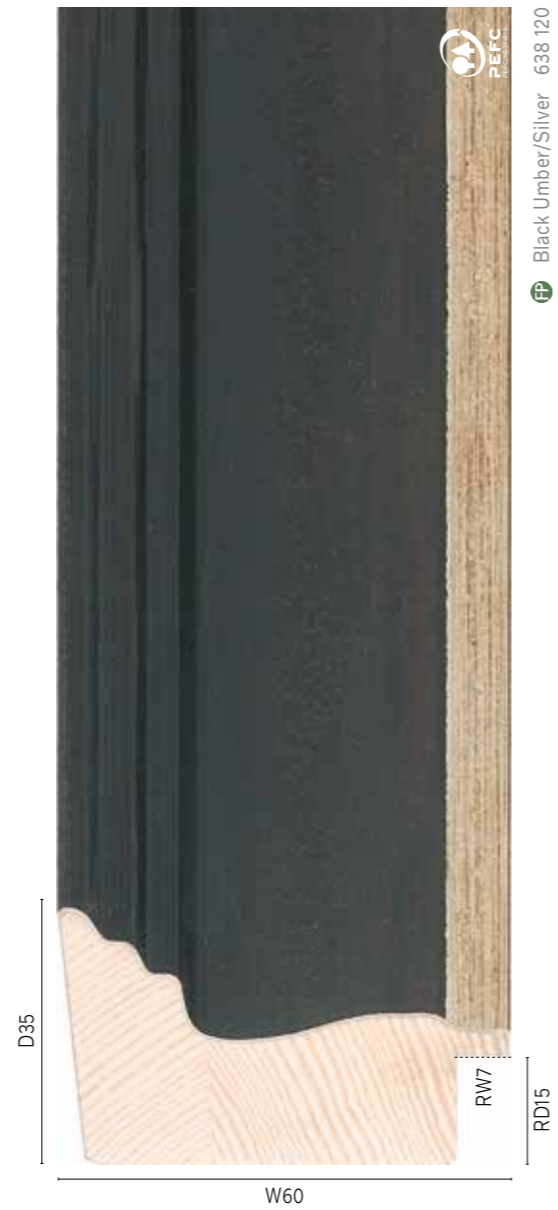
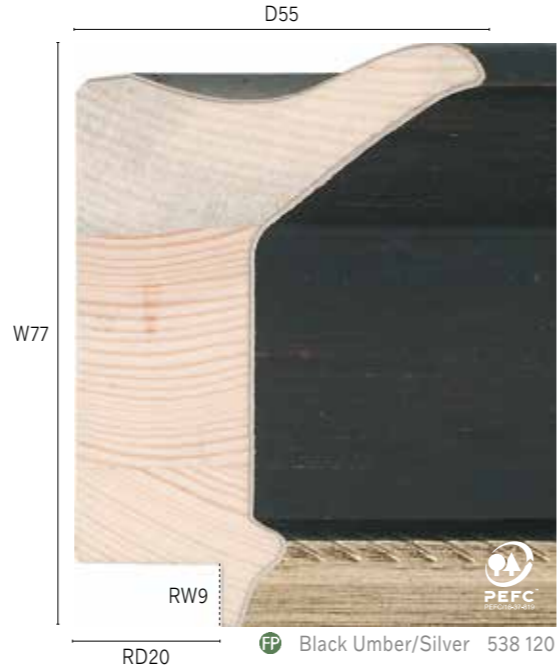

Lucerne PEFC

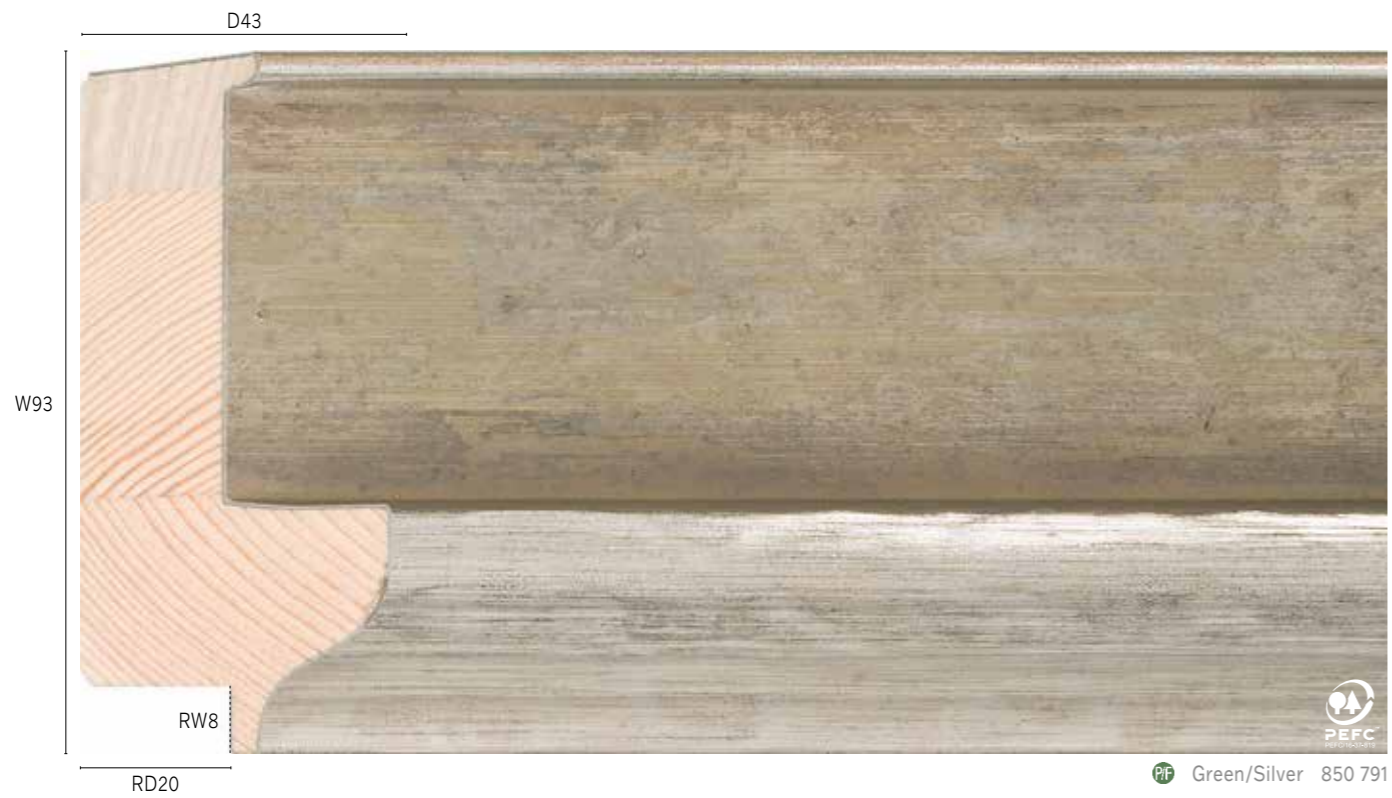

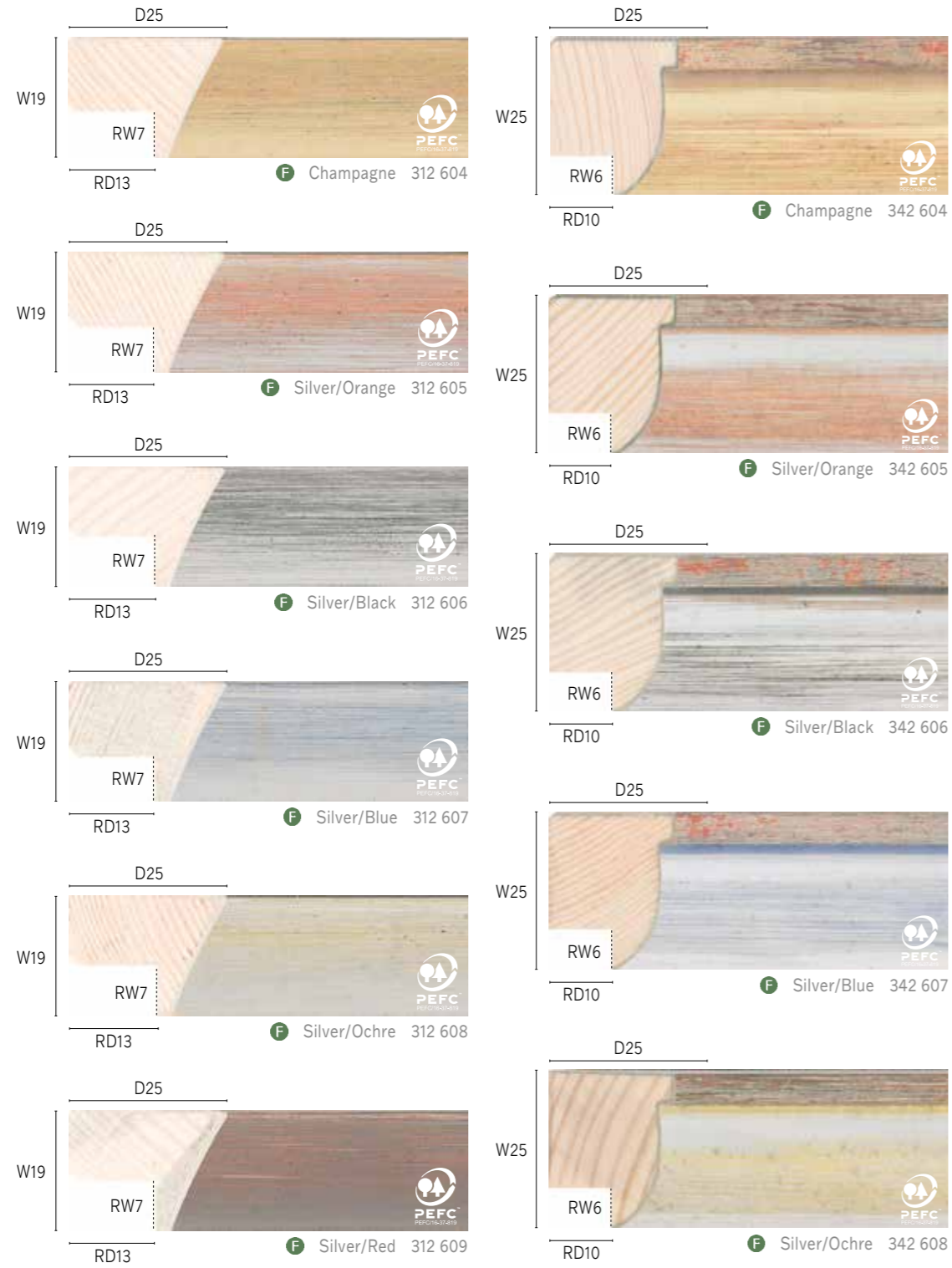
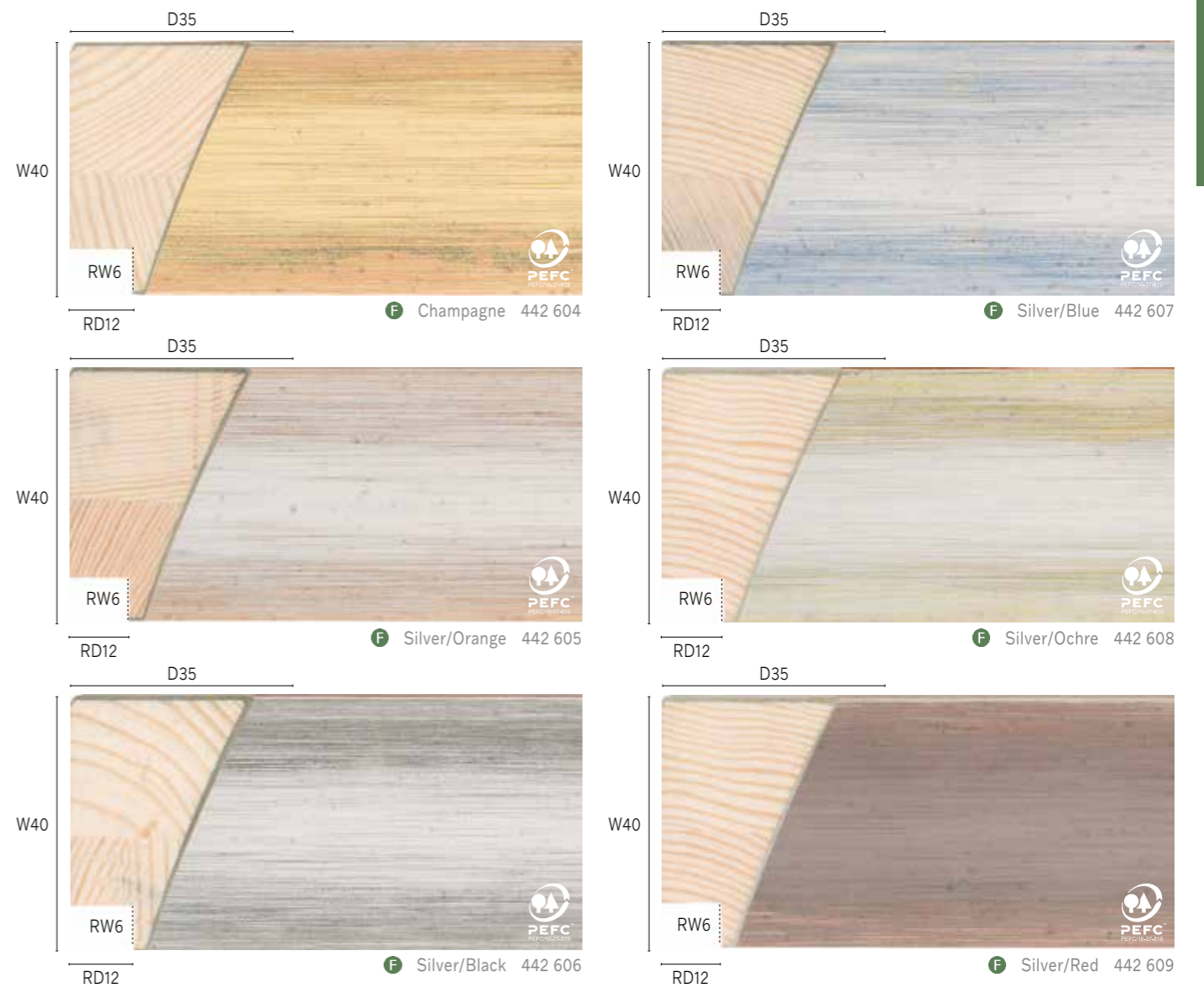

F Silver/Red 342 609

Mantilla PEFC

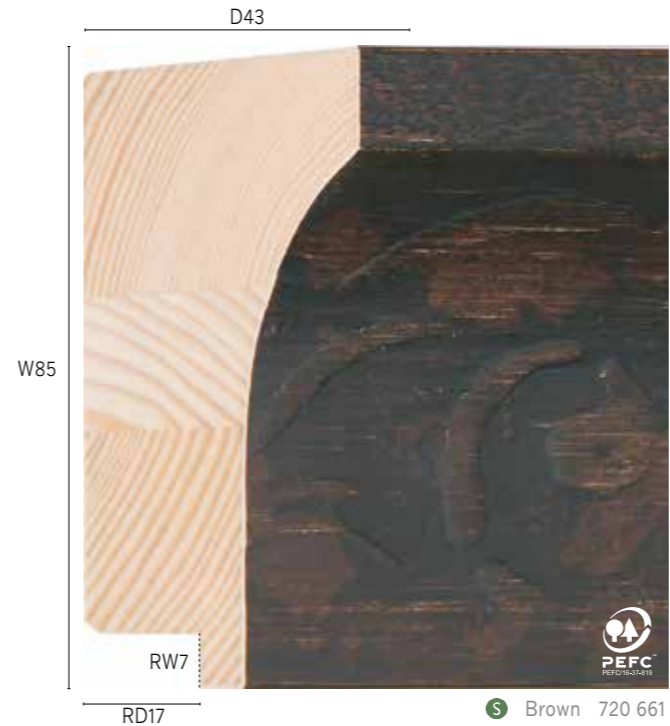

Zen PEFC

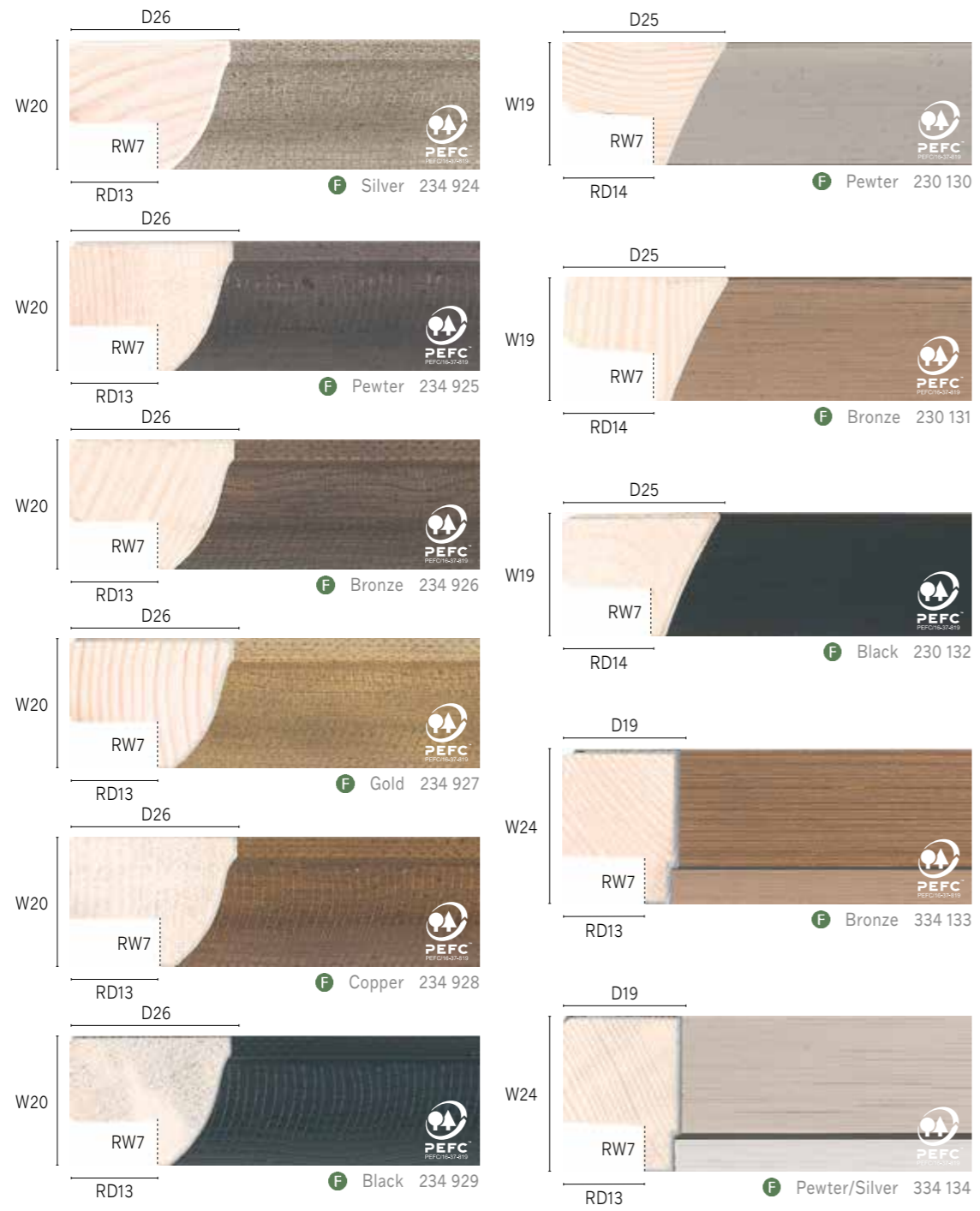
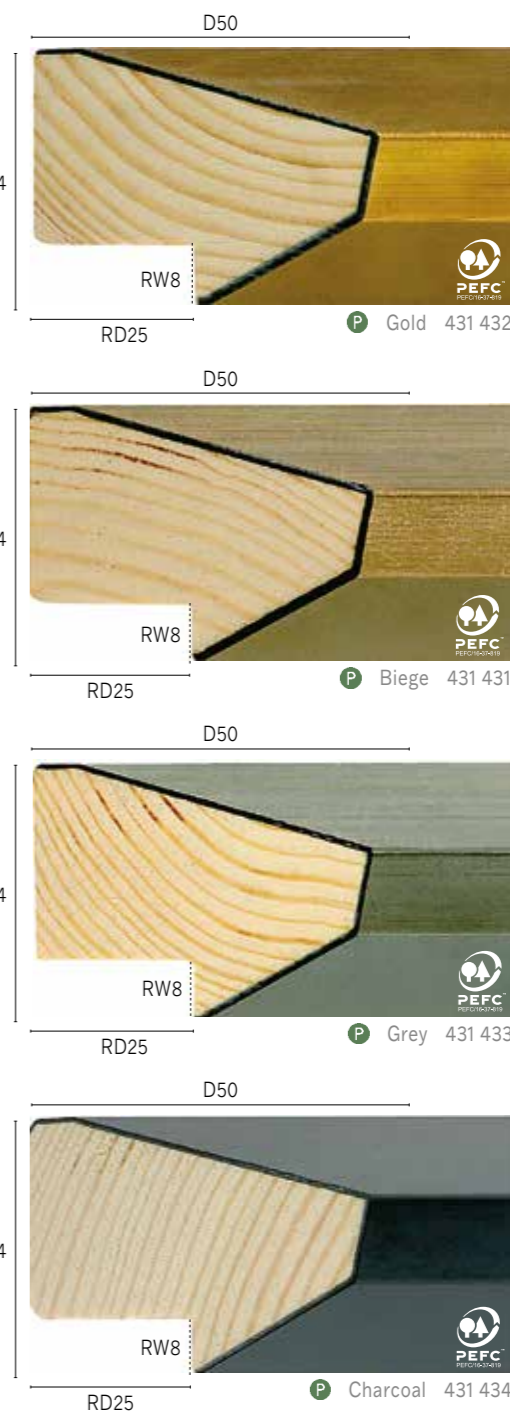

Petite PEFC



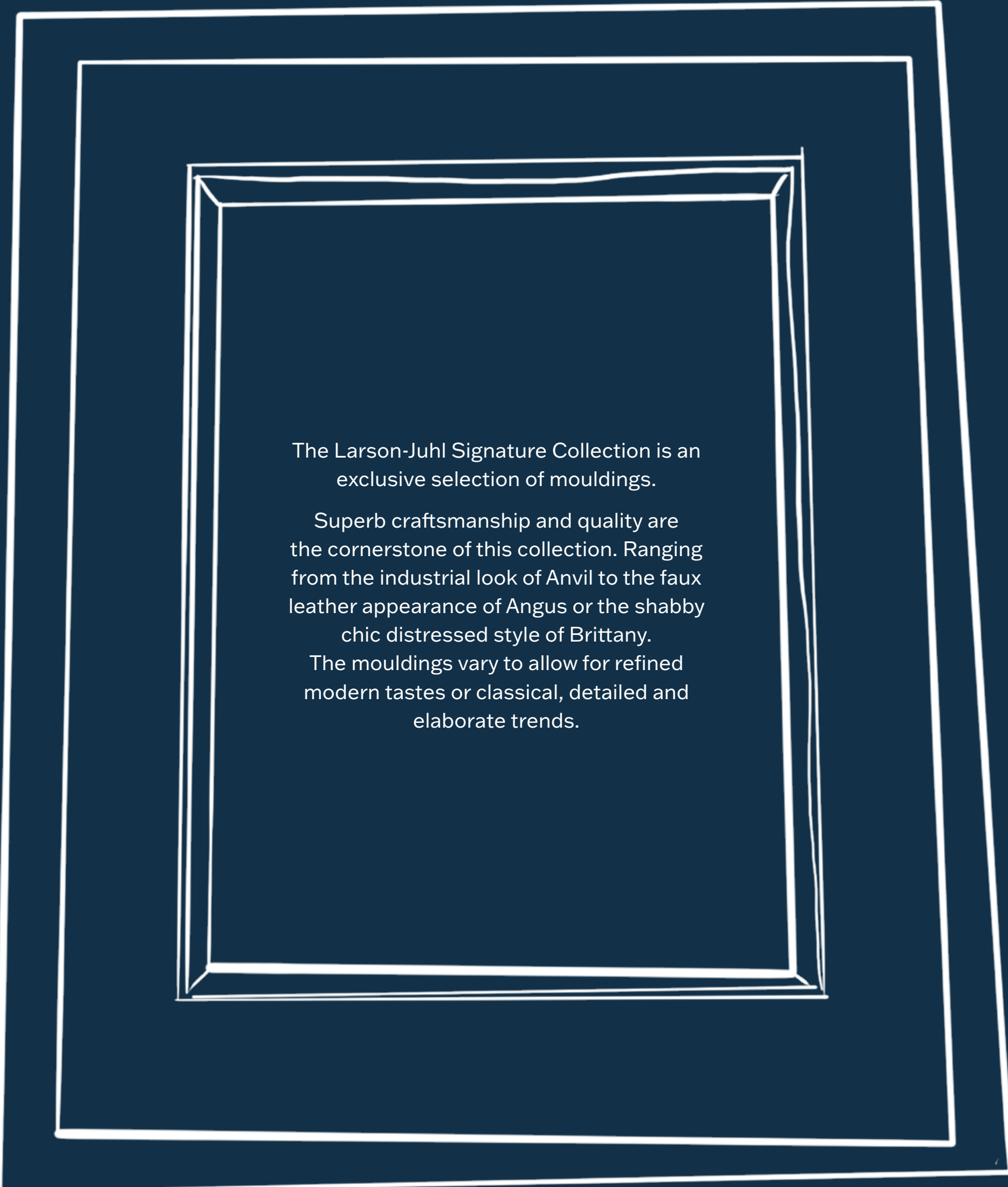

The Larson-Juhl Signature Collection is an exclusive selection of mouldings.

Superb craftsmanship and quality are the cornerstone of this collection. Ranging from the industrial look of Anvil to the faux leather appearance of Angus or the shabby chic distressed style of Brittany.

The mouldings vary to allow for refined modern tastes or classical, detailed and elaborate trends.

Larson-Juhl Signature Collection



Angus

Angus comes in a luxurious leather like full wrap, durable and easy to work with. The material is stained and embossed to further its leather appearance, the look of fine aged leather. The finish is complex and very light reflective with a beautiful wax finish to further enhance its appeal.

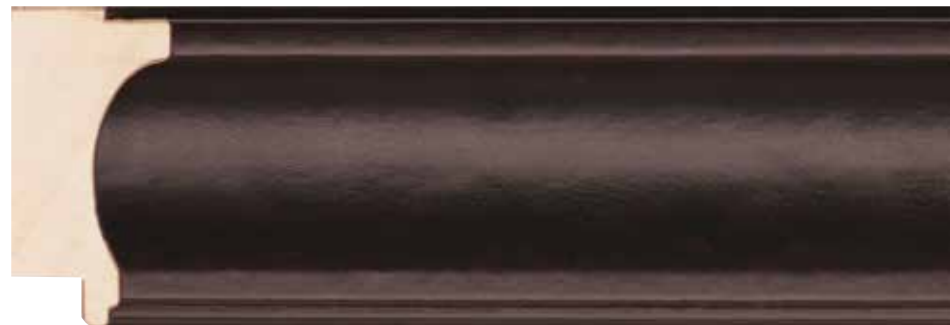

Moulding used
862 421/852 421

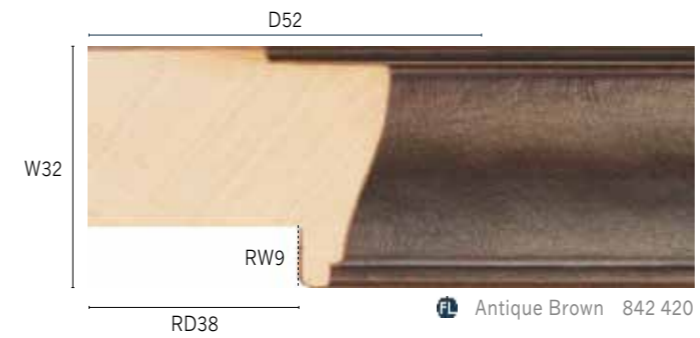

Antique Brown 842 420

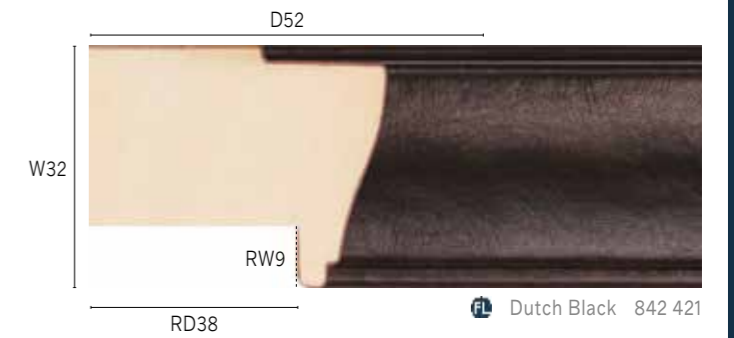

Dutch Black 842 421

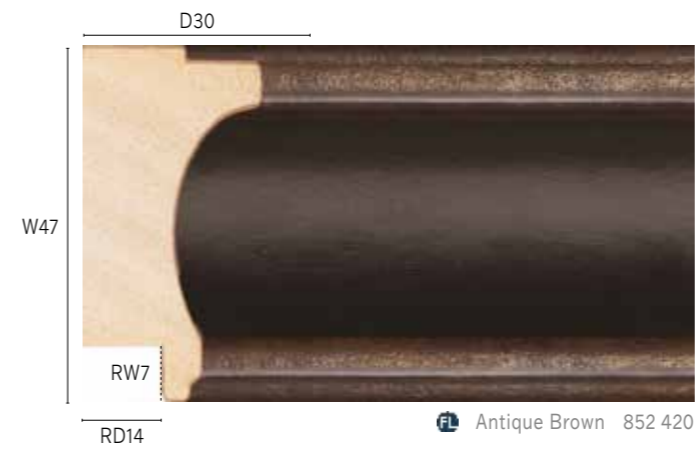

Antique Brown 852 420

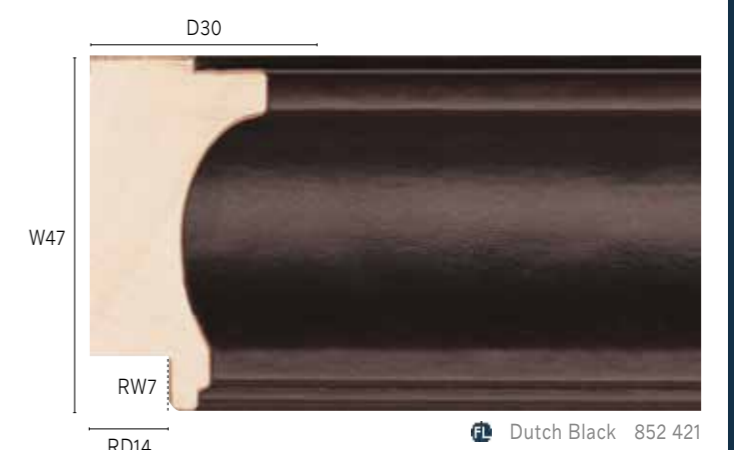

Dutch Black 852 421



Antique Brown 862 420

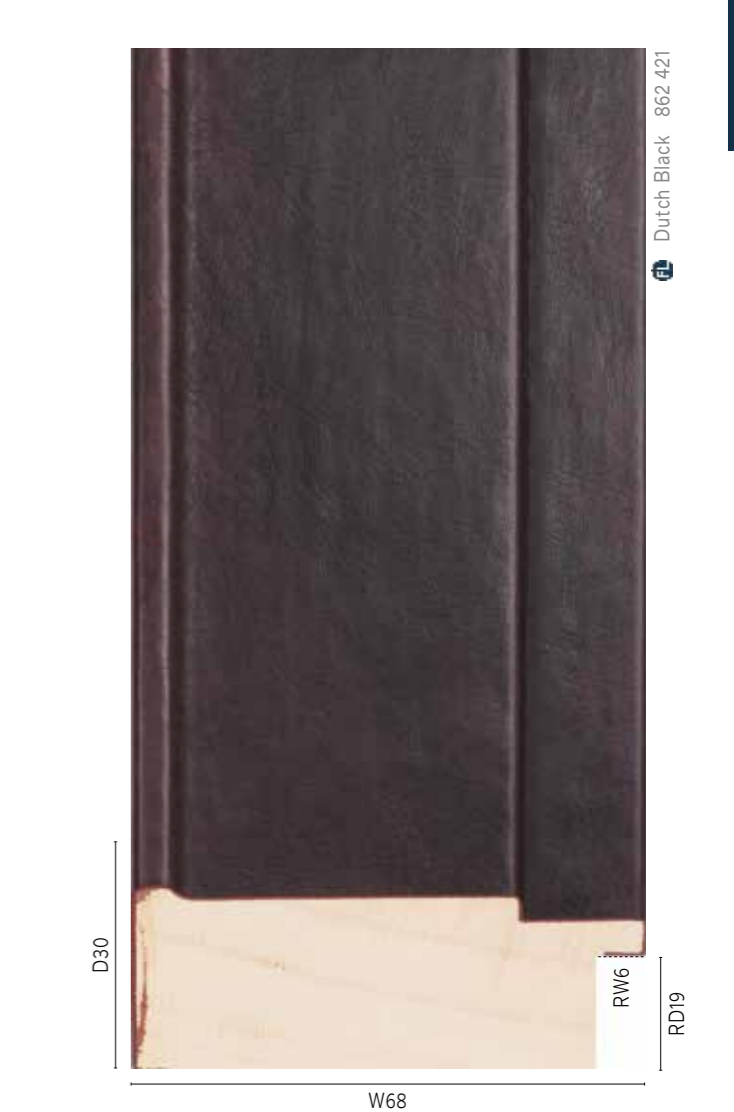

Dutch Black 862 421

Anvil and Anvil II



Anvil offers a forged look or the look of reclaimed metal with a design element that enhances all types of home décor. Much care has been taken to also offer small hints of reflective light on the high spots to again enhance the real look of metal. Designed to pair with raw woods, the metal accents offer a hint of light and texture to simple wood collections.

The oiled steel finish has been toned to work well with black and white photography and offer a new option to those who prefer not to use black. The two classic finishes can be paired with the bolted or angle iron accents enhancers or caps, or used as stand alone for the industrial look.

Moulding used

292 630

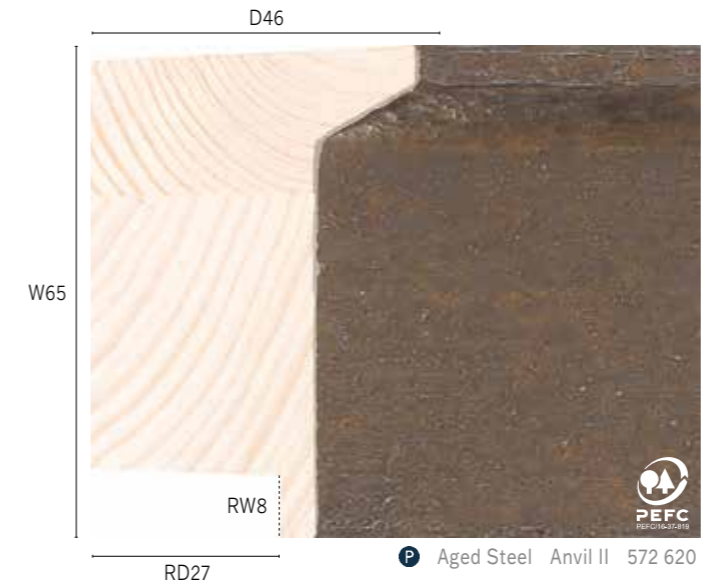
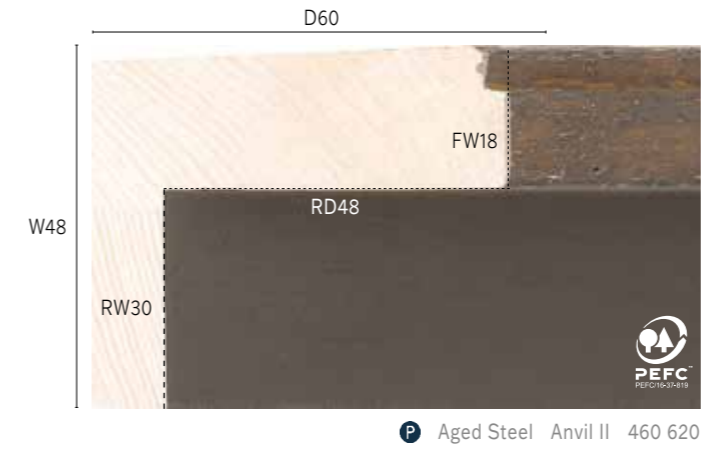
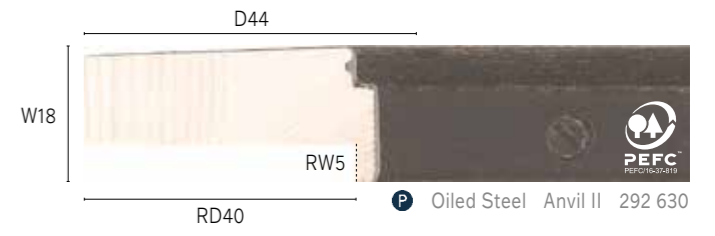
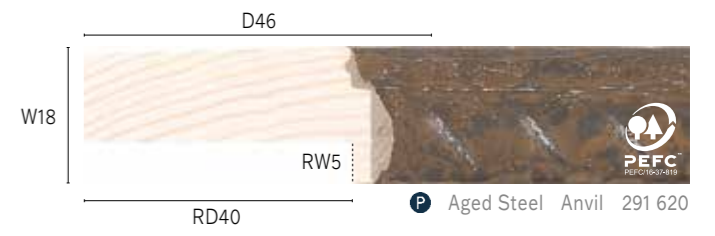
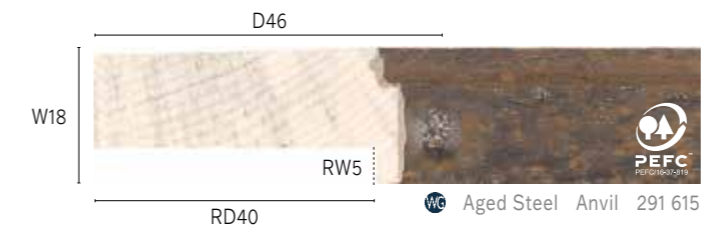

Aurora



Our Aurora collection is inspired by the natural light display of the northern and southern lights in the earth's night sky. With contrasting light and dark tones, they will complement a wide variety of artwork.

Moulding used
804 390

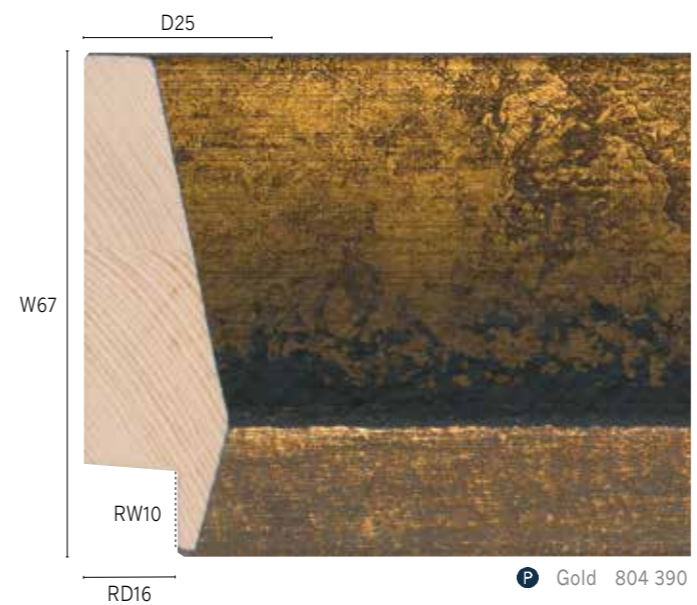
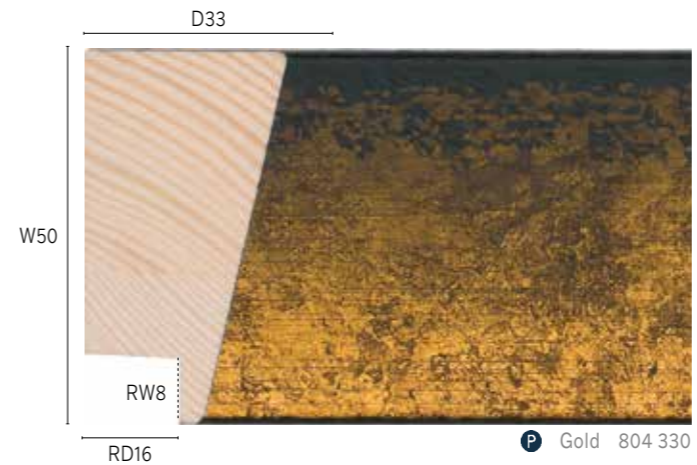
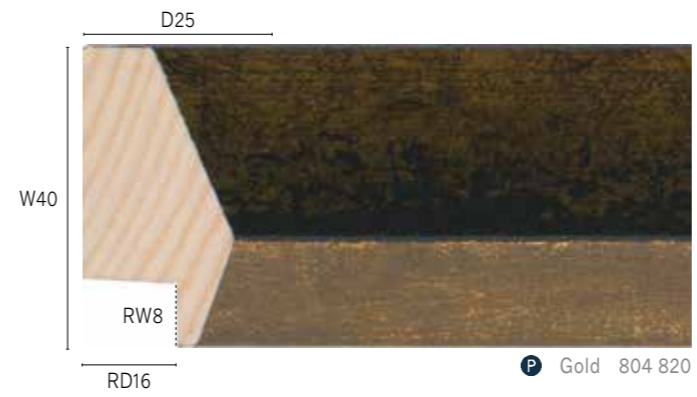
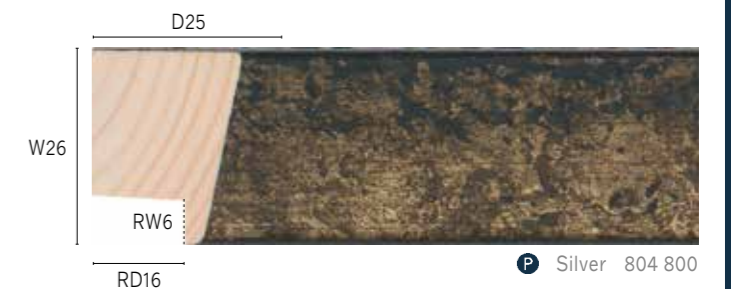
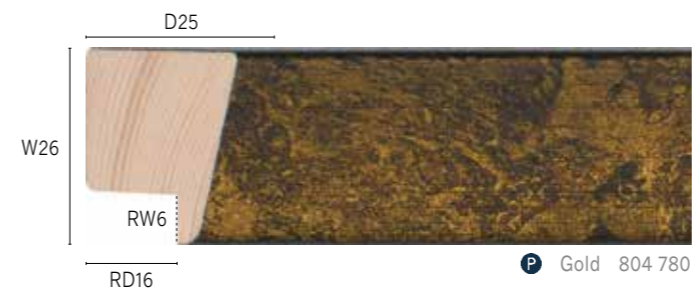



Brittany

The Brittany collection offers a sophisticated edge to the shabby chic trend with the depth of its chipped, coloured layers and natural finish achieved in the manufacturing process which includes hand finishing steps. Brittany's four authentic French coastal finishes create a well rounded palette of tones.

Moulding used

354 303

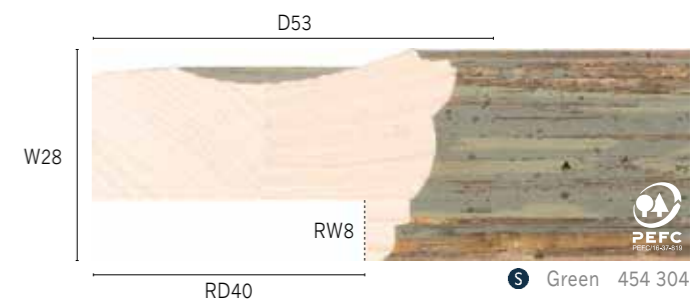
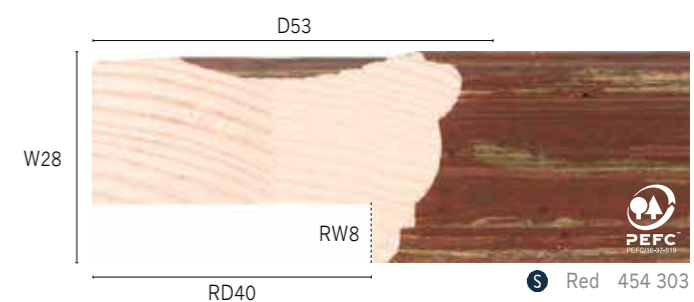
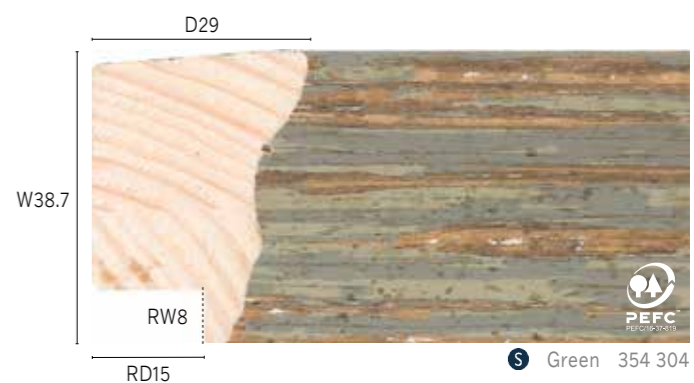
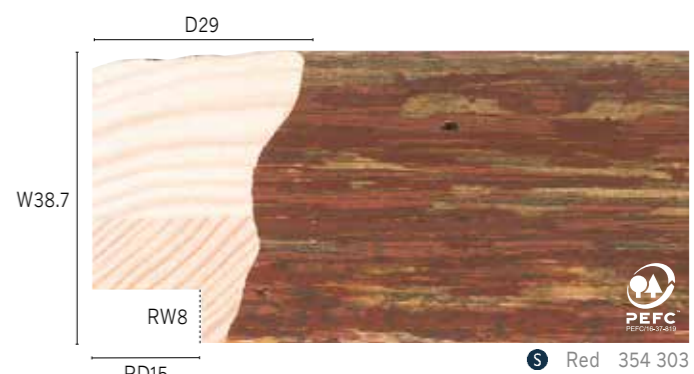
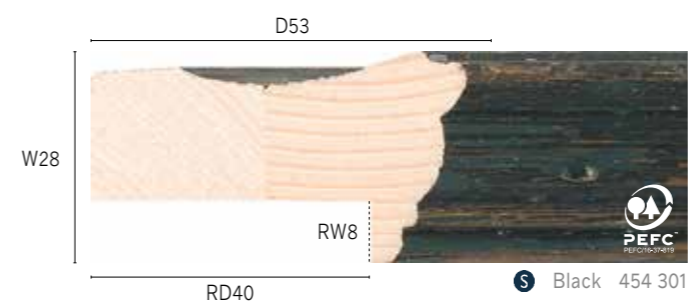
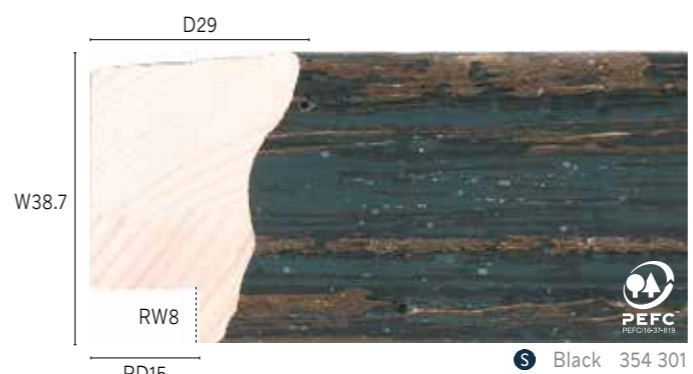
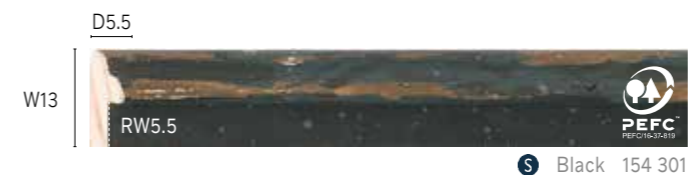



Black 554 301



Red 554 303



Ivory 554 302



Green 554 304

Canaletto

Canaletto is a beautiful range of four colours and will suit all types of artwork. Canaletto also has two matching mountslips that enhance the silver and pewter tones. Canaletto is particularly nice to use when framing a grouping for the wall. The finishes and profiles work beautifully together, whether you use one profile in several colours or one finish in each profile, the end result is spectacular!



Moulding used
645 305/115 302



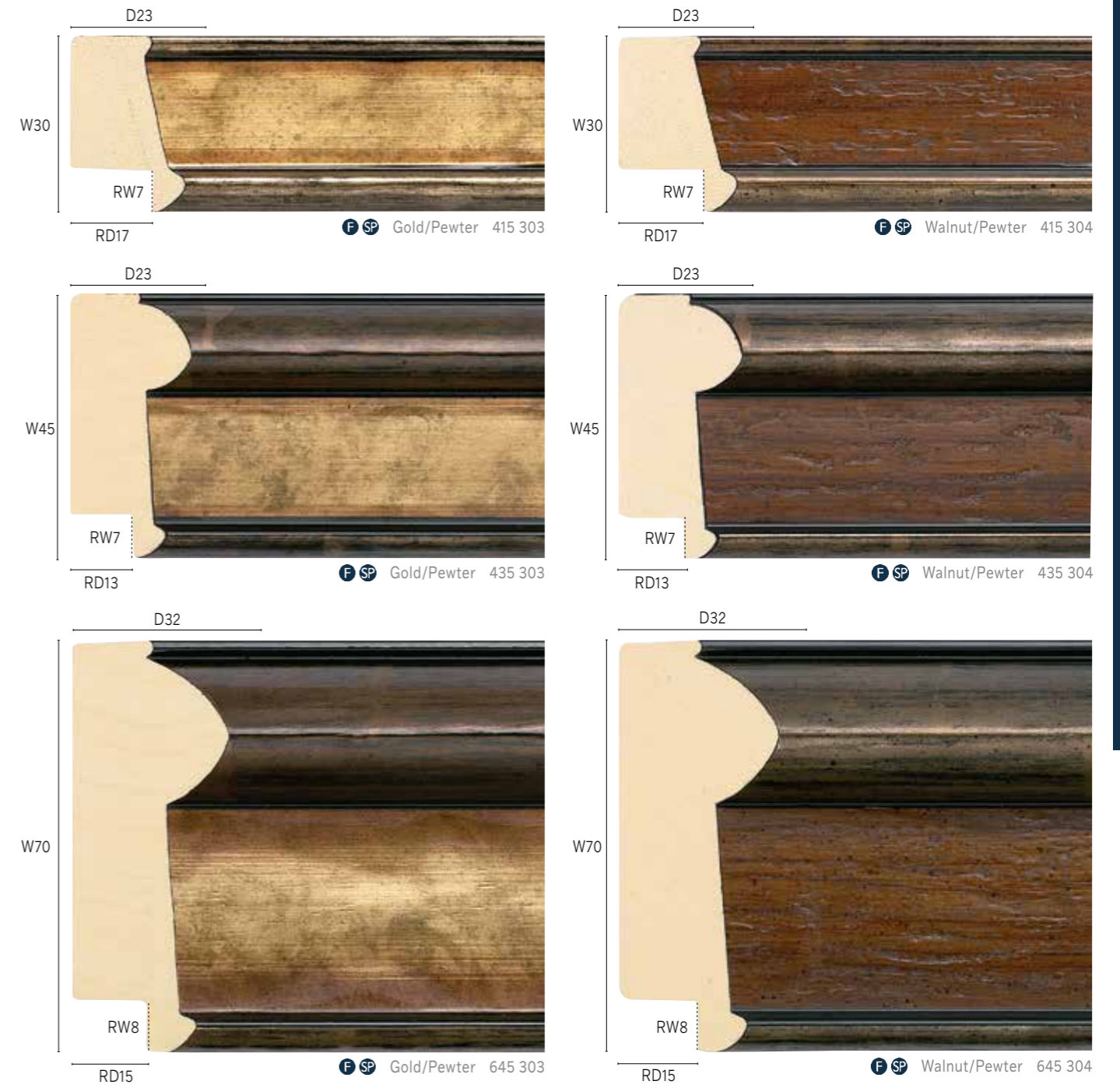

Carbon

Carbon is inspired by Yakisugi, the ancient technique of preserving wood through charring. It is great for modern, contemporary or traditional styles with a rich midnight finish. It has a heavy texture and a foil finish which present a robust, charred aesthetic.



Moulding used
583 100





Colosseum is very classical in terms of look and feel, it was inspired by the magnificence of Ancient Rome and the stepped design of the world's most famous amphitheatre.

Bold and brave, this range is hand-finished in oxide black with a chamfered gun-metal back edge. Colosseum will enhance simple monochrome artwork as well as paintings that feature strong use of colour.

These mouldings will sit beautifully with silver, cream, grey and black mountboards, for example, and will work stacked together as well as individually. The striking black finish of Colosseum, which is created by using patina and layered foils, will complement a vast breadth of interiors.

Colosseum

Moulding used
621 877







Confetti and Confetti Fillets

Confetti is a range of cubic profile mouldings. If you want to add a splash of colour to your framing then look no further. Not only does the range work beautifully together, they introduce a new element to mix with many other moulding collections and mountboards, when an extra touch of colour is needed.



Moulding used
140 645



 <p>D5 W11.8 RW5.5 P Yellow 115 632</p>	
 <p>D5 W11.8 RW5.5 P Mandarin 115 634</p>	 <p>D5 W11.8 RW5.5 P Grey 115 633</p>
 <p>D5 W11.8 RW5.5 P Blue 115 636</p>	 <p>D5 W11.8 RW5.5 P Rouge 115 635</p>
 <p>D5 W11.8 RW5.5 P Maroon 115 638</p>	 <p>D5 W11.8 RW5.5 P Green 115 637</p>
 <p>D5 W11.8 RW5.5 P Navy 115 640</p>	 <p>D5 W11.8 RW5.5 P Violet 115 639</p>
 <p>D5 W11.8 RW5.5 P Pale Green 115 642</p>	 <p>D5 W11.8 RW5.5 P Marine 115 641</p>
 <p>D5 W11.8 RW5.5 P Cream 115 644</p>	 <p>D5 W11.8 RW5.5 P Pale Blue 115 643</p>
 <p>D5 W11.8 RW5.5 P Sage Green 115 646</p>	 <p>D5 W11.8 RW5.5 P Pink 115 645</p>
 <p>D5 W11.8 RW5.5 P Turquoise 115 648</p>	 <p>D5 W11.8 RW5.5 P Fuschia 115 647</p>
 <p>D5 W11.8 RW5.5 P Emerald 115 650</p>	 <p>D5 W11.8 RW5.5 P Orange 115 649</p>
 <p>D5 W11.8 RW5.5 P Black 115 652</p>	 <p>D5 W11.8 RW5.5 P Gold 115 651</p>
 <p>D5 W11.8 RW5.5 P Silver 115 654</p>	 <p>D5 W11.8 RW5.5 P White 115 653</p>

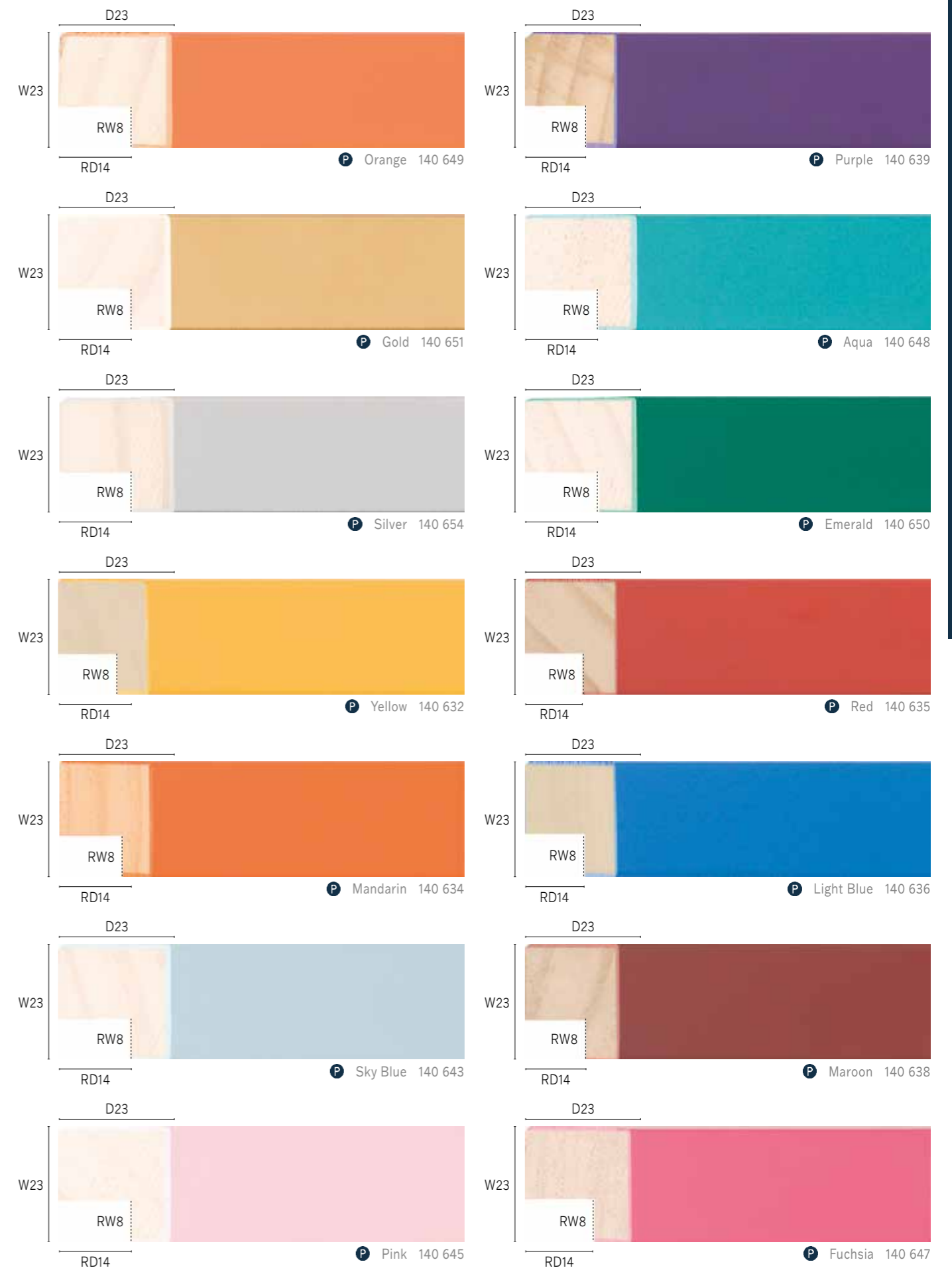

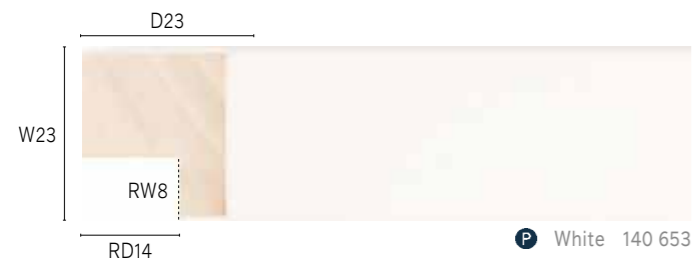

White 140 653

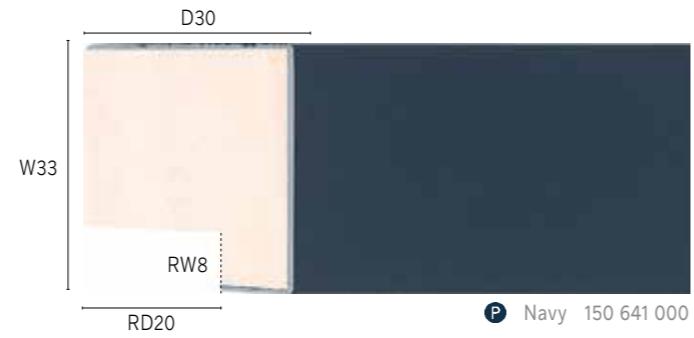

Navy 150 641 000



Grey 140 633

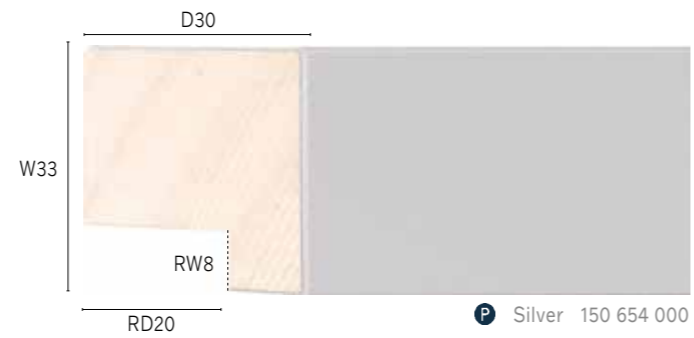

Silver 150 654 000



Blue 140 640



Gold 150 651 000



Navy 140 641



White 150 653 000

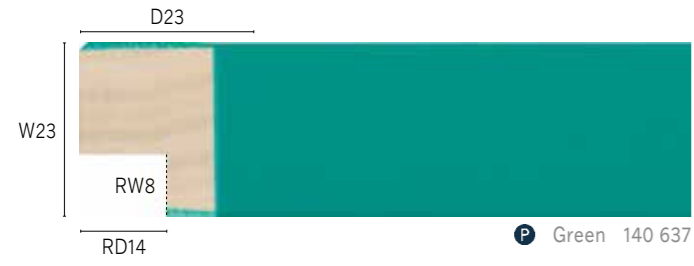

Green 140 637



Black 150 652 000



Black 140 652

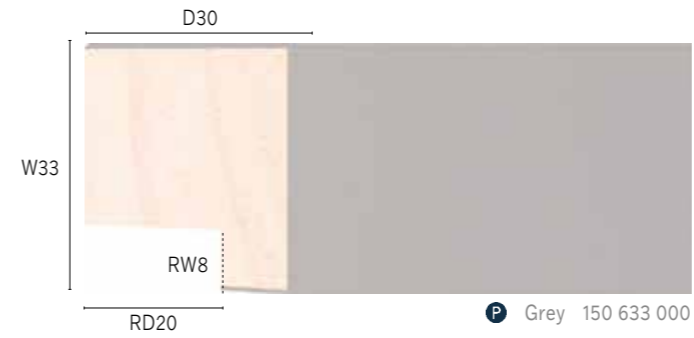

Grey 150 633 000



Yellow 150 632 000

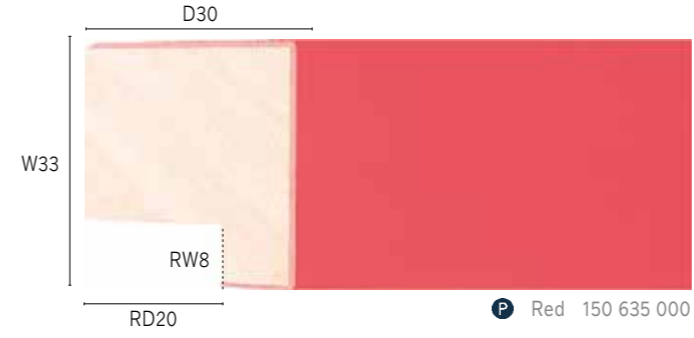

Red 150 635 000

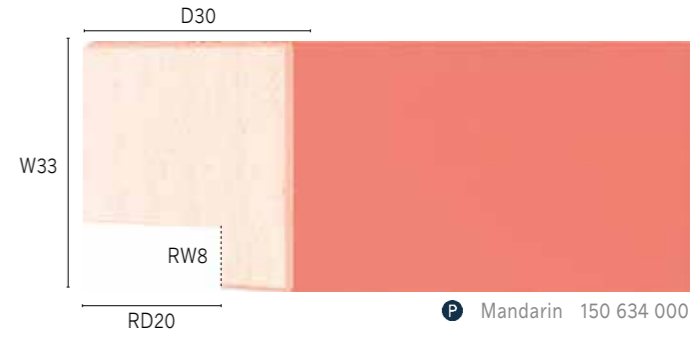

Mandarin 150 634 000



Green 150 637 000



Light Blue 150 636 000



Purple 150 639 000



Maroon 150 638 000

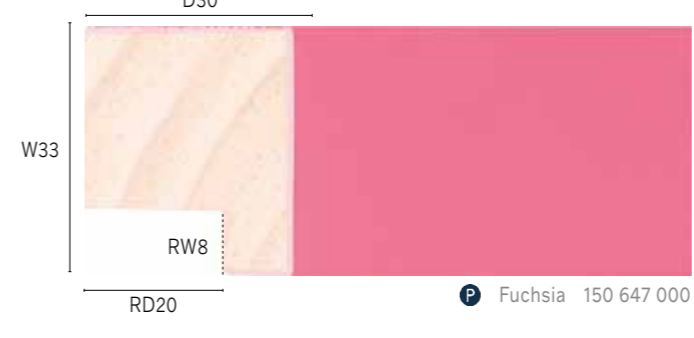

Fuchsia 150 647 000



Blue 150 640 000

Deco

Deco is an exclusive collection of hand finished traditional French style mouldings offering a superb craftsmanship and quality. Inspired by the grandeur and extravagance of bygone Europe, Deco is a classic range that will create a truly elegant look.

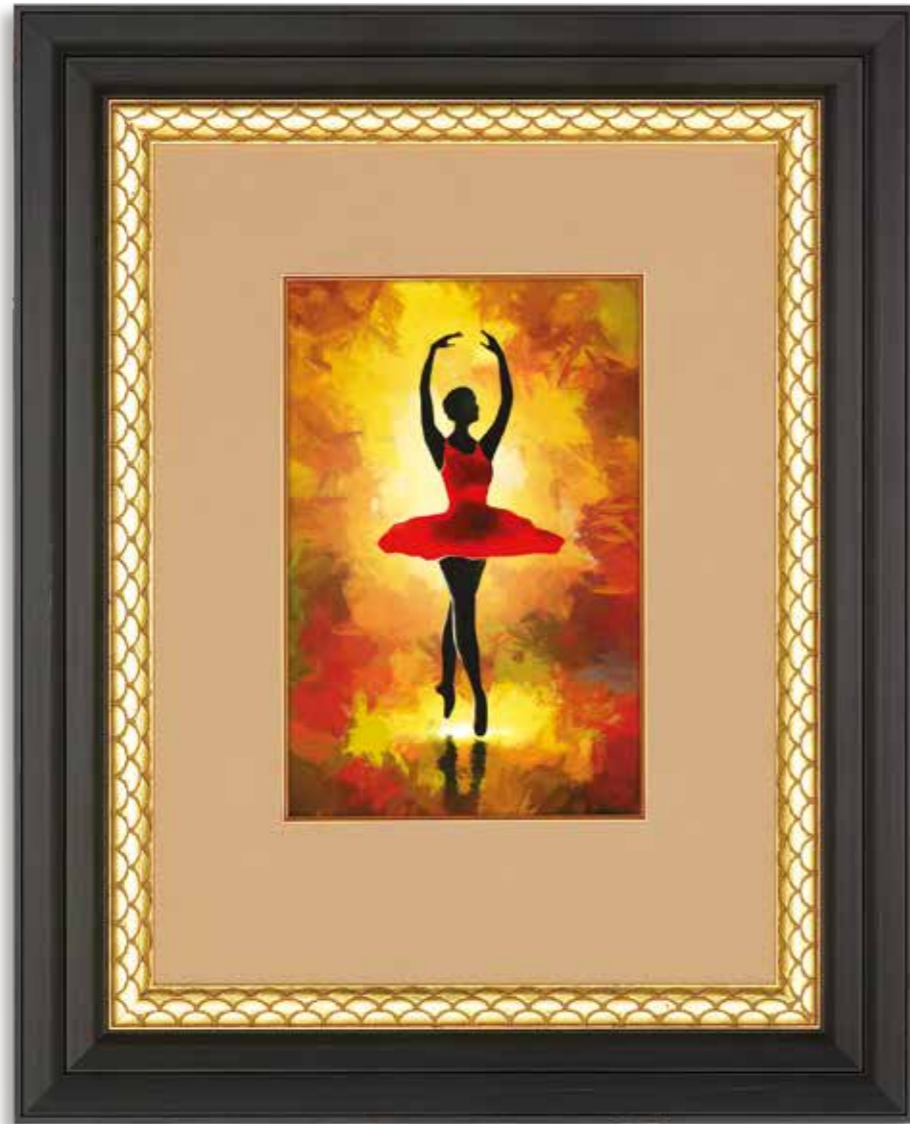

Moulding used
718 334

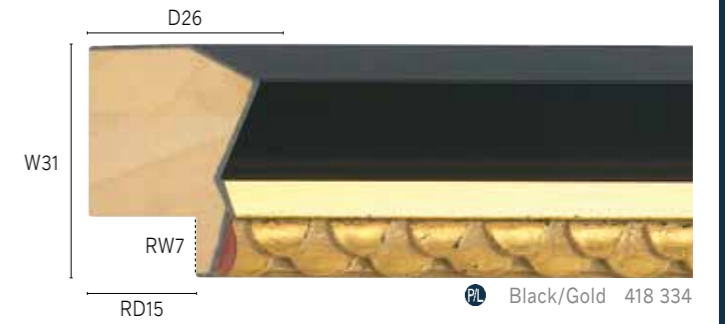
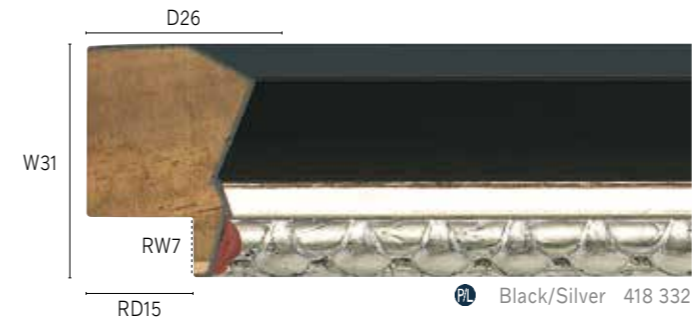



Dresden

Dresden's traditionally textured satin Black Umber finish is combined with matte silver detailing and applied to classic profiles reshaped in a modern manner. This unique finish has a mottled, waxy look – as if the frame has been repainted, re-stained and refinished over the years. A subtle, rich brown tone peaks through the darker, black topcoat, adding depth to a soft, timeworn, satin finish.



Moulding used
538 120

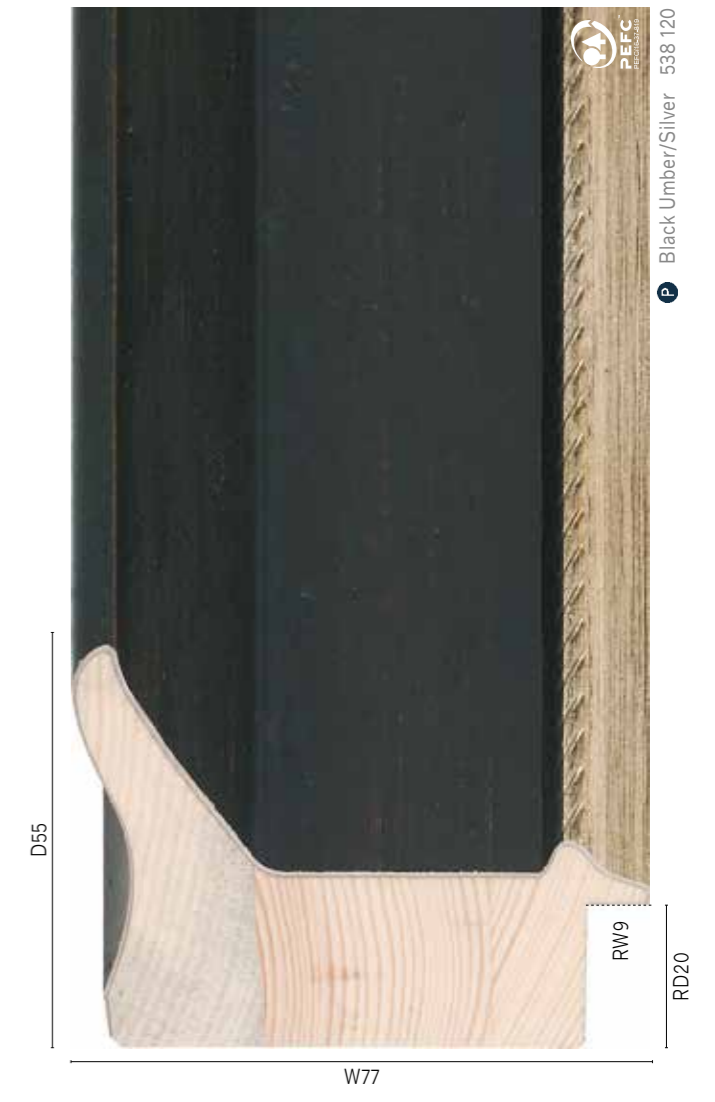
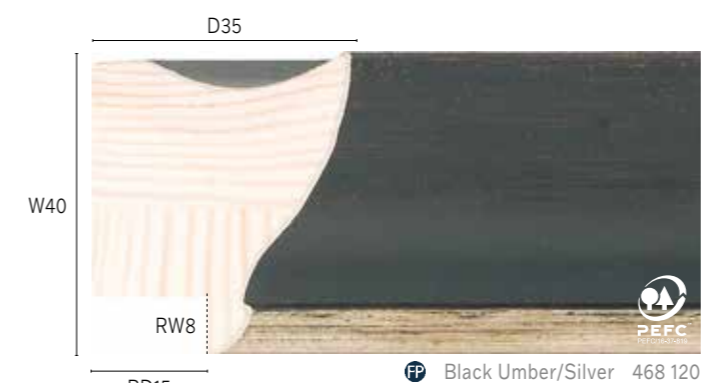
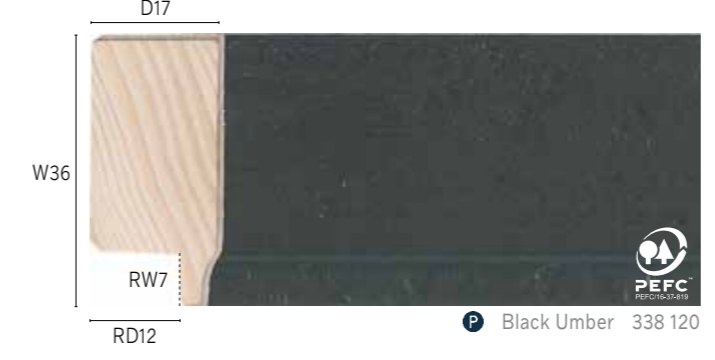

Eiffel



Le Tour Eiffel, named for its engineer Gustav Eiffel, is one of the most iconic and most visited structures in the world. Located in the heart of Paris on the Champ de Mars, it reminds visitors (and those dreaming of visiting) why Paris is called the City of Lights. The metallic finishes in the collection mimic the wrought iron used to construct all 984 feet, and the profile's texture is reminiscent of Eiffel's lattice pattern.



Moulding used
309 110

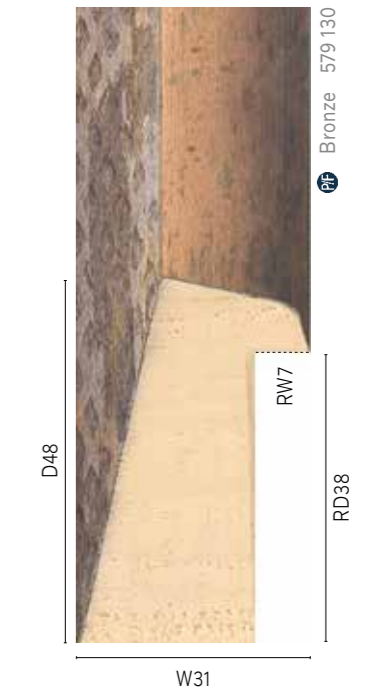
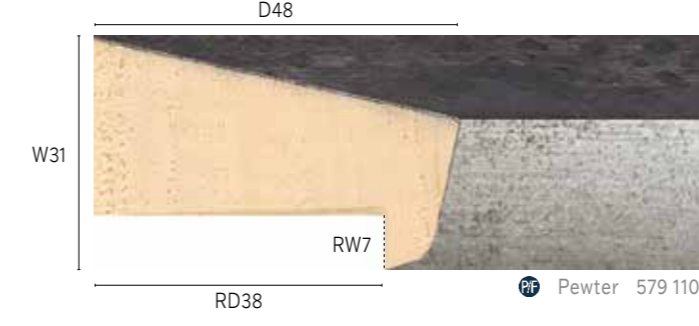
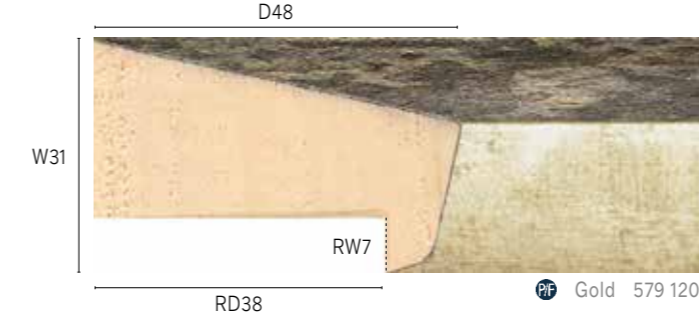
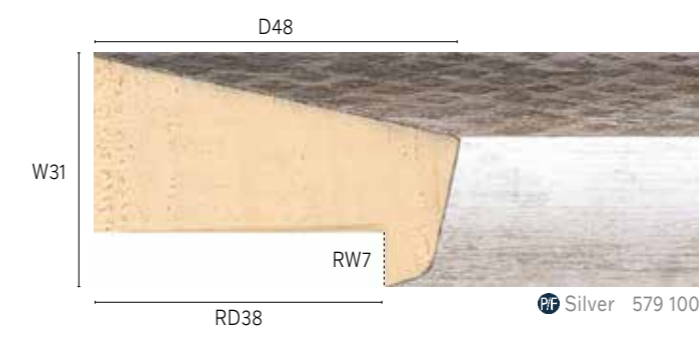

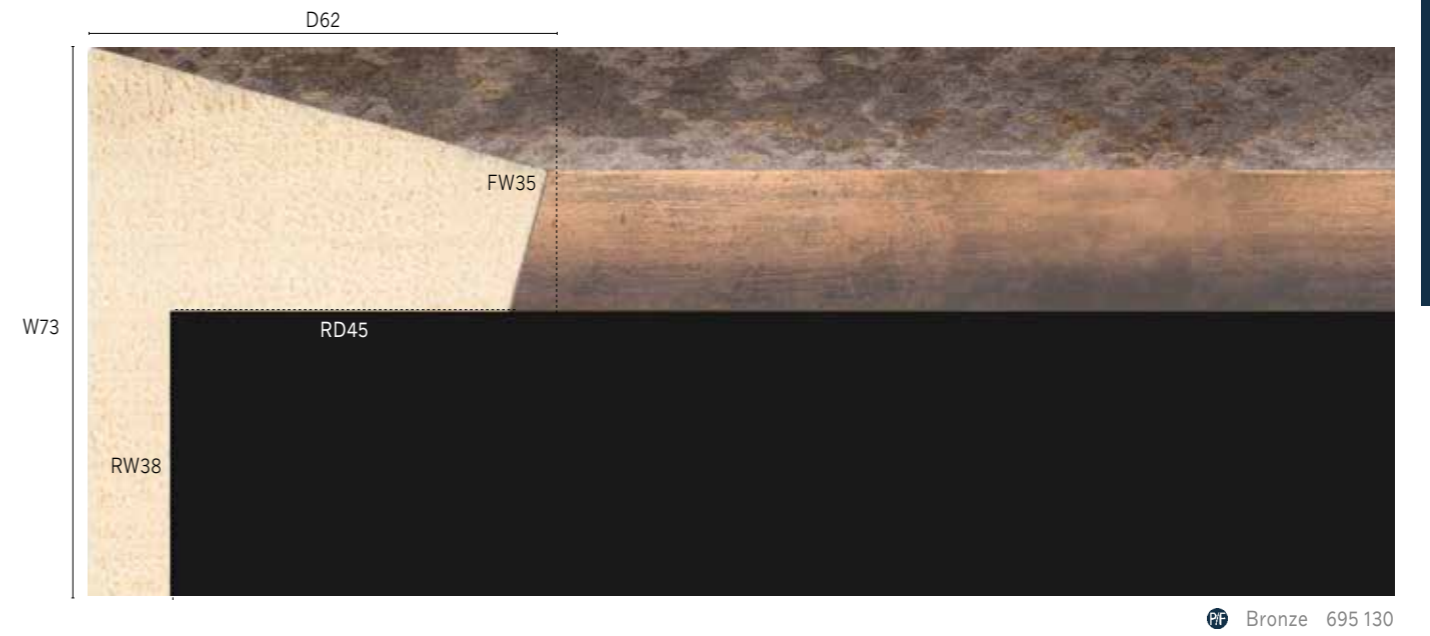
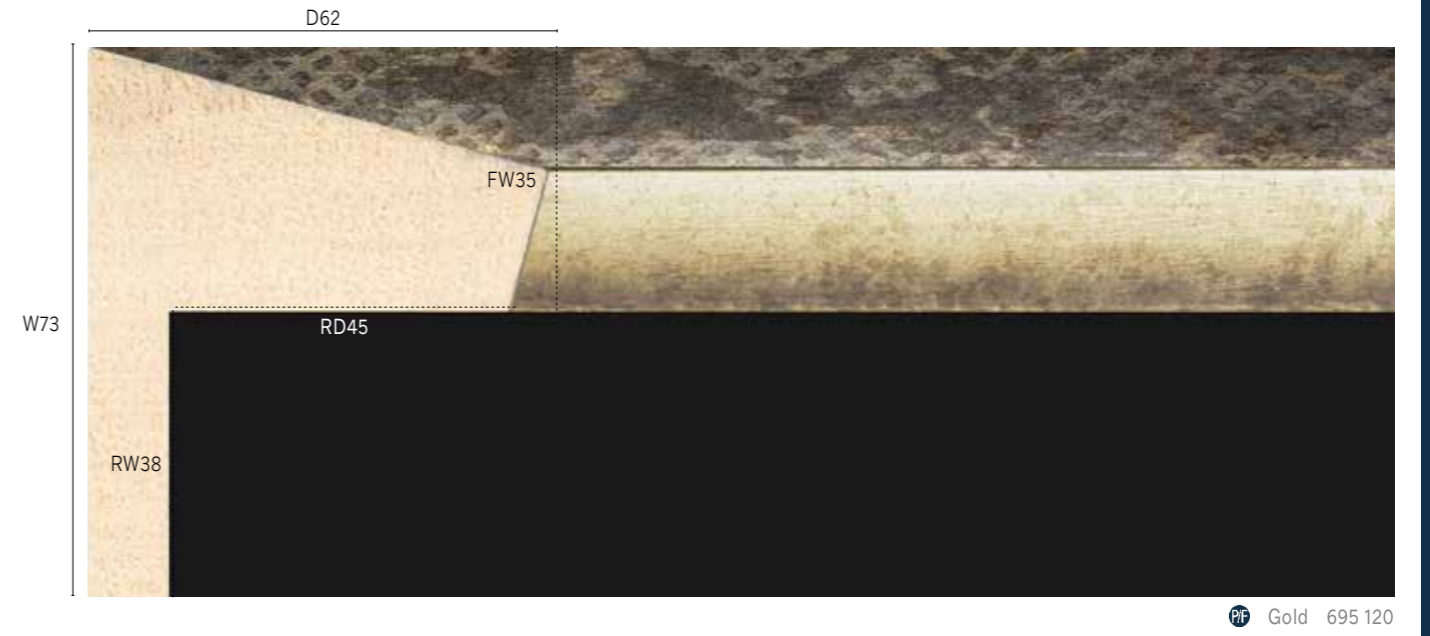
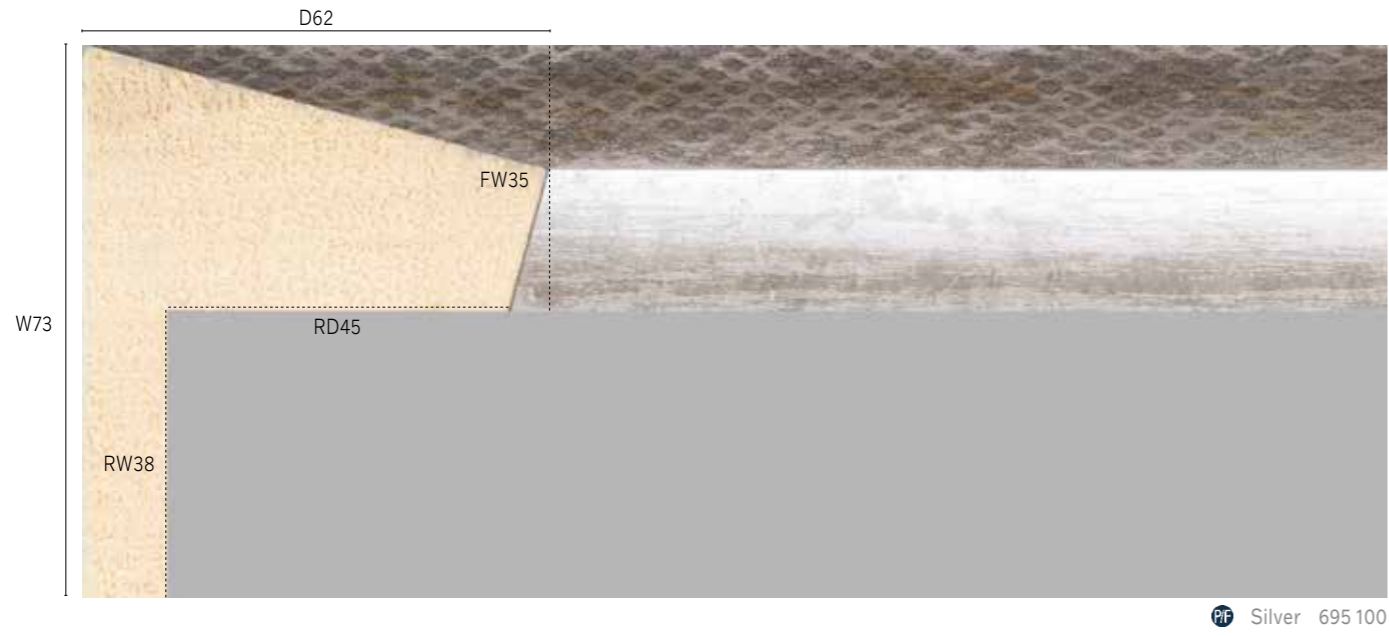

Fenice

The inspiration for this range came from the Fenice theatre built in Venice. The elegant finishes in gold, silver, black, ivory and burgundy are sophisticated colours that are distinctive, yet neutral for versatile framing.



Moulding used
364 500

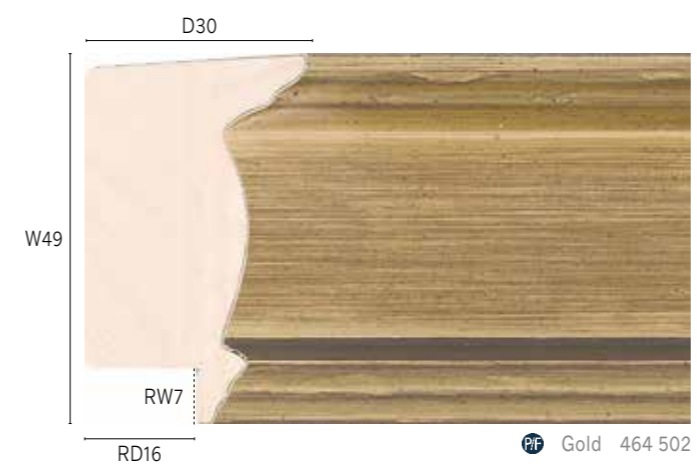
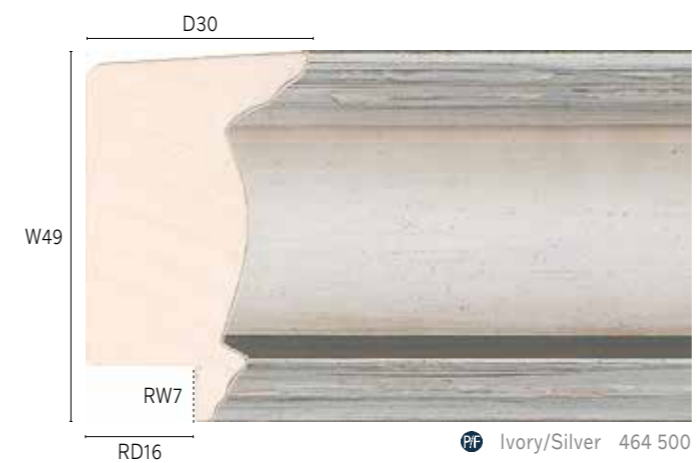
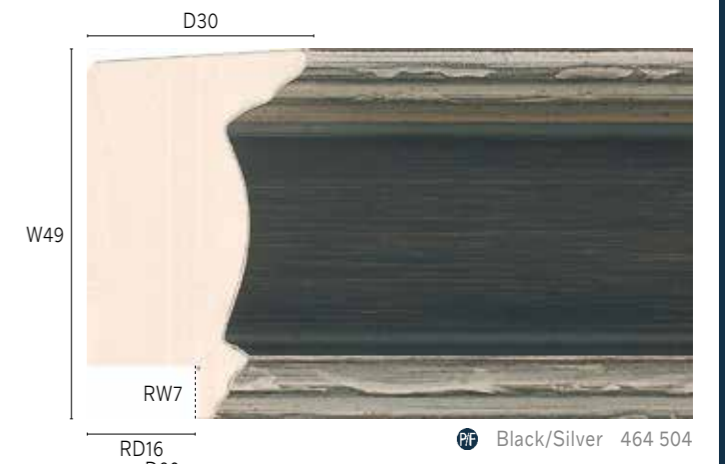
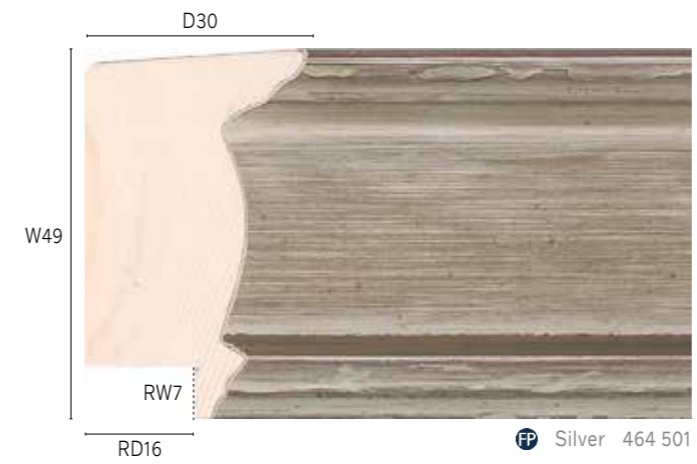

Ferrosa, Ferrosa II and Ferrosa Bronze

The look of forged, hammered metal adds character to this Ferrosa moulding. The versatile profile and metallic finish makes this frame appropriate for framing contemporary art or beautiful photography.



Moulding used
575 252



<p>Ⓕ Pewter 145 252</p>	<p>Ⓕ Iron 145 254</p>
<p>Ⓕ Pewter 235 252</p>	<p>Ⓕ Iron 235 254</p>
<p>Ⓕ Pewter 385 252</p>	<p>Ⓕ Iron 385 254</p>
<p>Ⓕ Pewter 395 252</p>	<p>Ⓕ Iron 395 254</p>
<p>Ⓕ Pewter 575 252</p>	<p>Ⓕ Iron 575 254</p>

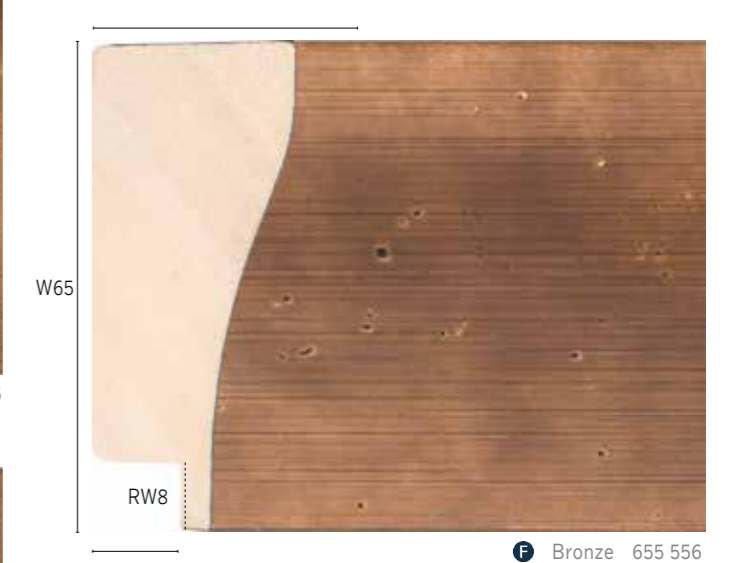
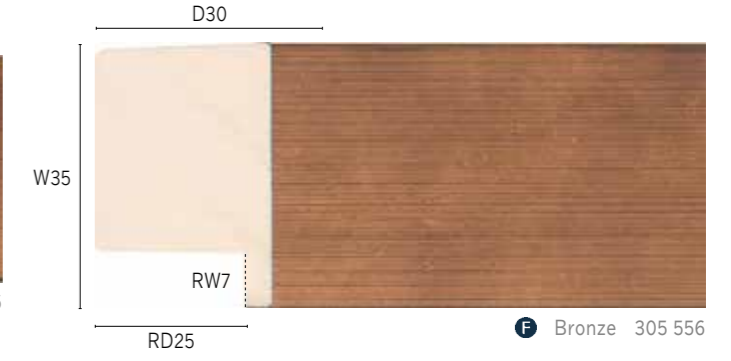
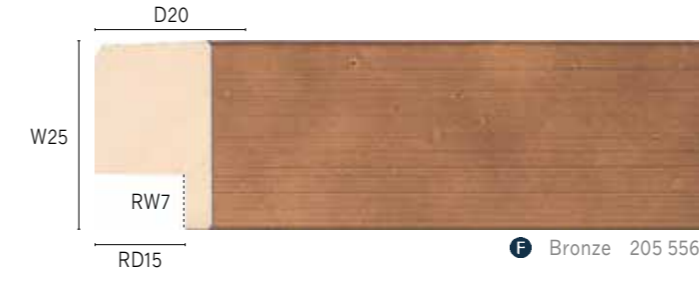
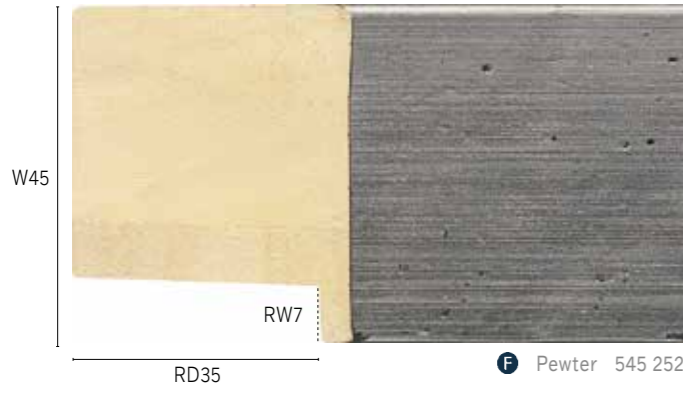
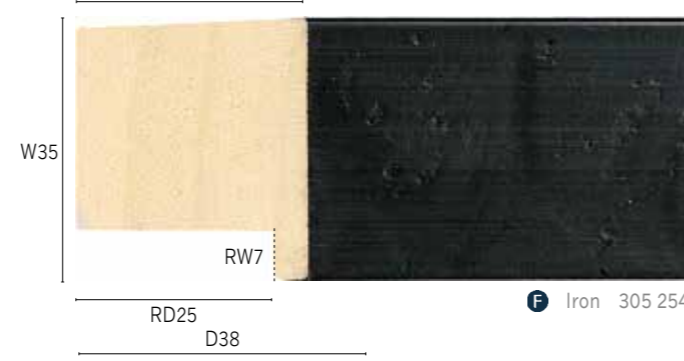
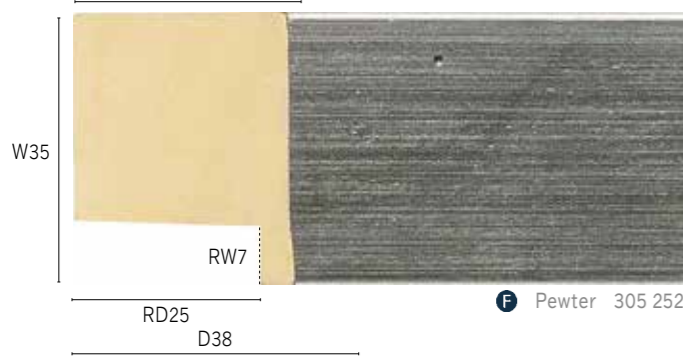
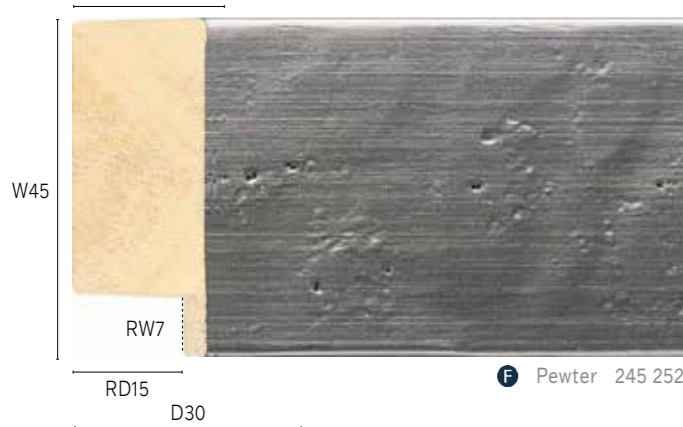
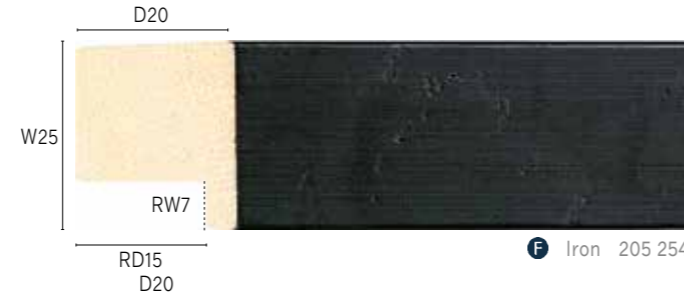
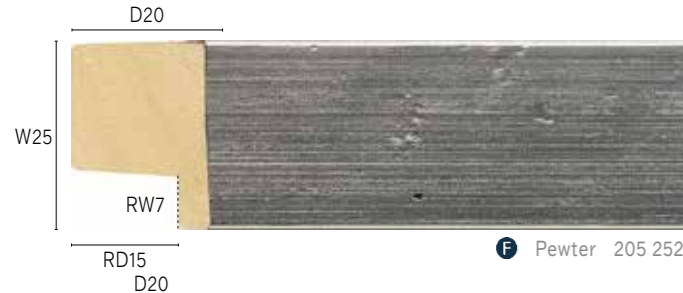
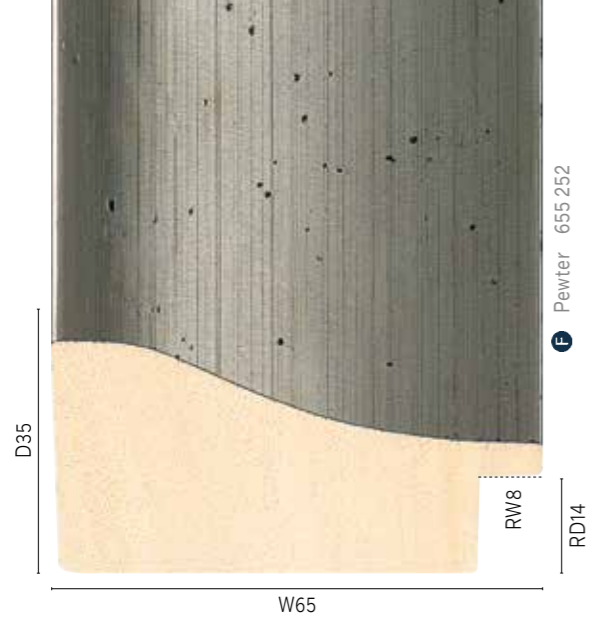

Florentina I and II

Florentina offers both warm and cool colours with metallic gold accents, creating a broad colour palette for endless opportunities in framing design. Each colour reacts in such a unique way with the oxidization process that Florentina creates a truly distinctive collection. Florentina's hues are an exceptional choice for use as a liner in creative stacking combinations with other Larson-Juhl mouldings.

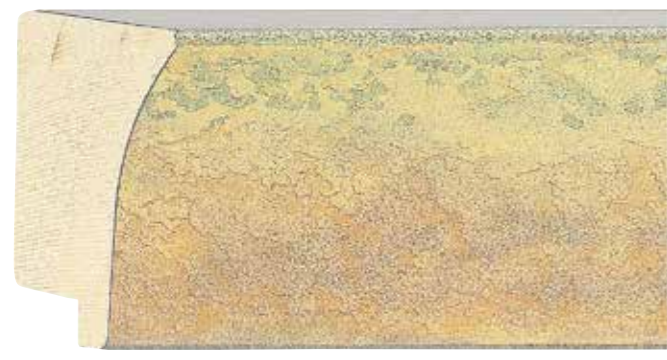

Moulding used
457 908

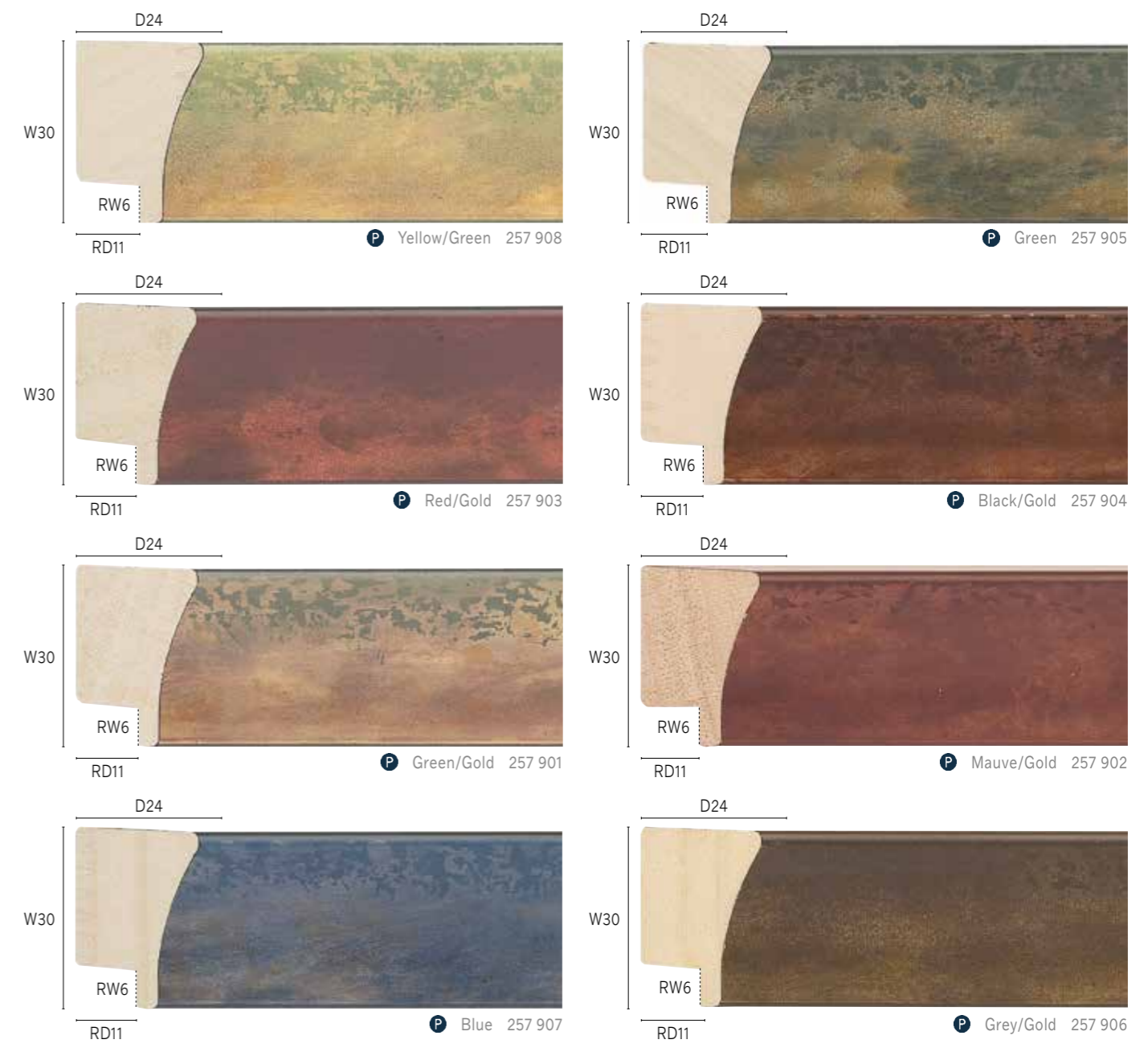

Foundry

Aged metallic finishes and contemporary urban styling have come together to create Foundry. Embodying the essence of raw materials in an industrial age, the Foundry range of transitional geometric profiles provide a timeless sophisticated look that is ideal for not only traditional oil paintings but also more modern black and white photography. Featuring matte patinas and worn metal edges they add a sense of age and a very definite sheen which perfectly contrast lustreless panels.

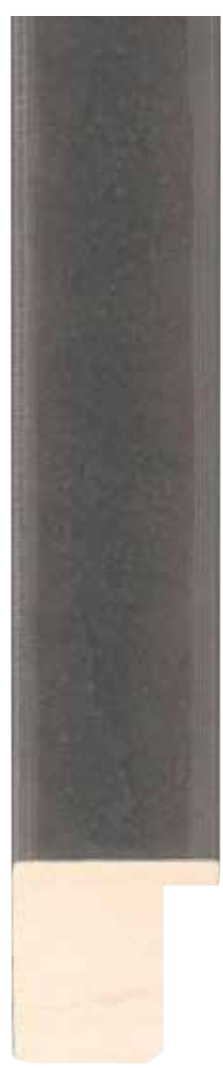
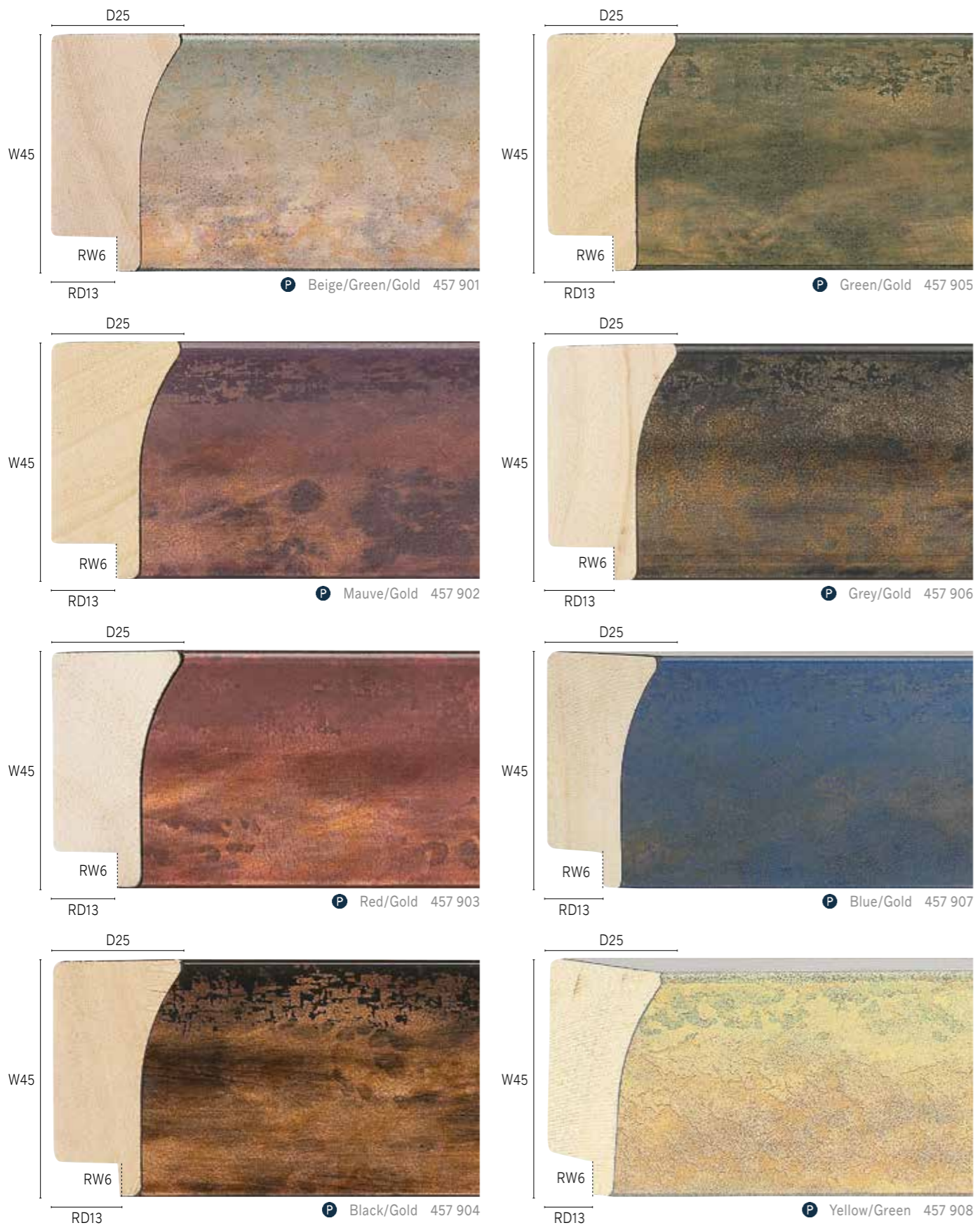

Moulding used
332 902

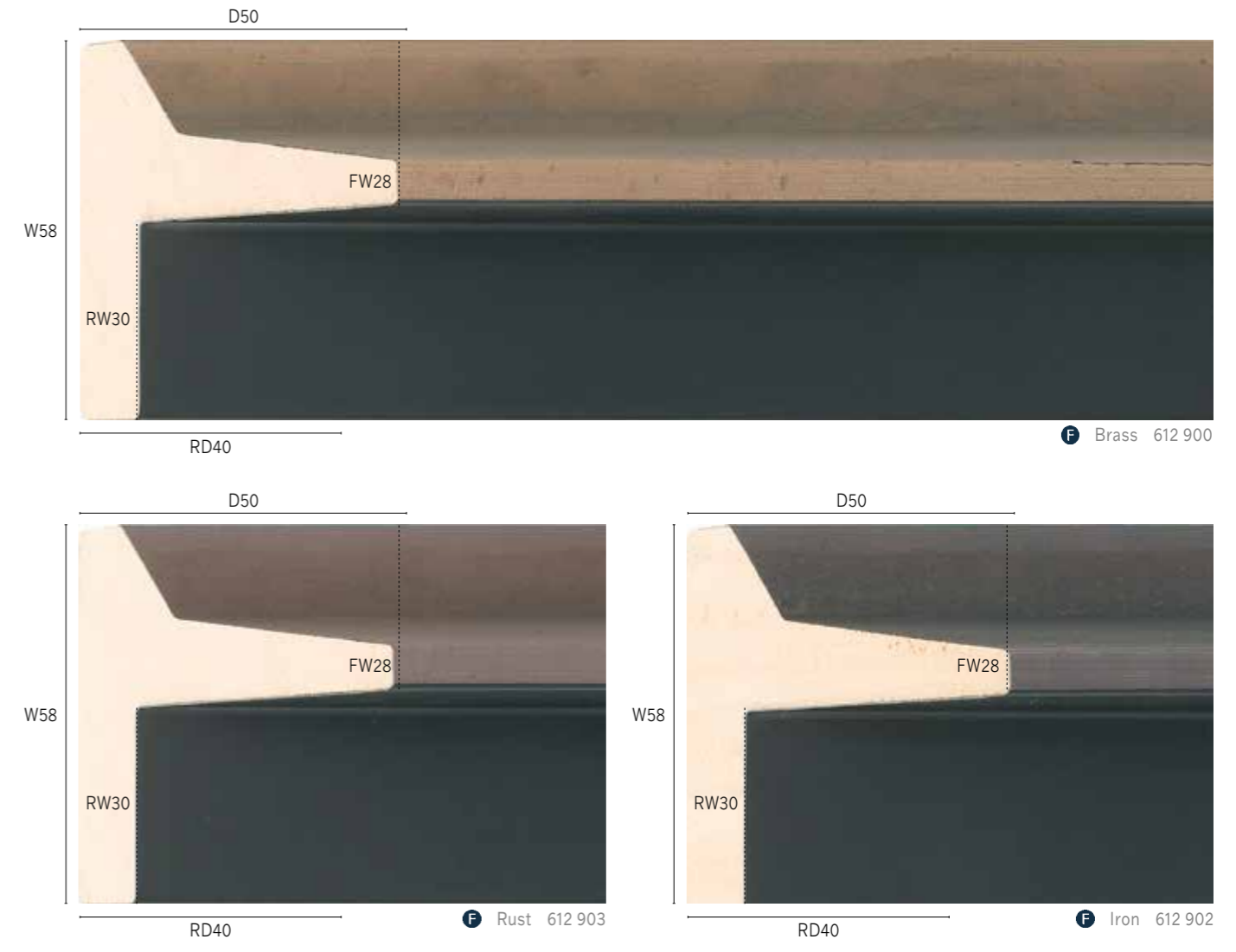
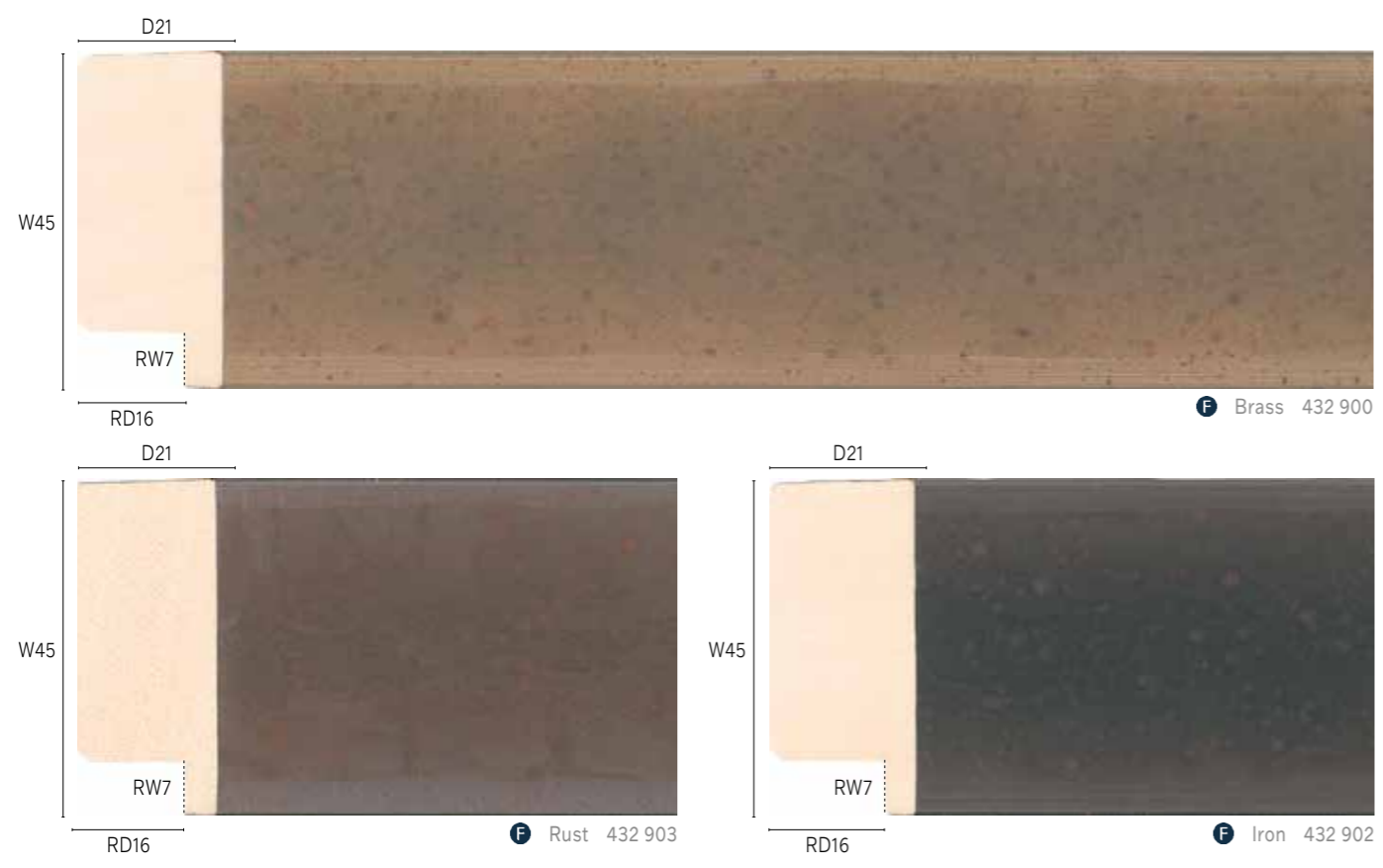

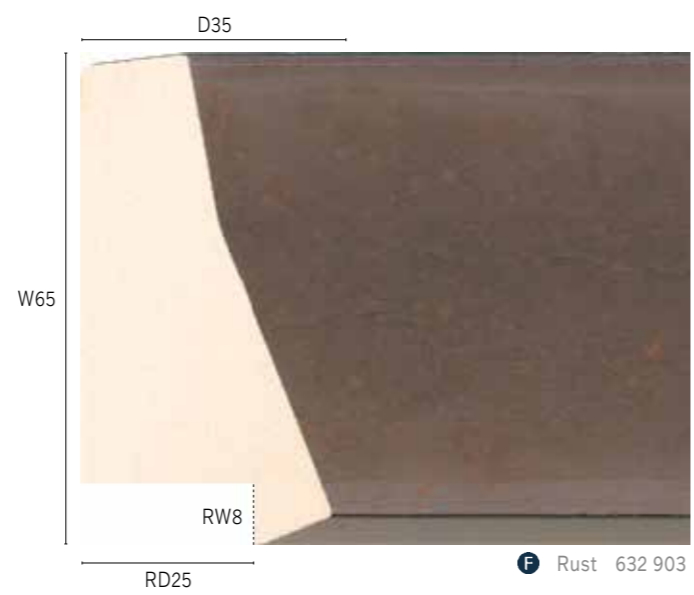
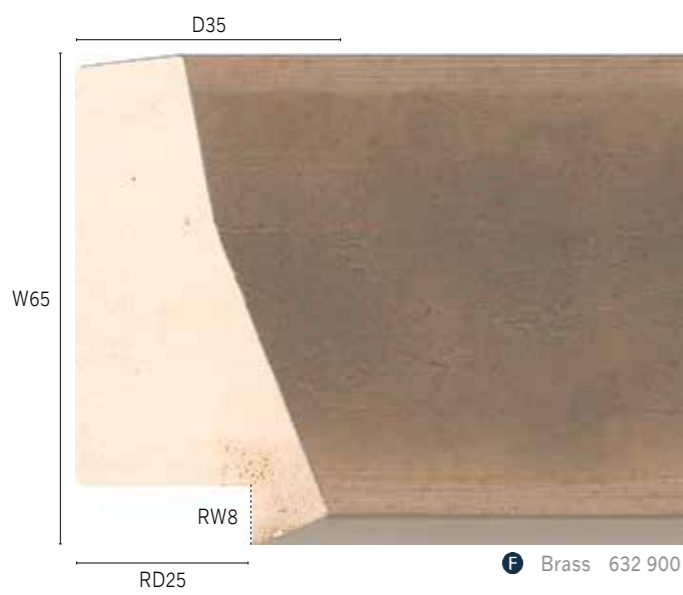

Gramercy I and II

The Gramercy Collection features a minimalist shape and a clean contemporary finish. Named after the region of Gramercy, one of New York City's most upscale neighbourhoods. It reflects modern style, practical and simple living.

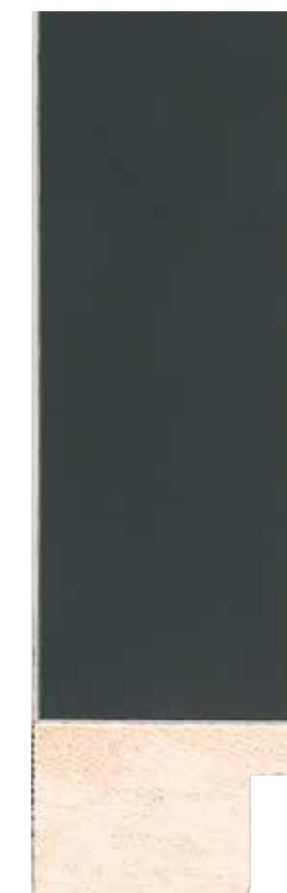

Moulding used
345 790

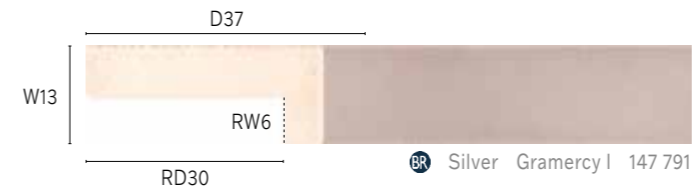
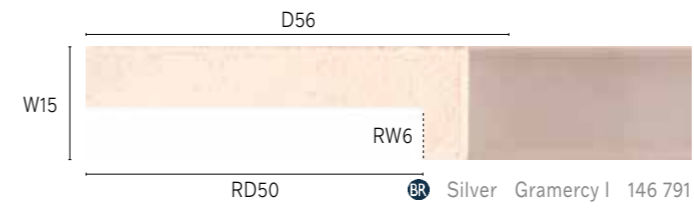
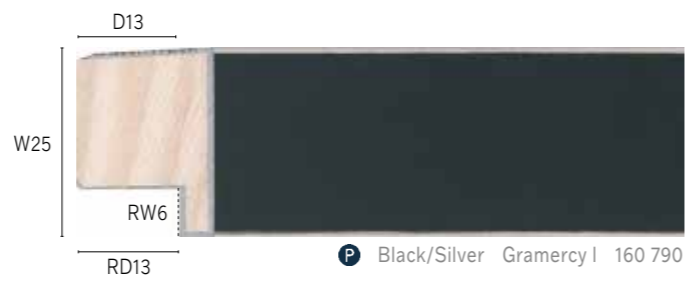
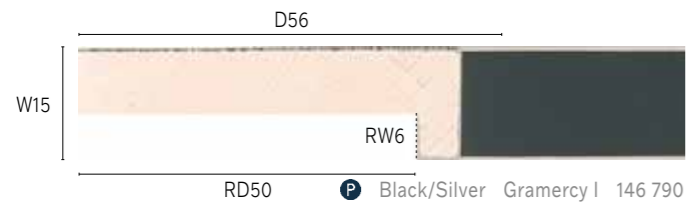

Imperial

Our Imperial collection with its fine detail and classic finish, is inspired by the grace and elegance of 17th century France. From the renaissance to the revolution, the cultural and artistic style is captured in this collection.



Moulding used
373 IG

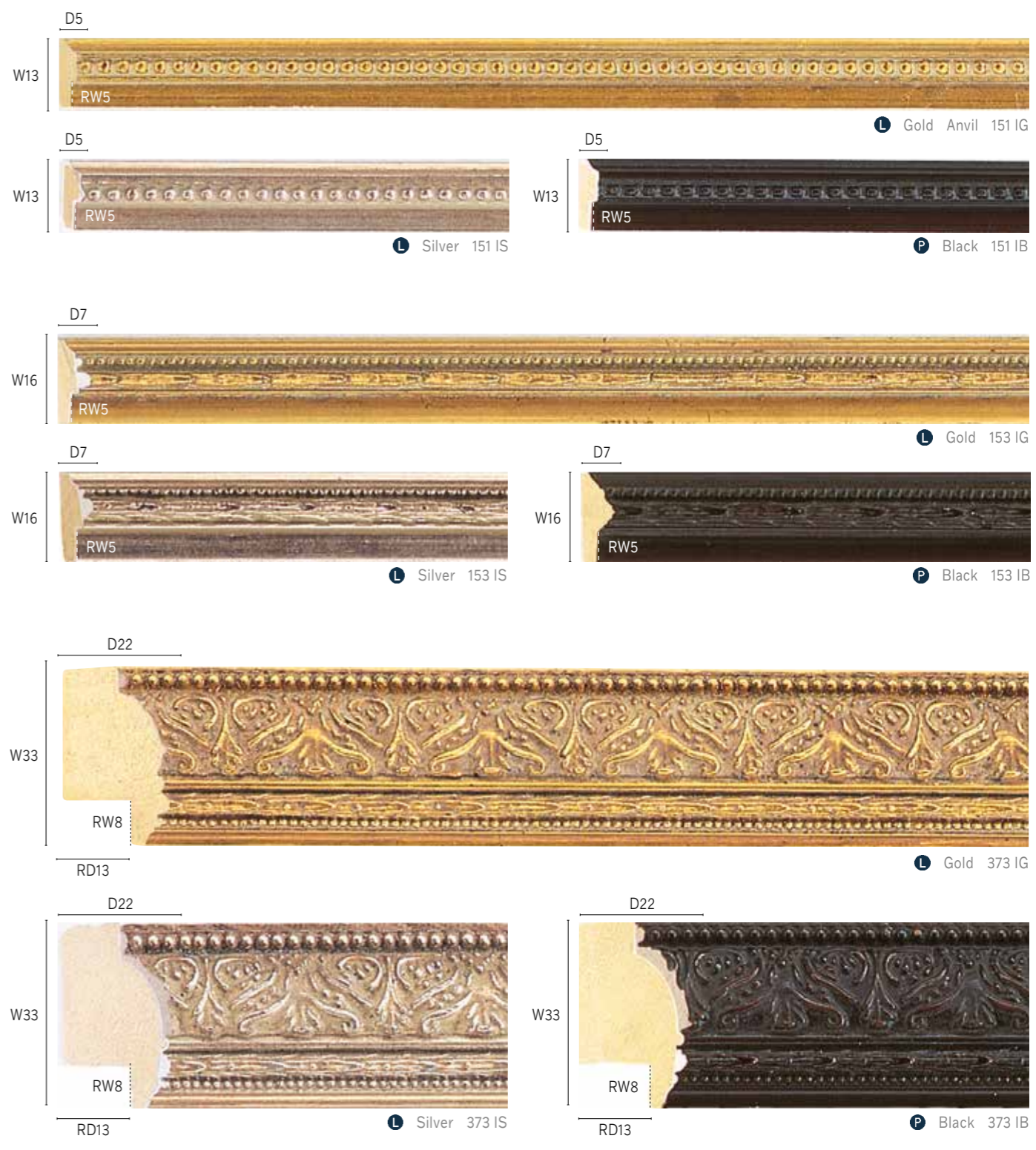





Intermezzo

Our Intermezzo range features a transitional profile that looks good in formal, traditional, and contemporary spaces.

Moulding used
771 560

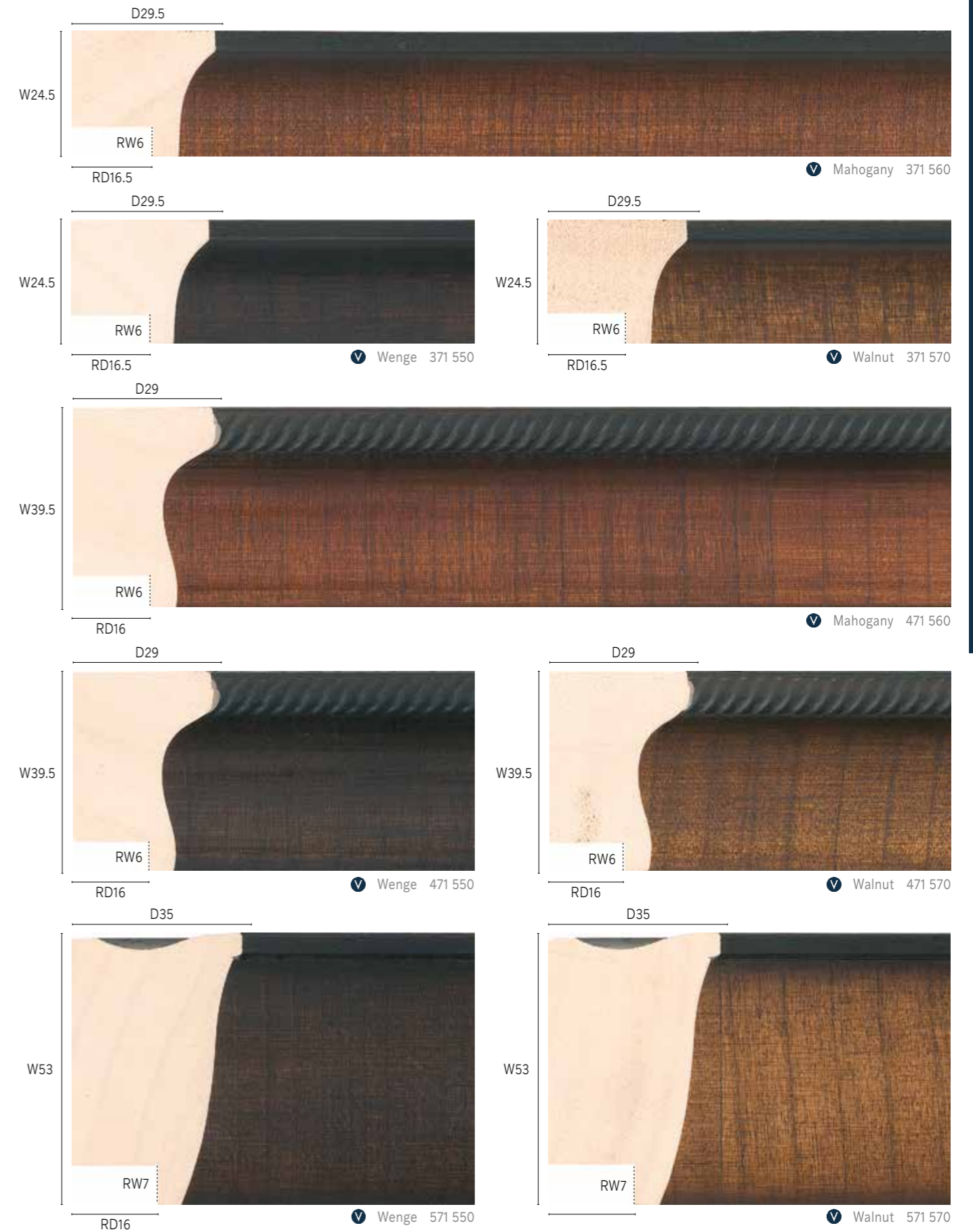



Komodo

Komodo has an authentic finishing technique featuring hand brushed textural lacquer with a high lustre lacquered finish. It features hand rubbed edges that reveal accents of black and brown. Komodo has contemporary clean modern profiles which are ideal for all types of artwork including photographic and oriental style.



Moulding used

314 240



Komodo II

Responding to Asian home decor both colours featured in the Komodo II collection are historical and often found in antique and modern ceramics and asian artwork.

Celadon is ideal for interiors which are featuring blues, teals and greens and the Ivory offers a soft yet complex complement to cream and white interiors

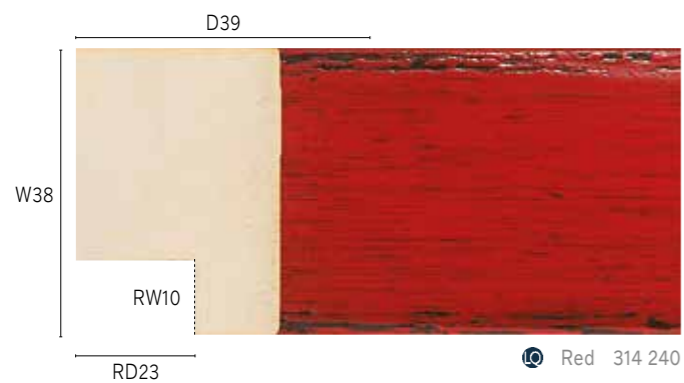
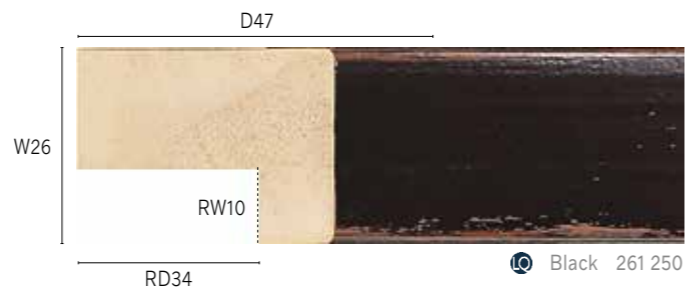
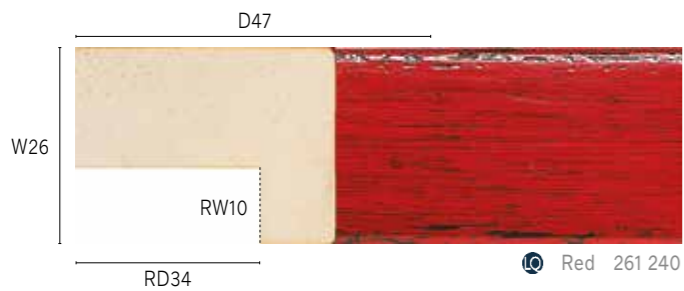
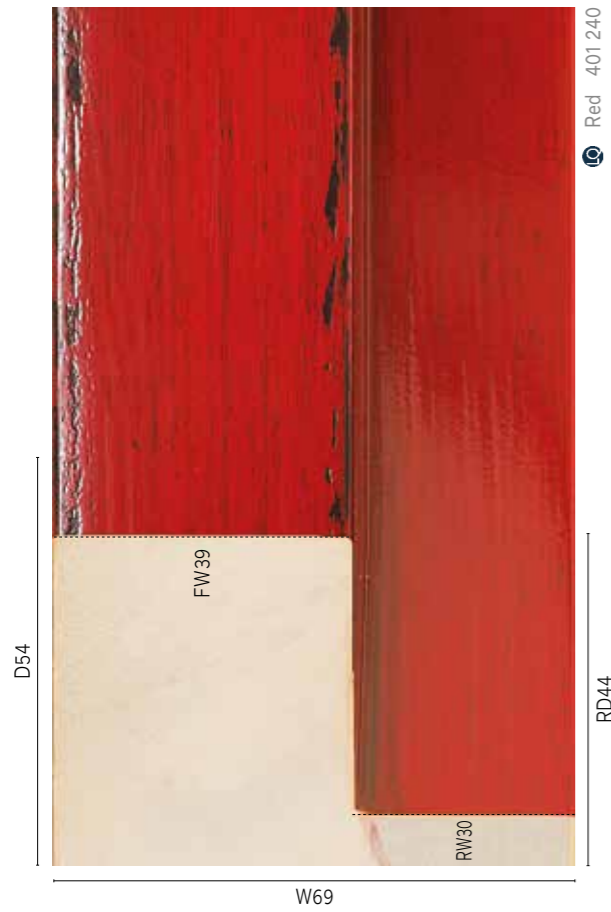

Moulding used
241 270

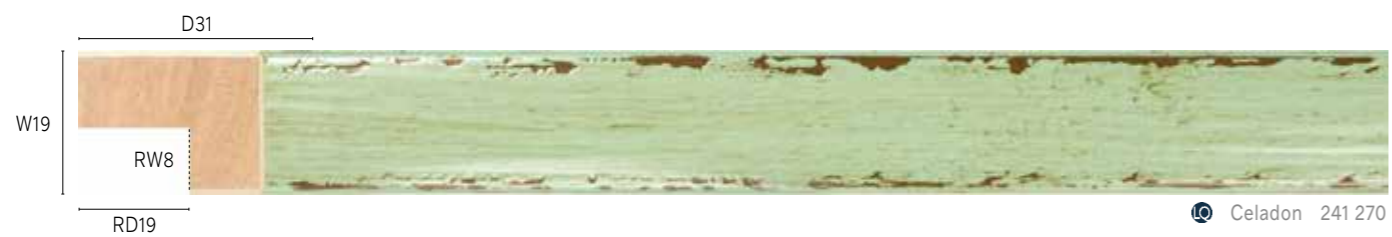

Lancaster

The natural worn-wood simplicity of Larson-Juhl's rustic-inspired Lancaster collection, offers framers a way to achieve a real understated style for any framing project.



Moulding used

359 250



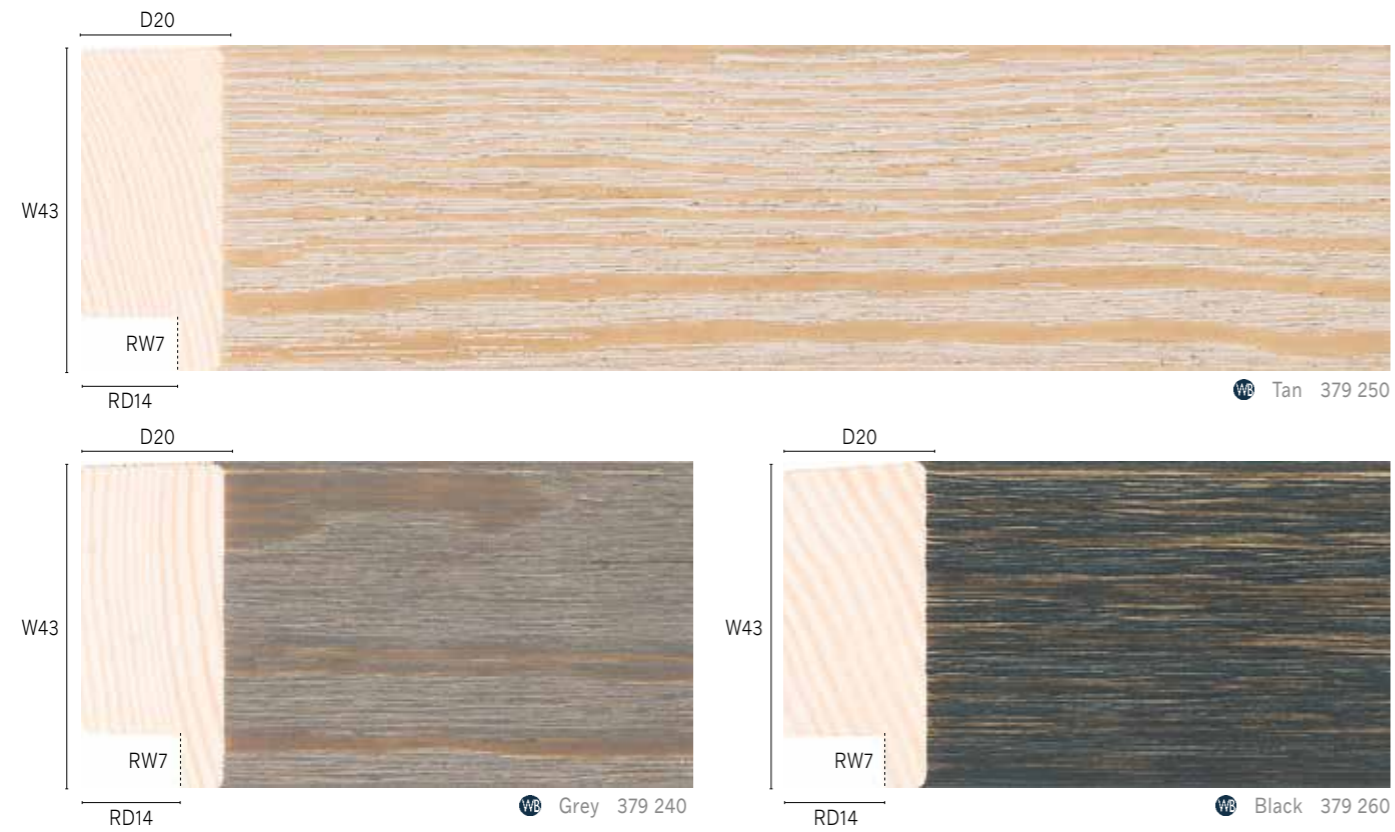
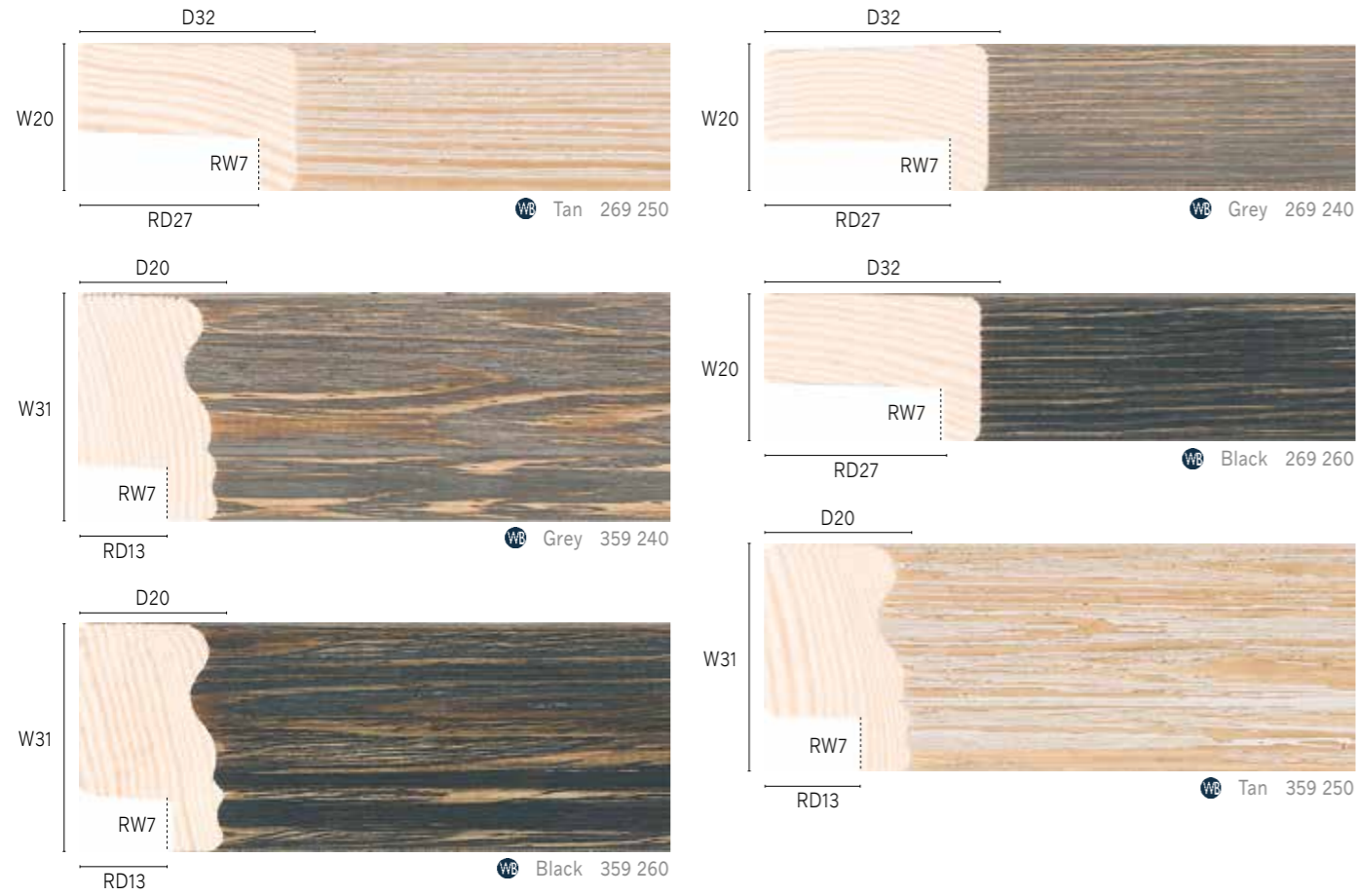

Lille

From cool silver to deep pewter, refined gold and ageless bronze, Lille has a reflective finish with the look of wire mesh on the two larger profiles. It is a contemporary design combining industrial chic with classic shapes.



Moulding used
580 470

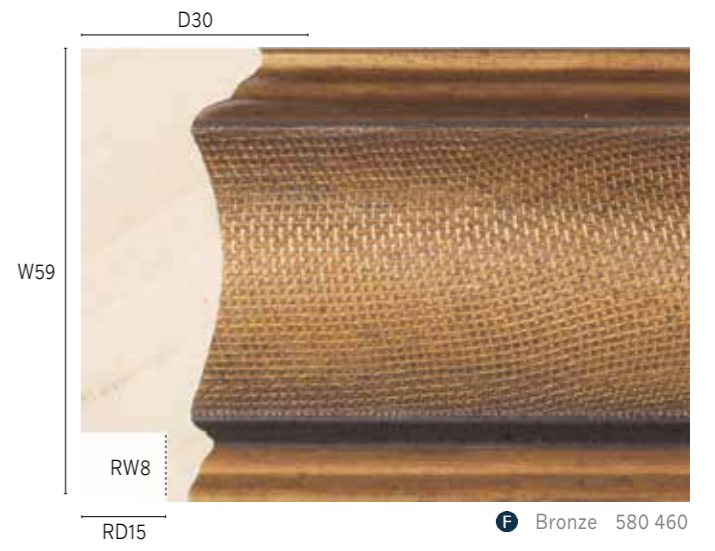
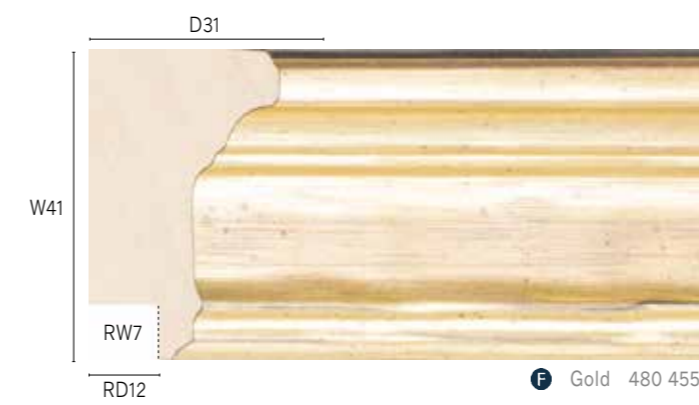

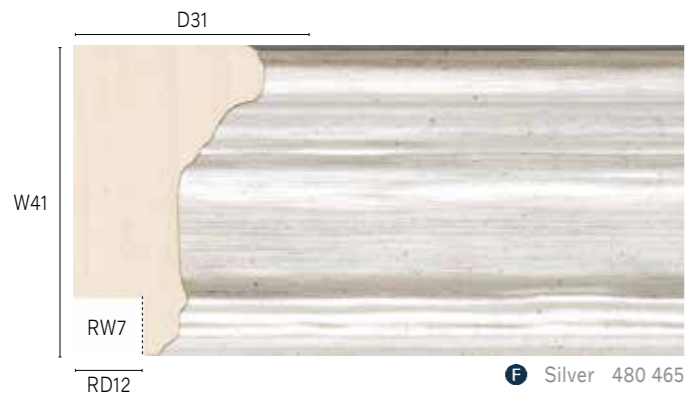

Lucerne



Lucerne has the look of real silver mixed with textured panels of colours, which is reminiscent of Switzerland's Lake Lucerne. All four finishes of Lucerne: gold, green, red, and black, fit well with today's interiors, furniture and accessories.

Moulding used
850 792

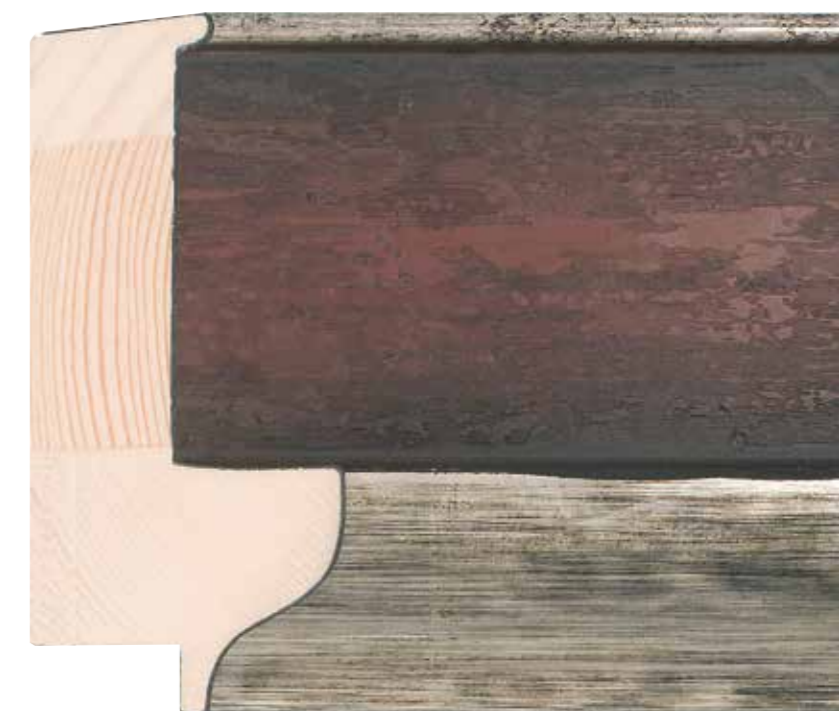

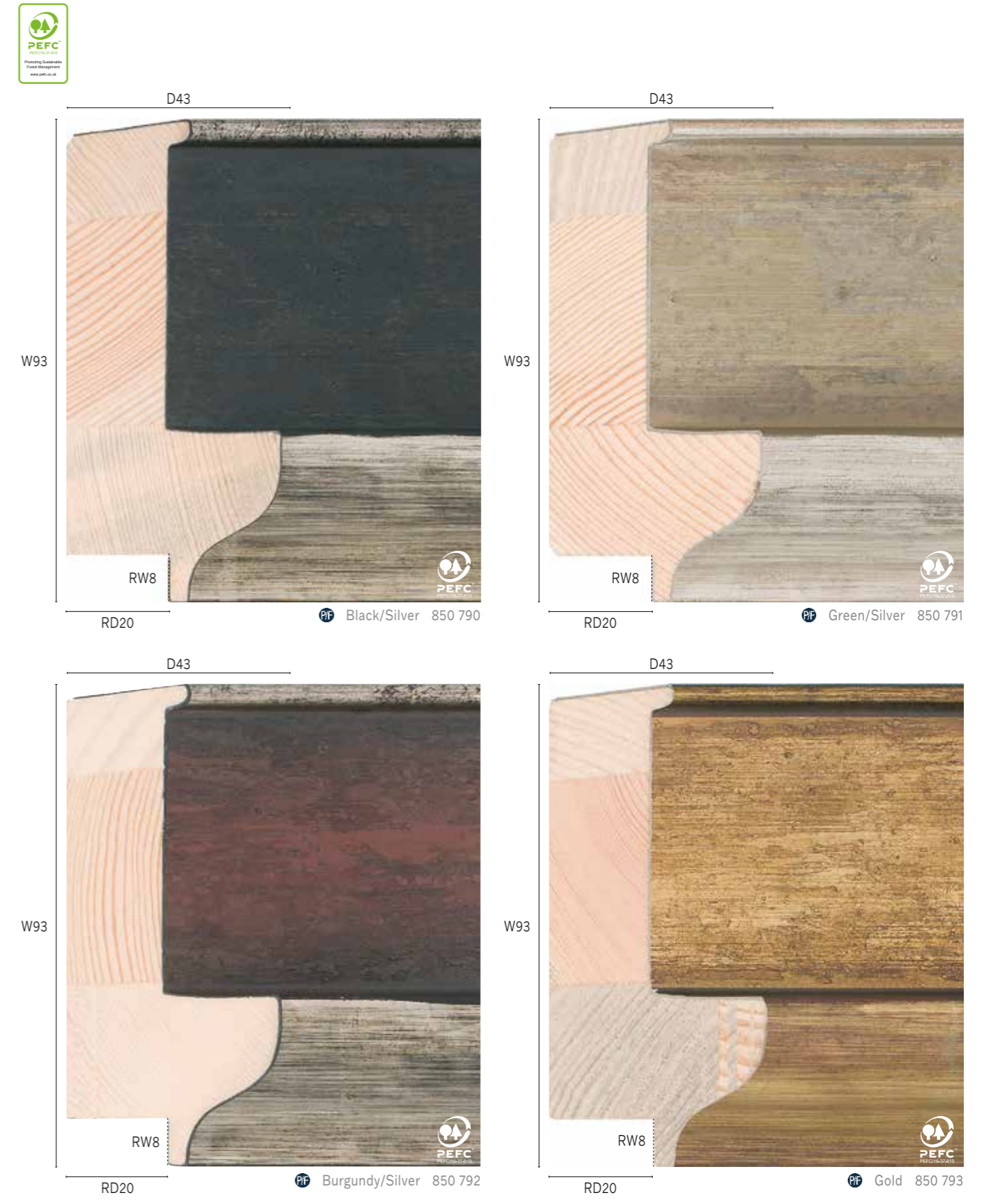
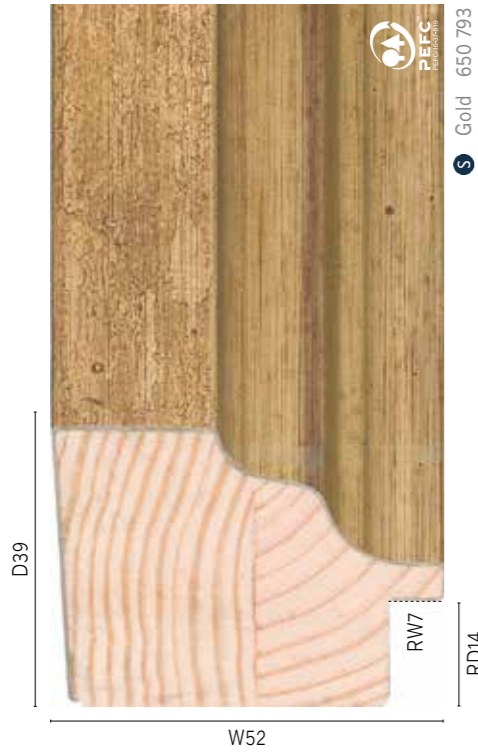
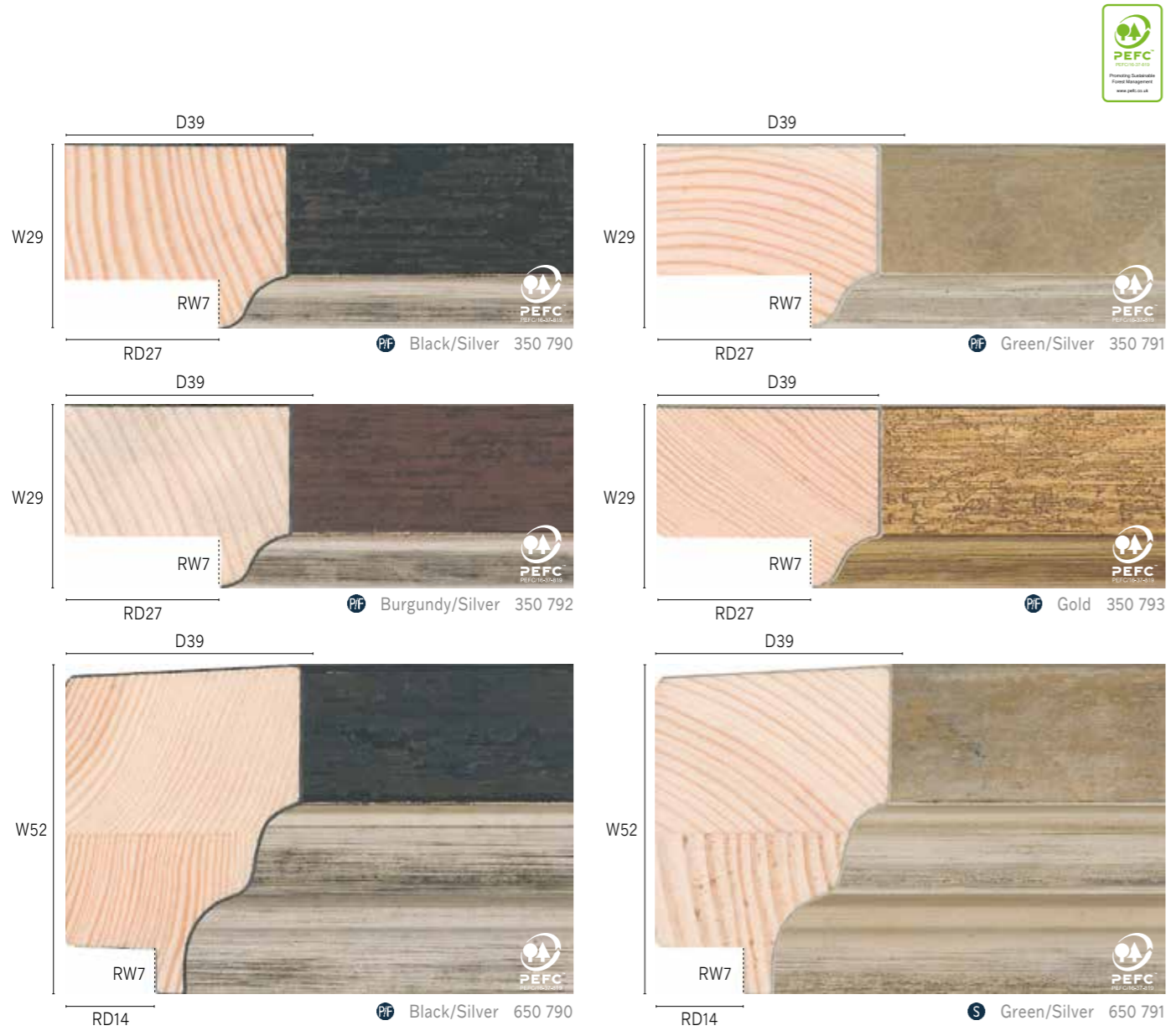



Malta and Malta Small

A metallic finish suited to delicate cross-stitches, tapestries and soft artwork. The champagne finish is elegant, whilst the silver is mixed with a range of pallet options to bring depth to the collection.



Moulding used
442 607

D25		PEFC F Champagne 312 604
W19 RD13		
D25		PEFC F Silver/Ochre 312 608
W19 RD13		
D25		PEFC F Silver/Orange 312 605
W19 RD13		
D25		PEFC F Silver/Red 312 609
W19 RD13		
D25		PEFC F Silver/Black 312 606
W19 RD13		
D25		PEFC F Silver/Blue 312 607
W19 RD13		

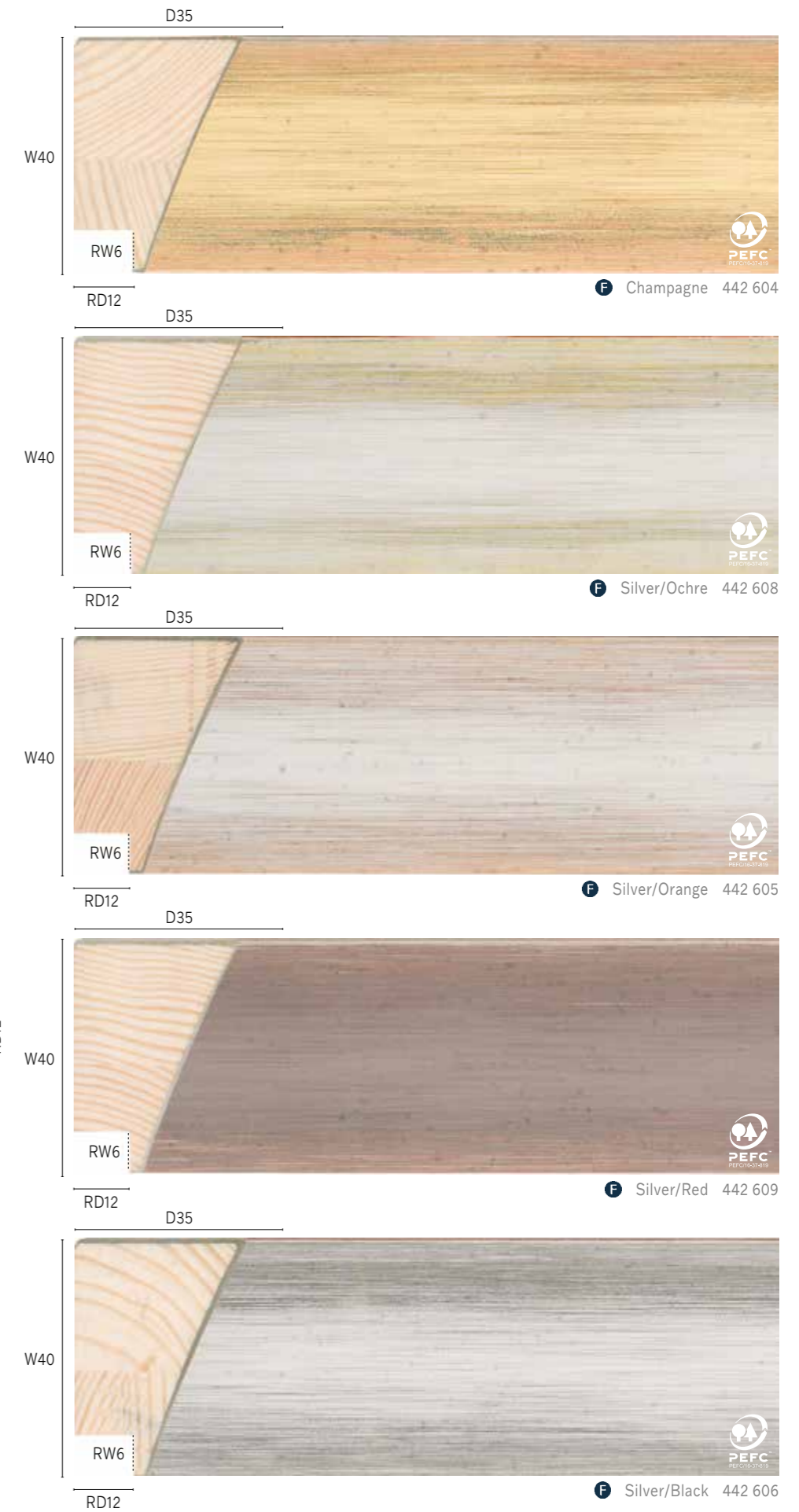
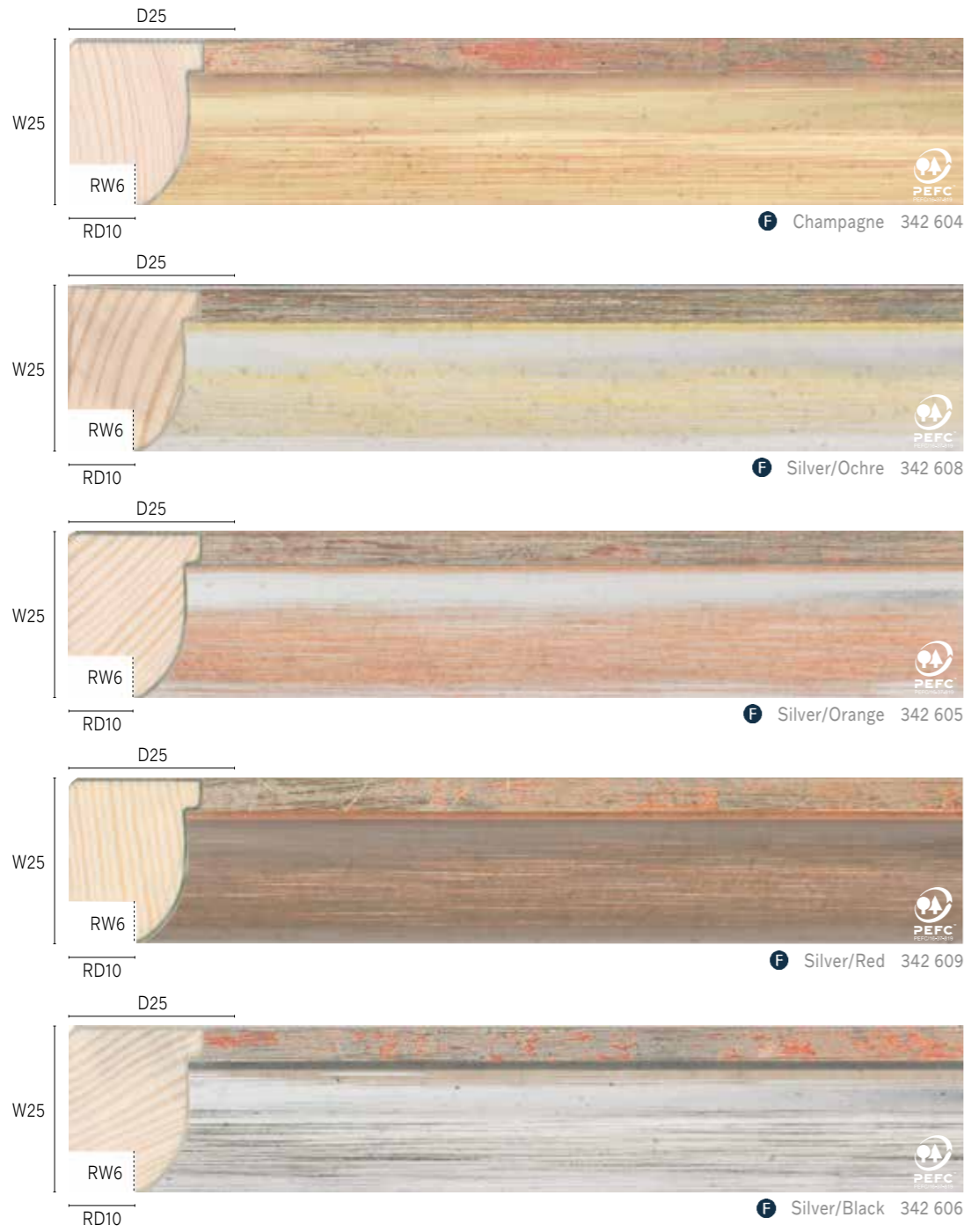

Mantilla

Mantilla's three warm finishes include Gold, Silver and Brown. The antiqued neutral tones are accented with soft, textured highlights and aged charm, connecting a timeless craft to modern world. With its delicate scrollwork, Mantilla would beautifully frame line drawings, book plates, antique jewellery and lace.



Moulding used
720 662

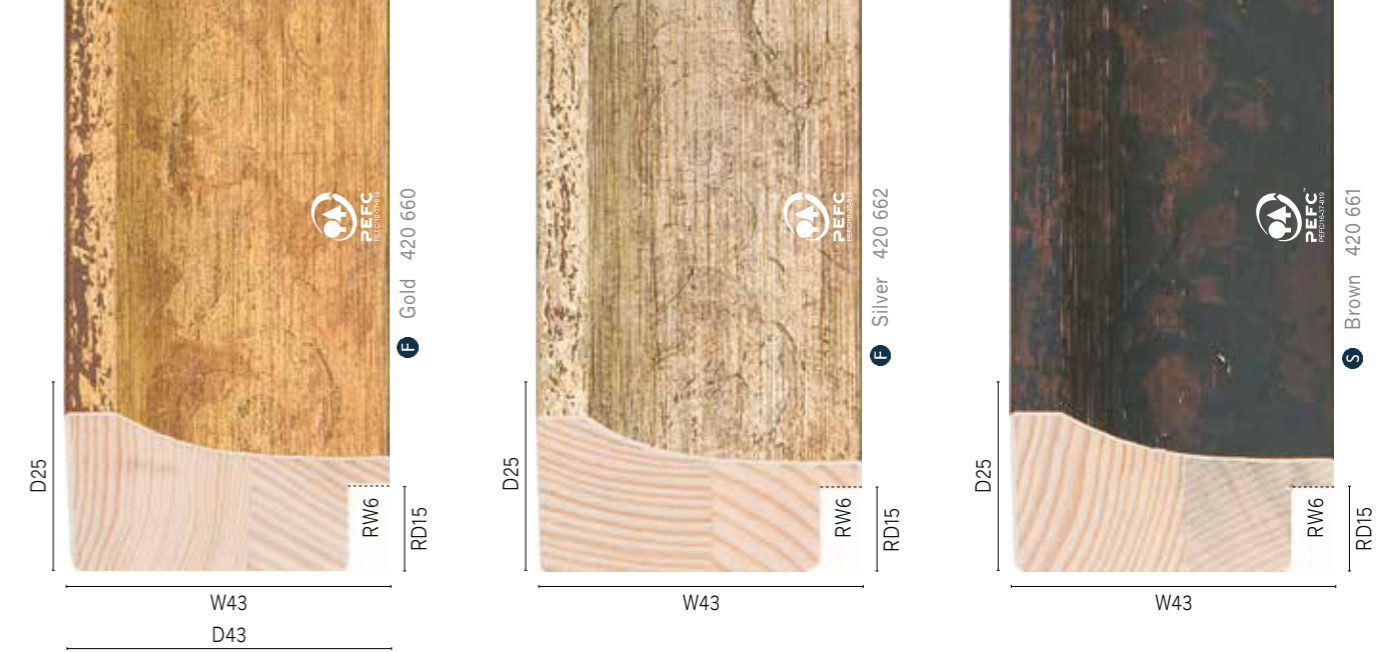

Marais

Inspired by the art, architecture, and decorative collectables gathered from 20th century European tours, Marais mixes classic beauty and charm with a unique finish and delicate embossings. French Ebony is a unique, ebonised black walnut finish with a slight grey patina and a subtle wood grain texture.



Moulding used
357 593

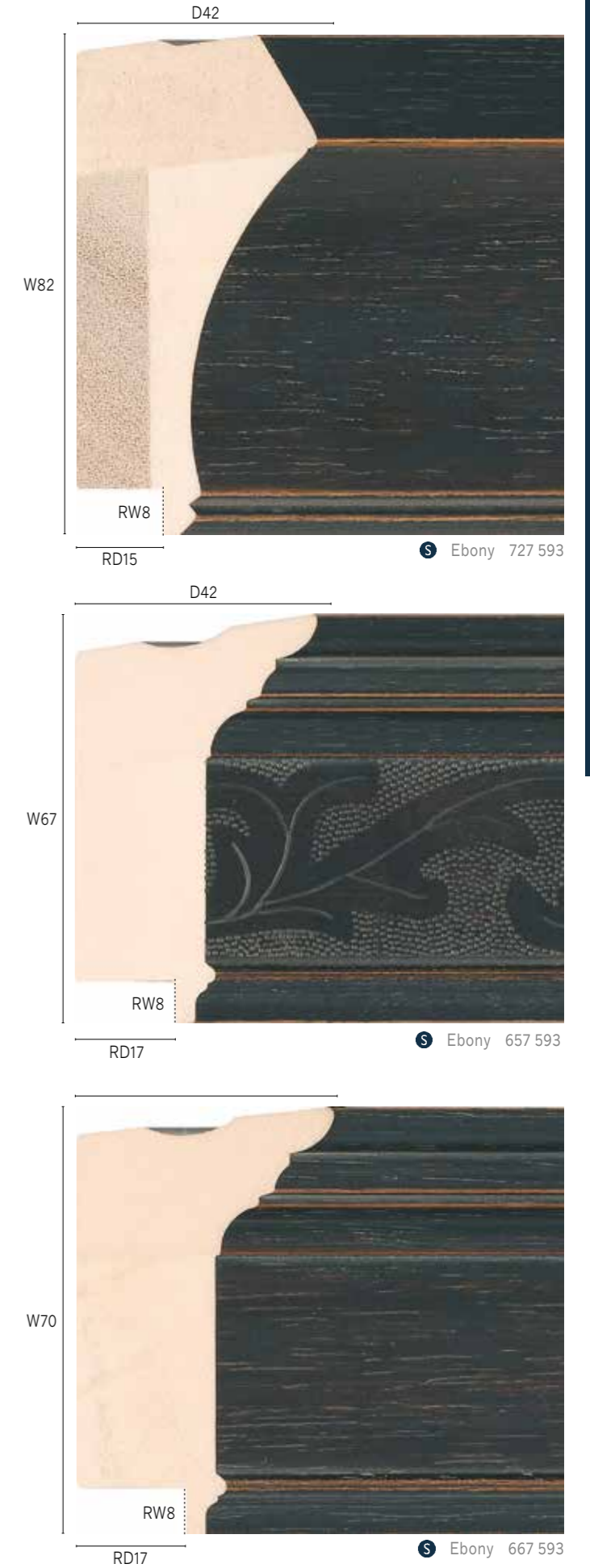
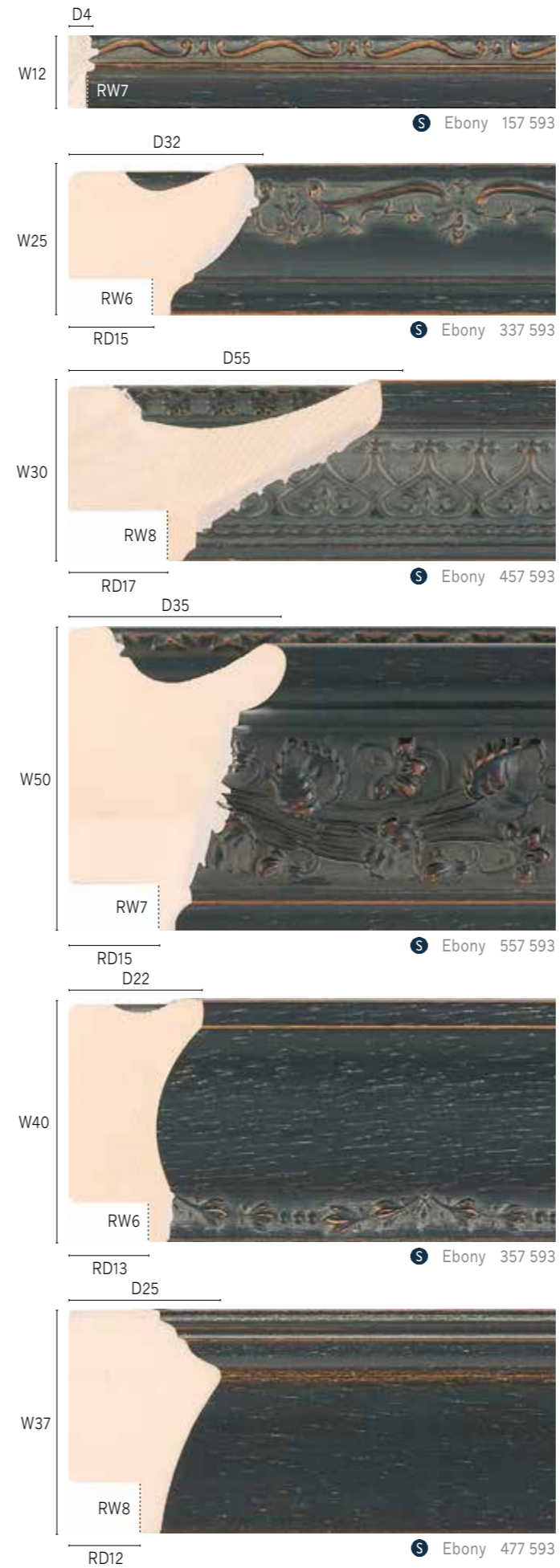

Michelangelo and Michelangelo II

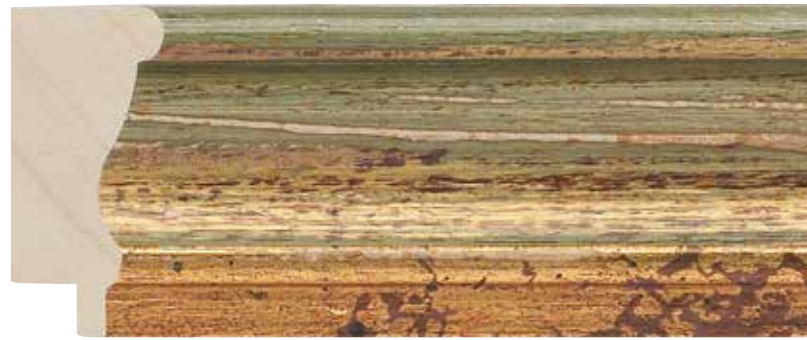

Michelangelo has an aged antiqued look that will suit all types of artwork. Two scoop profiles in four colours - Ivory, Green, Blue and Black. All have a gold sight edge.



Moulding used
664 9GN

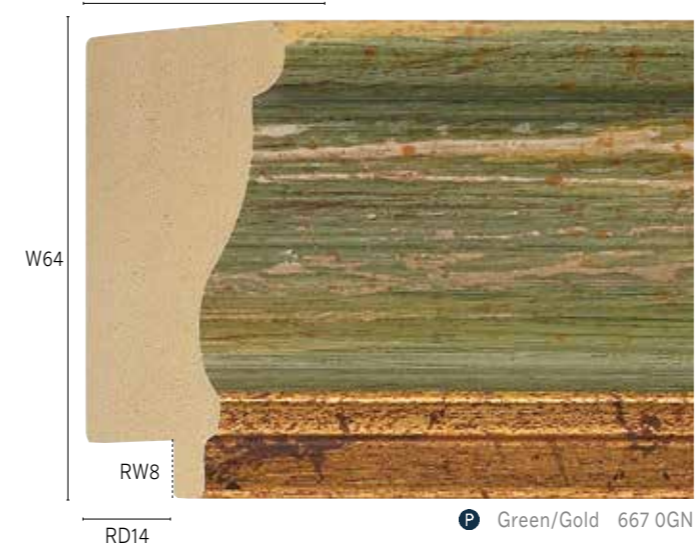
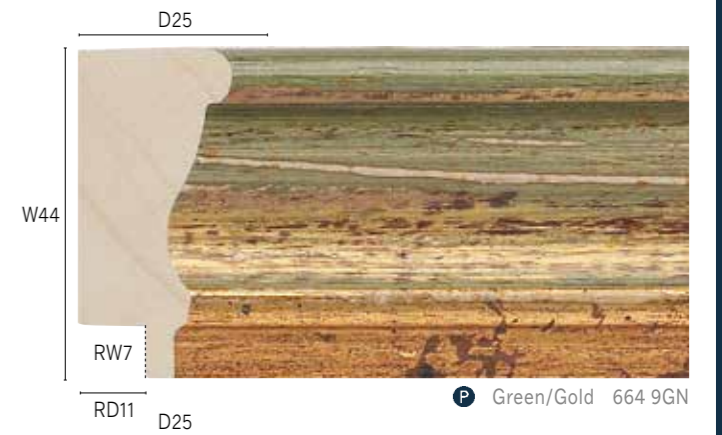



Micro-tech Veneers offer a high quality, high specification raw material combined with Italian technical innovation and efficiency. Designed to meet current mass market trends and tones in décor. They are ultra thick performance veneers with truer, long lasting colours.

Moulding used
809 16



Micro-tech Veneers



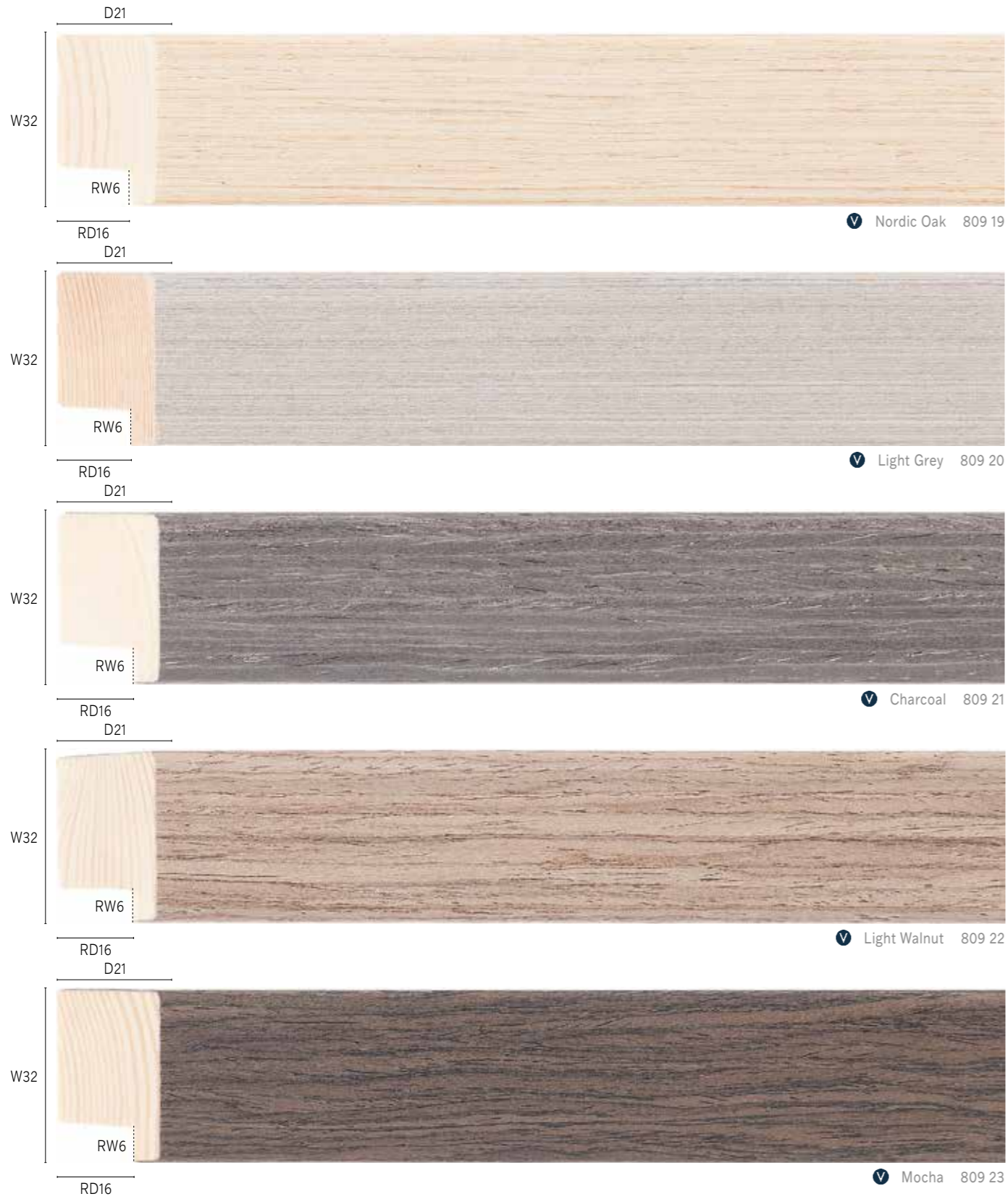

Petite I and II

Petite offers a collection of finishes from gold and transitional pewter and copper tones to sleek contemporary black. This mixture of profiles includes clean-lined contemporary and classic modern shaping.



Moulding used
334 133



<p>D26 W20 RW7 RD13 F Silver 234 924</p>	<p>D26 W20 RW7 RD13 F Black 234 929</p>
<p>D26 W20 RW7 RD13 F Pewter 234 925</p>	<p>D25 W19 RW7 RD14 F Pewter 230 130</p>
<p>D26 W20 RW7 RD13 F Bronze 234 926</p>	<p>D25 W19 RW7 RD14 F Bronze 230 131</p>
<p>D26 W20 RW7 RD13 F Gold 234 927</p>	<p>D19 W24 RW7 RD14 F Bronze 334 133</p>
<p>D26 W20 RW7 RD13 F Copper 234 928</p>	

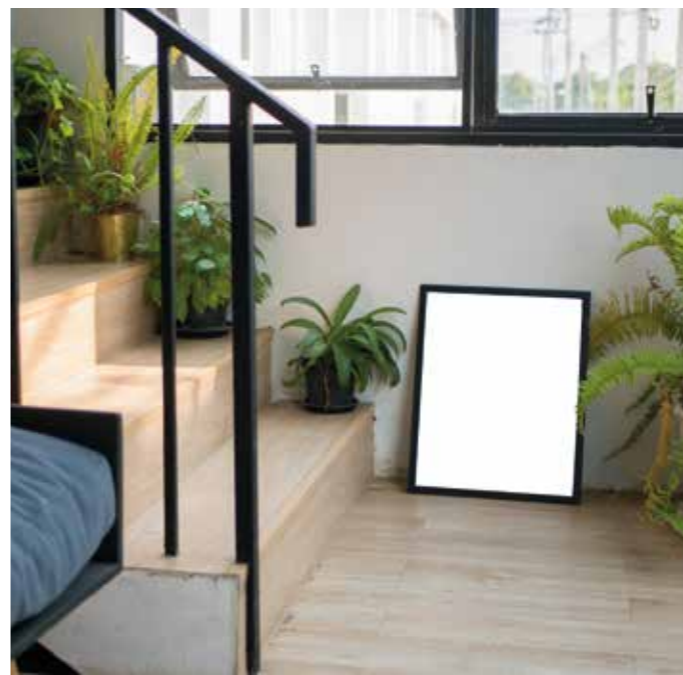

<p>D25 W19 RW7 RD13 F Black 230 132</p>	<p>D19 W24 RW7 RD13 F Pewter/Silver 334 134</p>
---	---

Prague

Our Prague collection has deeply carved patterns and antique gilding ideal for that wow factor. Inspired by the baroque and neo-classical periods when deep carving complemented architectural design.

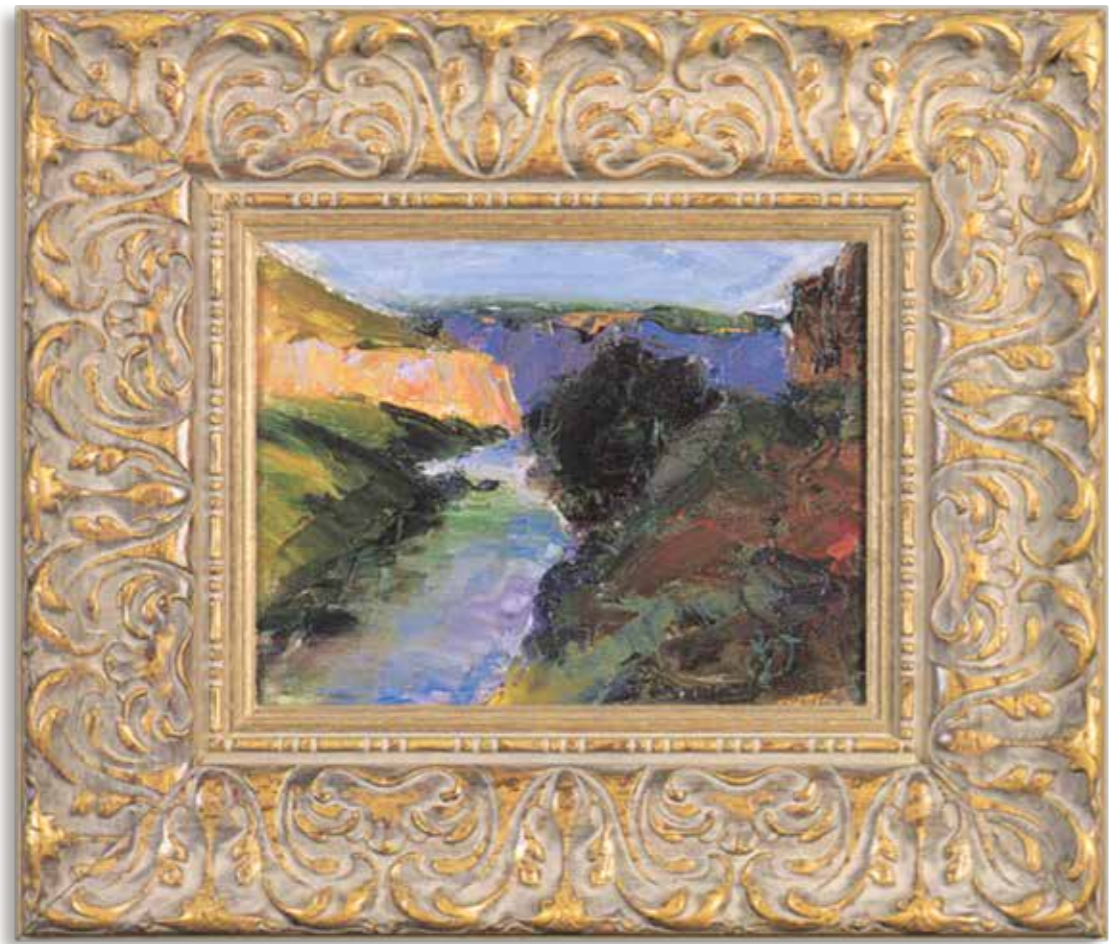

Moulding used
869 075





Sevilla Brown

The antiqued finish of the Sevilla Brown range features cracking and patina that allow the beauty of the wood to show through



Moulding used
500 542

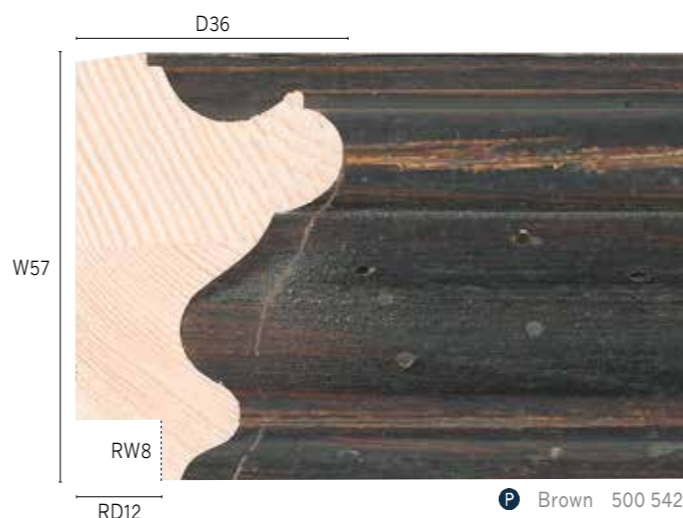

Sevilla Gold

The antiqued finish of the Sevilla Gold range offers an alternative colour choice whilst retaining the beautiful cracks and patina finish.

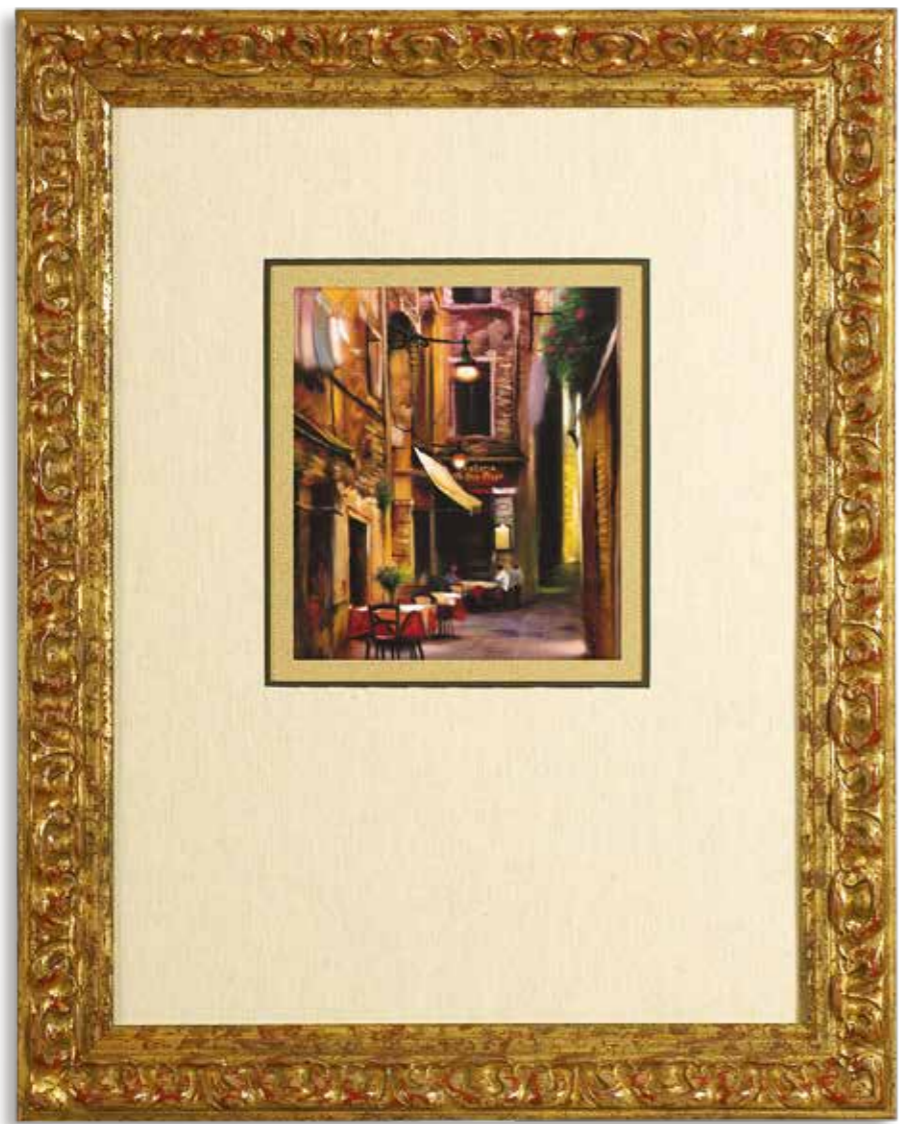

Moulding used
550 540

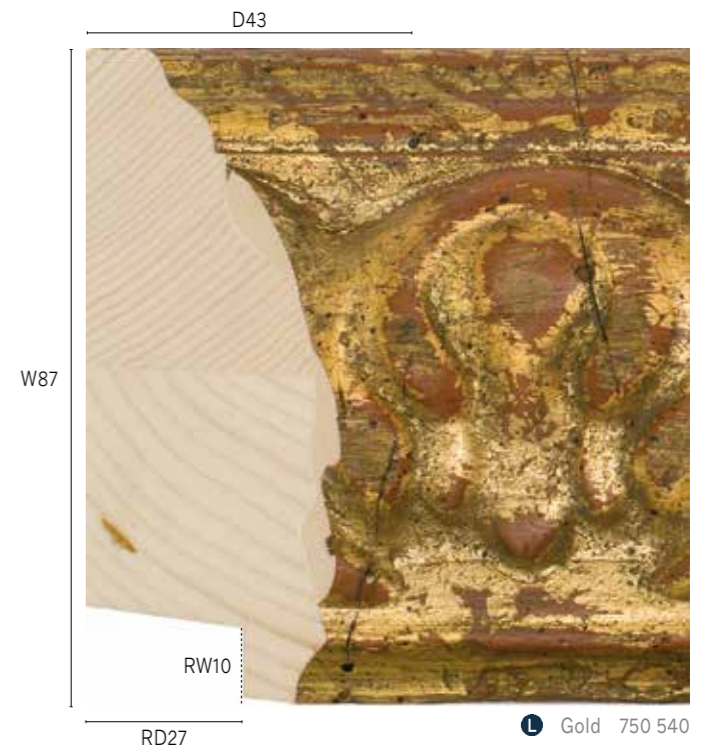
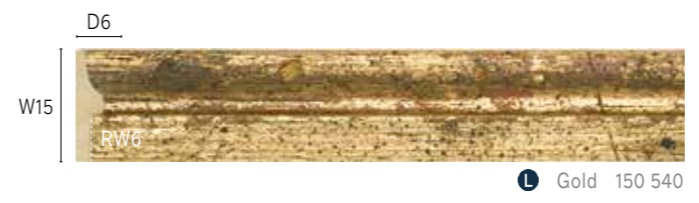

Sevilla Silver

As with the gold range, the Sevilla Silver allows the beauty of the wood to feature through the cracking and patina of each moulding.



Moulding used
450 541

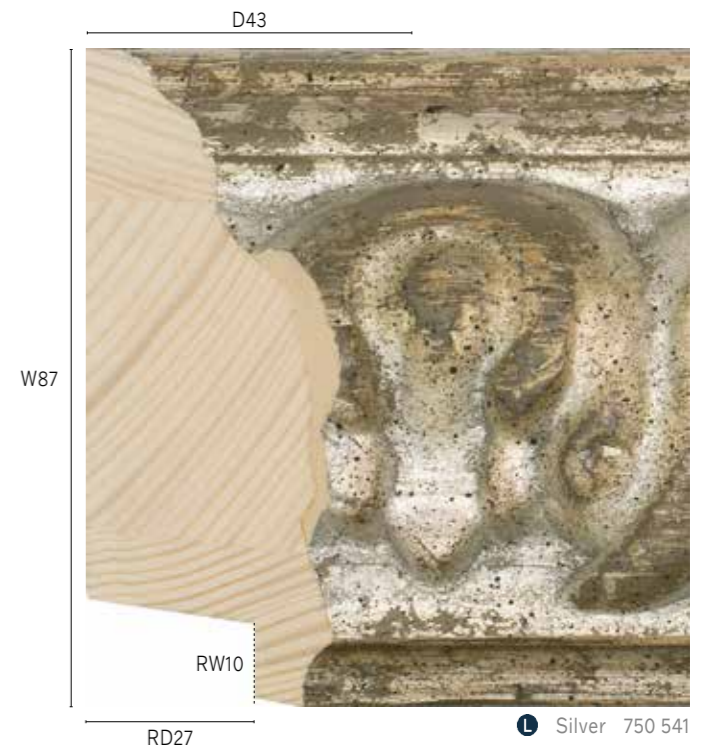
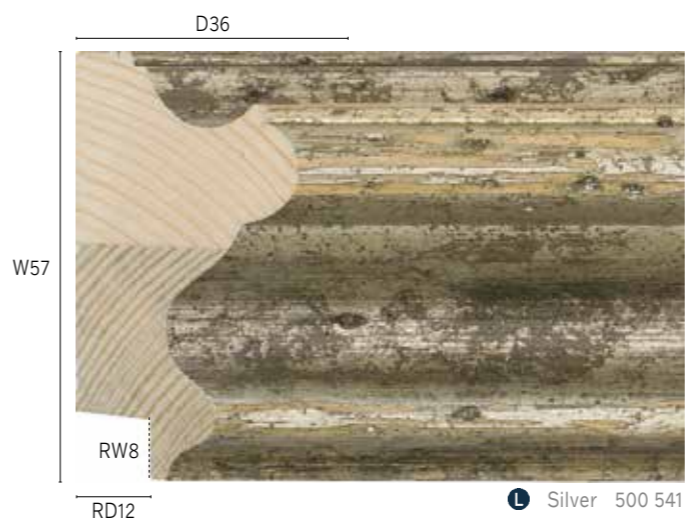
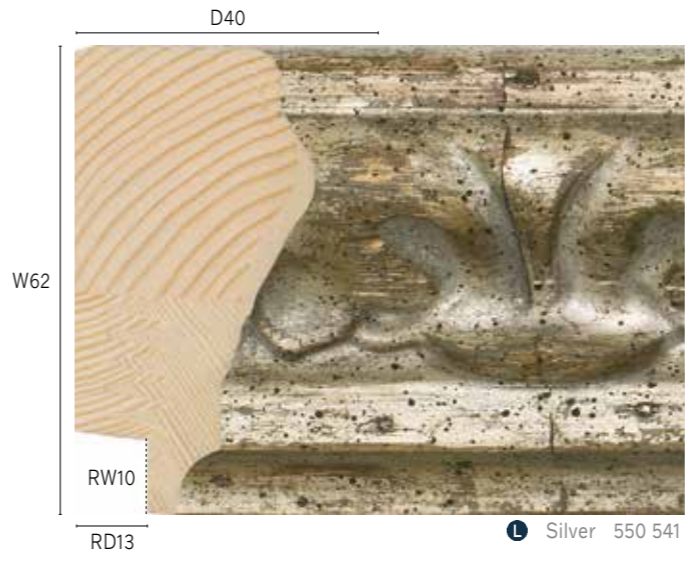



The antiqued finish of the Sevilla White range features cracking and patina that allow the beauty of the wood to show through.

Sevilla White



Moulding used
600 534

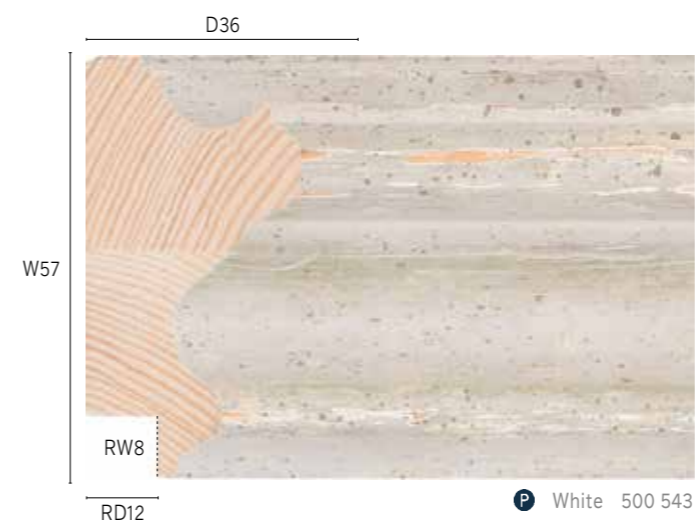

Sofia

Named after the capital city of Bulgaria, the Sofia frame collection reflects the classic beauty of this ancient city. There are two unique metallic finishes in the Sofia frame collection. The Iron and Silver luminous finishes highlight the beauty of the ornamental frames, and the hand applied matte patina adds a subtle, soft antiquing.



Moulding used
430 752

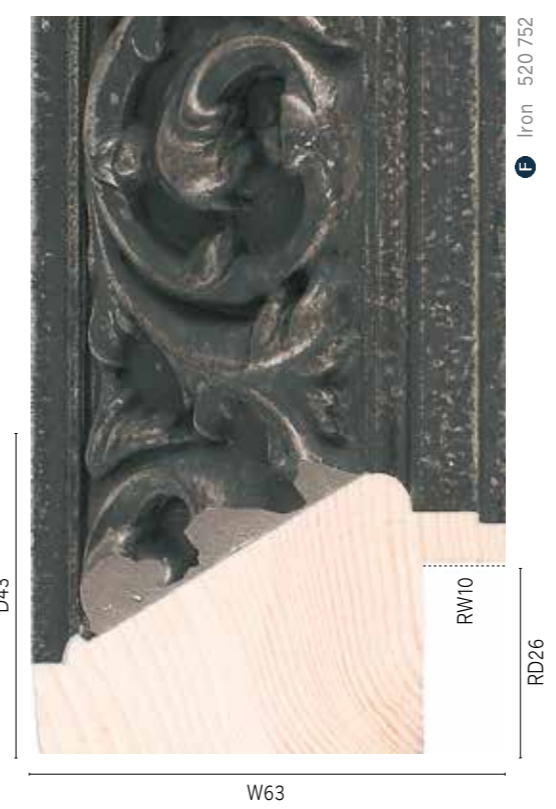
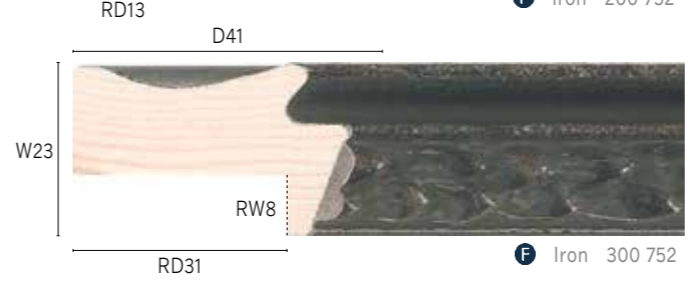
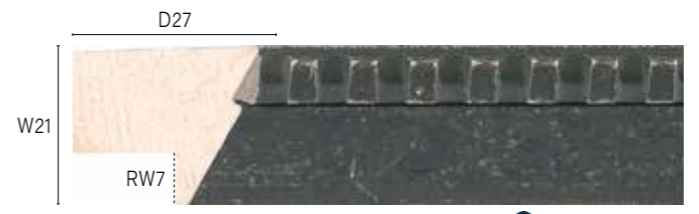



Soho

Soho is a contemporary collection of smooth black satin finish mouldings with contrasting gold and silver accents. Named after the cosmopolitan neighbourhood of New York 'South of Houston' where much of the contemporary art world began, Soho ideally complements black and white photography and abstract art. We believe that the range offers an excellent alternative to metal mouldings when crisp, geometric lines are needed.



Moulding used

671 086

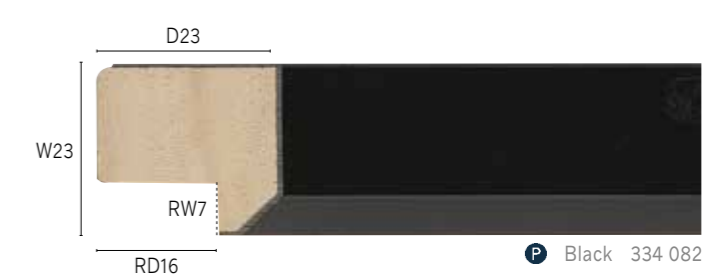
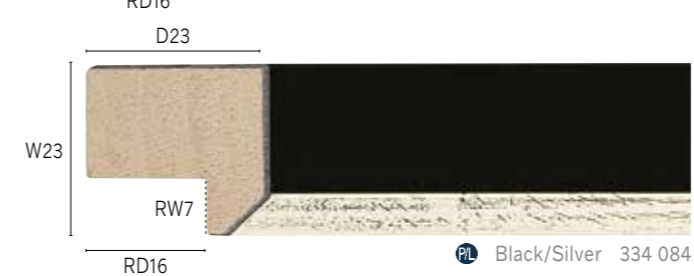

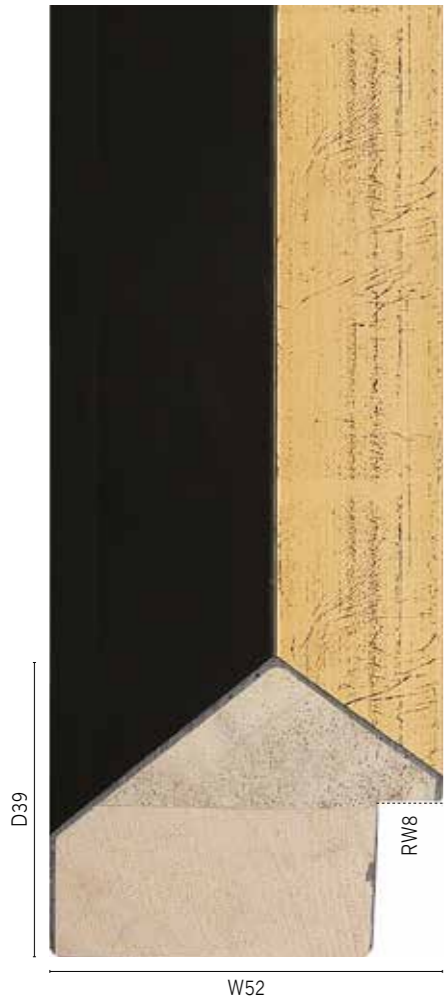

PL Black/Gold 439 086



PL Black/Silver 439 084

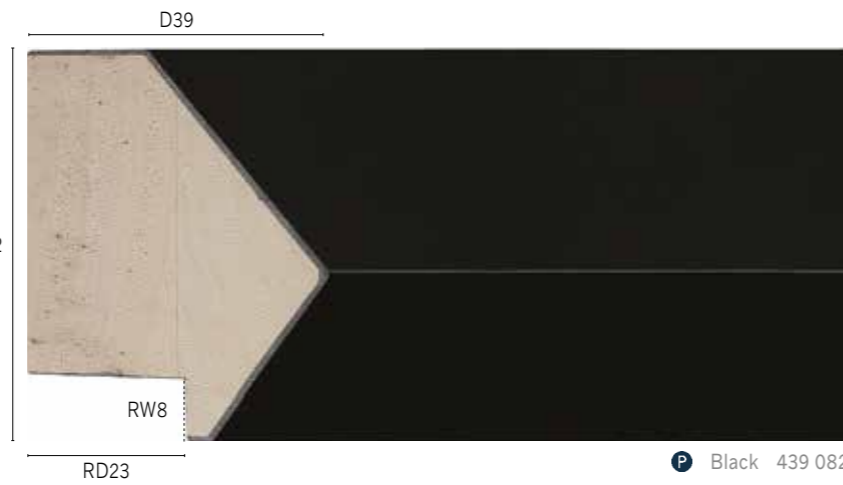

P Black 439 082



PL Black/Gold 671 086

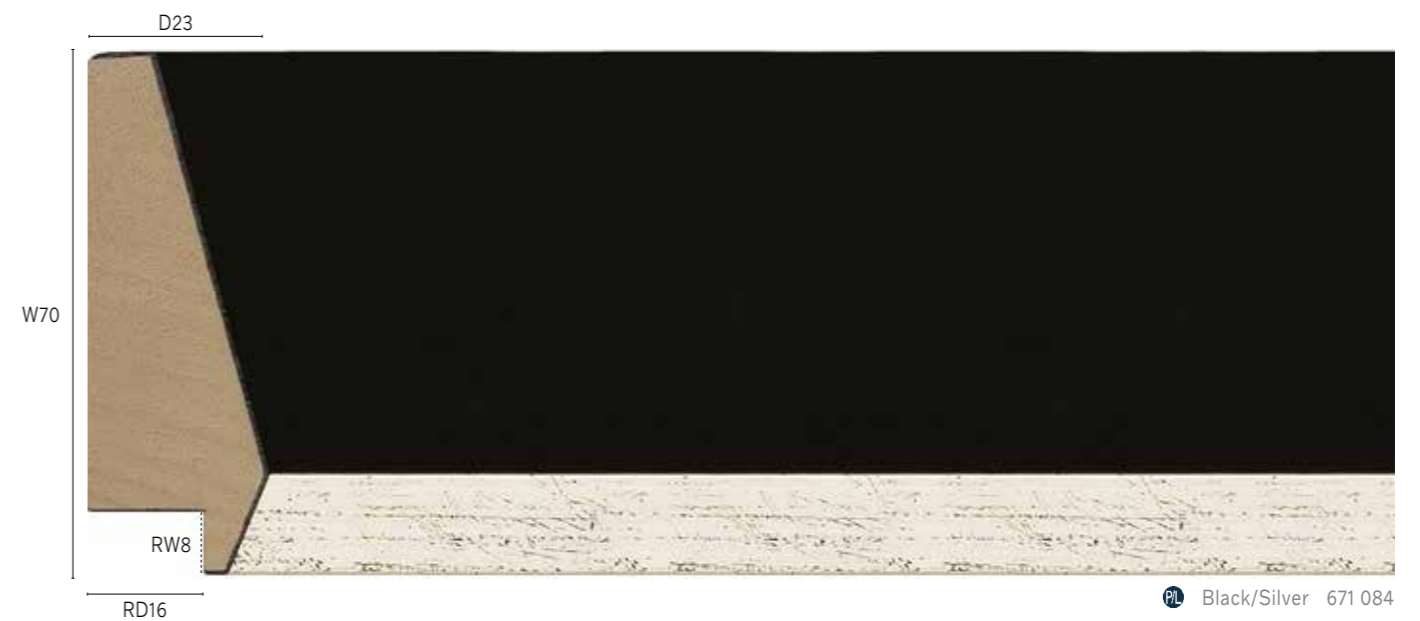

PL Black/Silver 671 084



P Black 671 082

Spoletto



Spoletto is inspired by the ancient Italian city, that dates back to the bronze age. This collection answers the interest in vintage repurposed with a modern and sleek twist. Soft texture and layered metallic lend a modern aesthetic. Ideal for framing contemporary art, botanicals or modern photography with versatile profiles in a range of soft metallic finishes.



Moulding used

325 110
 Image by Garry Brander courtesy of
 Edinburgh Arts www.edinburgharts.com

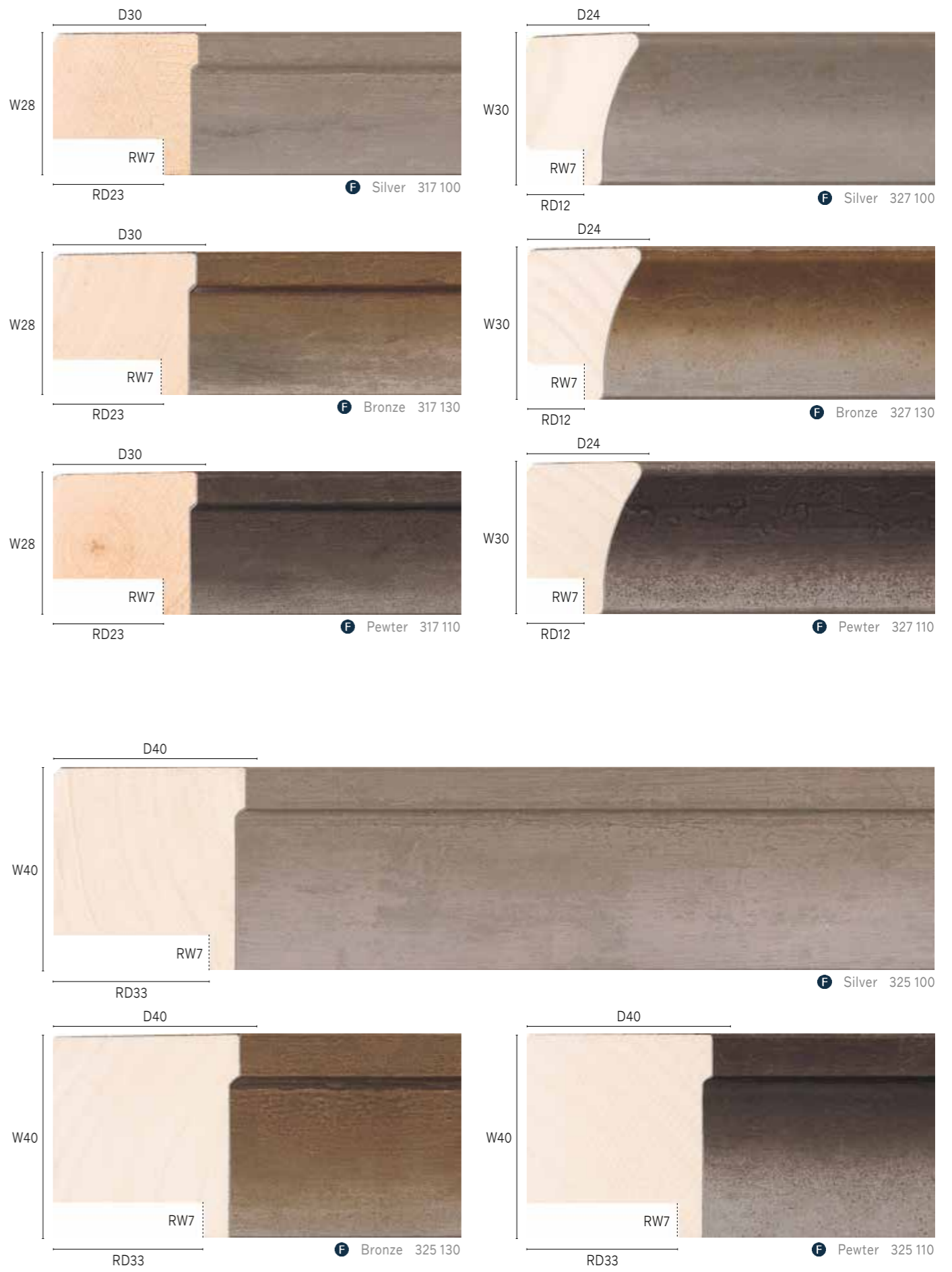



Tate

Tate was developed to fill the need for a new cold Silver in simple, modern shapes. At the same time, we also saw the opportunity to enhance the collection by adding a complementary burnished Black. Both finishes have subtle burnishing which adds sophistication and will make them both production and handling friendly. It is a functional collection forming a contemporary building block, in the Larson-Juhl line - whether used as a classic stand alone item or by adding its slick modern edge to stacked combinations.



Moulding used
380 660

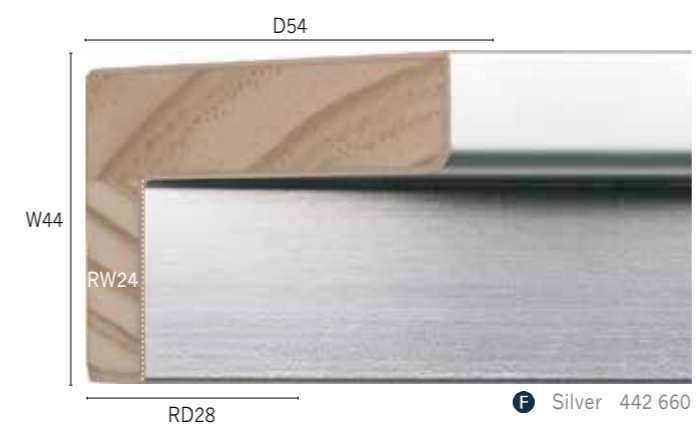
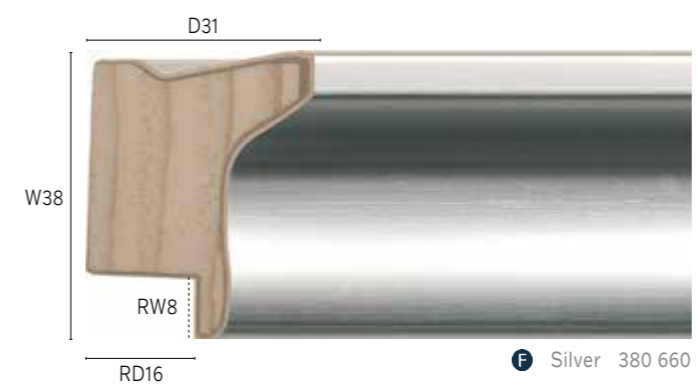
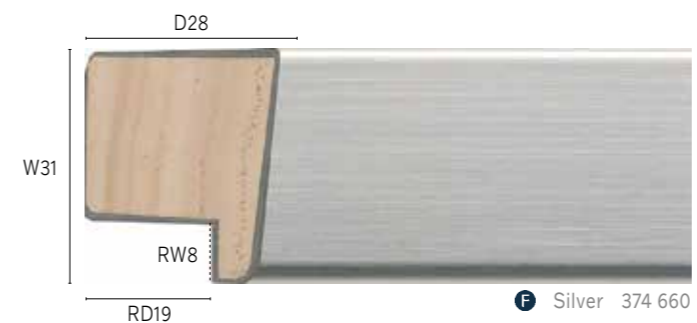
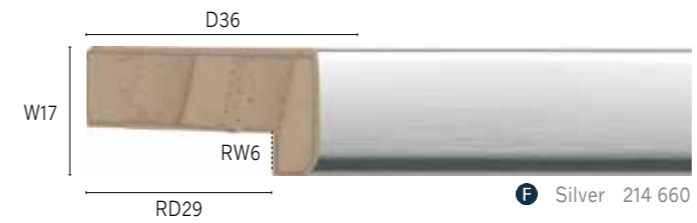
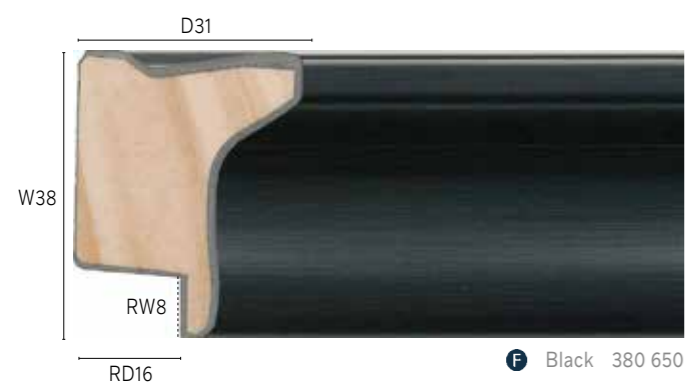
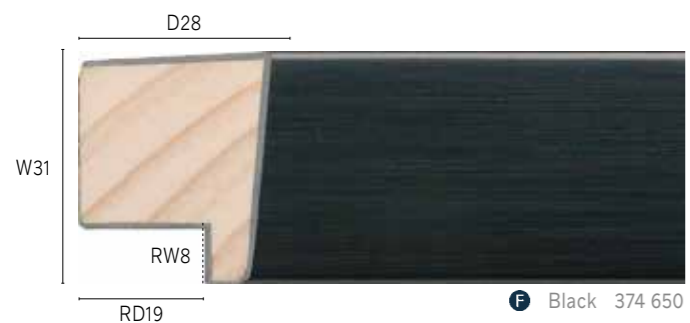

Whitman

Whitman's look is unique and handcrafted which will stand out in the market. Each length is a work of art, uniquely crafted by hand. Hand brushed/painted finishes are highly creative and provide design innovation. Hand applied hot gesso is the primary feature of the dark brown with visible brushstrokes. The soft textured look has the elegance of a fine European antique. To add definition to both colours soft champagne highlights and finely detailed compo elements are also featured on several items in the range.



Moulding used
565 403

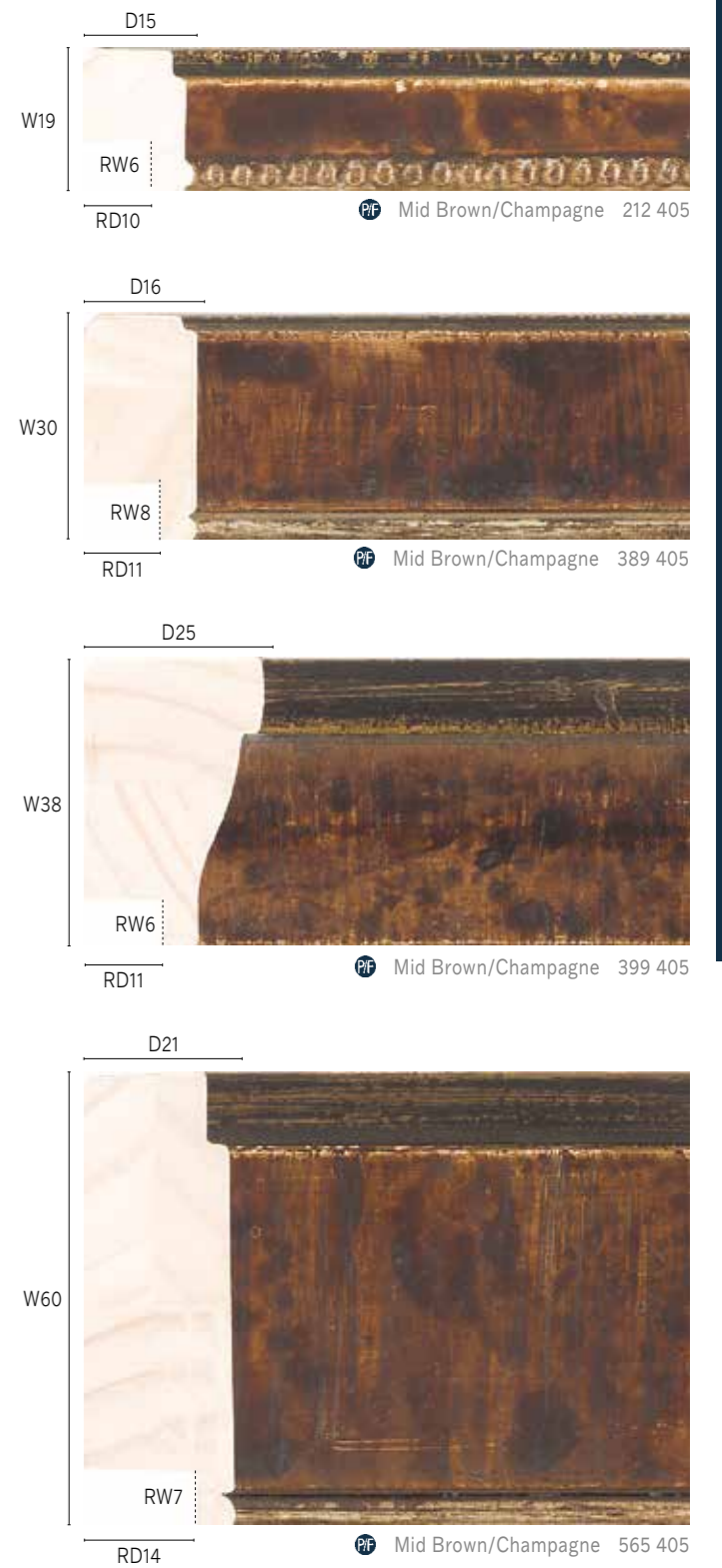
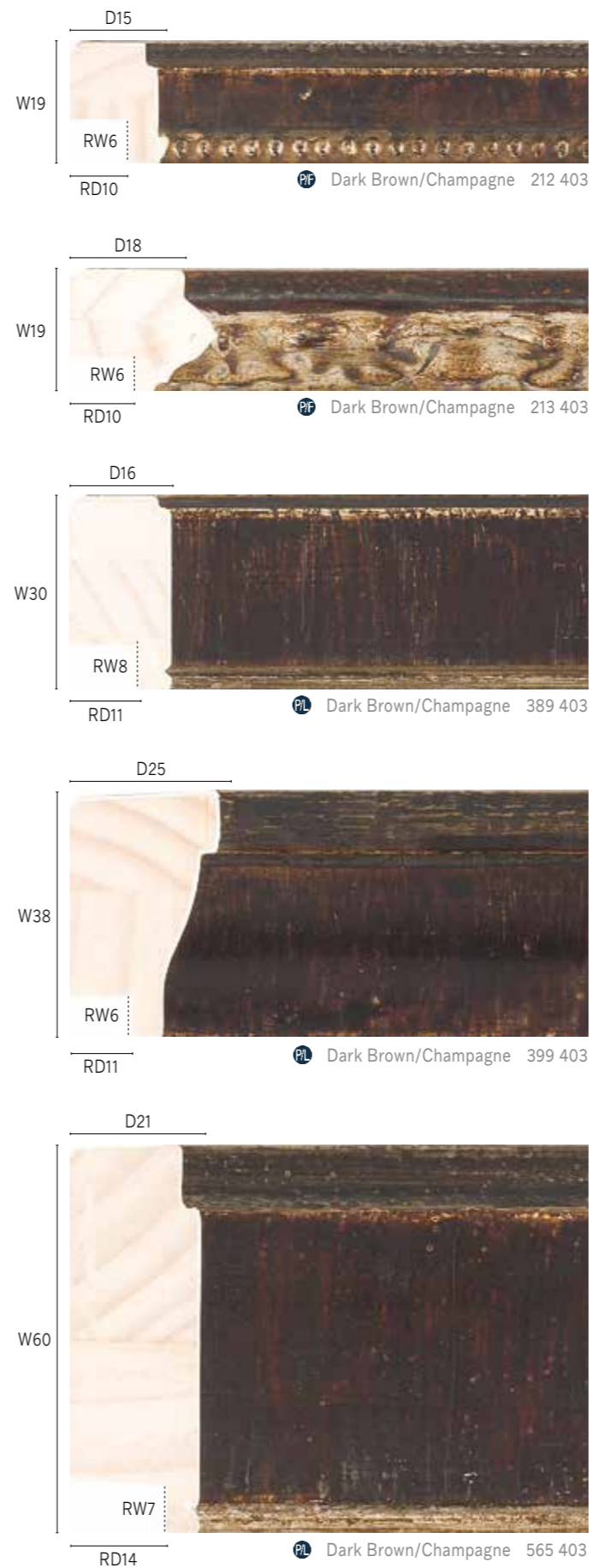



Zen

Zen's four calming finishes complement countless types of artwork including black and white photography, Asian inspired art and abstract paintings. Profile 411, with its simple, contemporary shape and gentle hammered, contrasting lip, is the perfect choice for photography, drawings and engraving. Profile 431 adds drama and depth with its deep rebate, the top edge highlighted with a hand-hewn hammered look and the inward sloping angle, gently draws focus to the artwork. This profile is a fantastic option for framing canvasses and three-dimensional work.



Moulding used
431 432

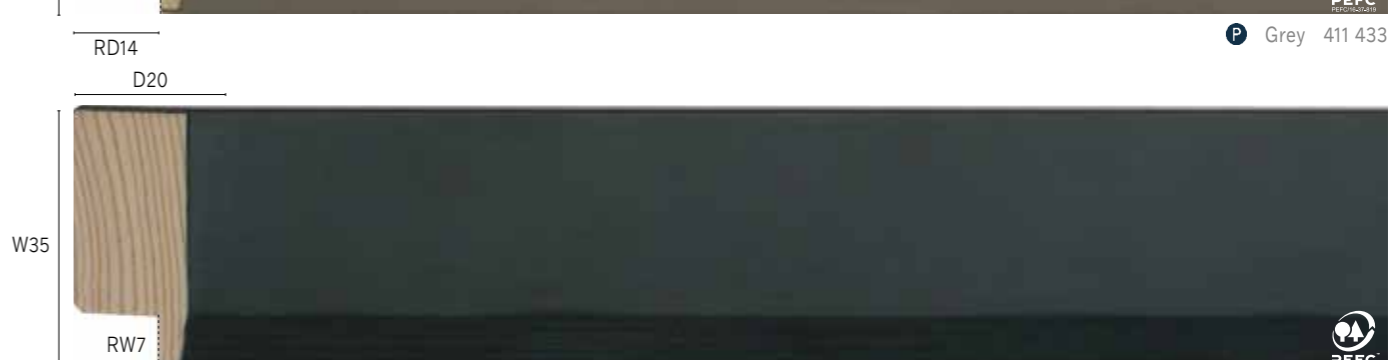

Plain Gold



Plain Gold

We offer a wide range of plain gold, white gold, copper and bronze mouldings in a variety of designs from ornate to contemporary.

All made to the highest specification from the foil finished profiles in the Andover range to the golden tones with natural rubbed edges of the Alora collection.



Moulding used

440 601 000



W10	D13	RW3	RD7	Gold 400 695 301
W12	D13	RW4	RD7	Gold 121 200 172
W13	D15	RW6	RD10	Gold 499 202 000
W12	D15	RW4	RD7	Gold 240 485 100
W13	D19	RW5	RD8	Gold 141 200 172
W14	D20	RW5	RD11	Gold 142 200 108
W17	D22	RW5	RD12	Gold 498 202 000
W10	D15	RW6	RD9	Gold 482 247 000
W13	D17	RW5	RD8	Gold 233 250 500
W13	D15	RW4	RD7	Gold 442 139 246
W13	D16	RW5	RD9	Gold 209 283 000
W13	D15	RW5	RD9	Gold 732 0AG
W17	D17	RW5	RD8	Gold 491 246 000
W16	D17	RW4	RD9	Champagne/Black 231 750 673
W16	D17	RW4	RD9	Gold/Black 231 750 753
W16	D17	RW4	RD9	Gold/Black 231 750 753
W16	D17	RW4	RD9	Bronze/Black 231 750 773
W23	D15	RW5	RD11	Champagne 430 301 000
W13	D11	RW6	RD7	Gold 421 247 000
W15	D14	RW5	RD8	Gold 115 246 000
W20	D14	RW5	RD9	Gold 252 300 000
W23	D20	RW8	RD13	Gold 618 247 000
W34	D20	RW13	RD10	Gold 614 247 000
W12	D17	RW5	RD9	Gold 211 310 120
W12	D20	RW5	RD10	Gold 211 312 340
W20	D16	RW5	RD10	Gold 211 312 340
W15	D16	RW5	RD9	Gold 070 1AG

W15	D16	RW4	RD8	Gold 285 244 000
W17	D15	RW4	RD8	Gold 415 202 000
W22	D38	RW4	RD23	Gold 392 1AG
W18	D17	RW5	RD7	Gold 218 801 245
W18	D17	RW5	RD7	Gold/Green 218 801 238
W21	D19	RW6	RD7	Gold 418 801 245
W21	D19	RW6	RD7	Gold/Green 418 801 238
W21	D19	RW6	RD7	Gold/Blue 418 801 248
W21	D19	RW6	RD9	Gold/Green 224 126 238
W21	D19	RW6	RD7	Gold/Red 418 801 249
W21	D16	RW5	RD8	Gold 447 246 000
W22	D16	RW6	RD8	Gold 450 246 000
W24	D16	RW7	RD5	Gold 426 430 000
W22	D16	RW6	RD9	Gold/Ivory 224 126 000
W22	D16	RW6	RD9	Gold/Red 224 126 363
W22	D16	RW6	RD9	Gold/Green 224 126 238
W22	D16	RW6	RD9	Gold 224 126 600
W22	D15	RW5	RD7	Gold 308 244 000
W22	D15	RW9	RD7	Gold 308 444 000
W25	D15	RW9	RD10	Gold 461 244 000
W34	D12	RW10	RD9	Gold 444 244 000
W25	D15	RW6	RD8	Gold 215 130 000

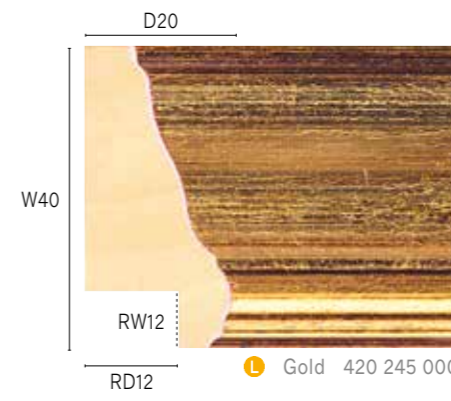
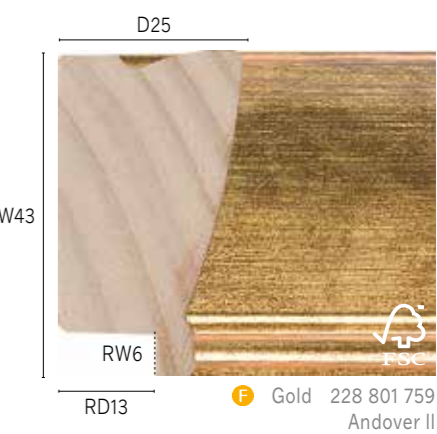
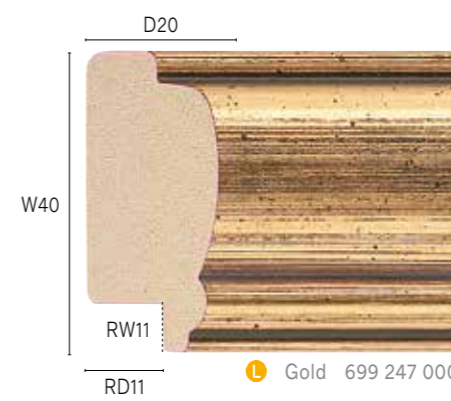
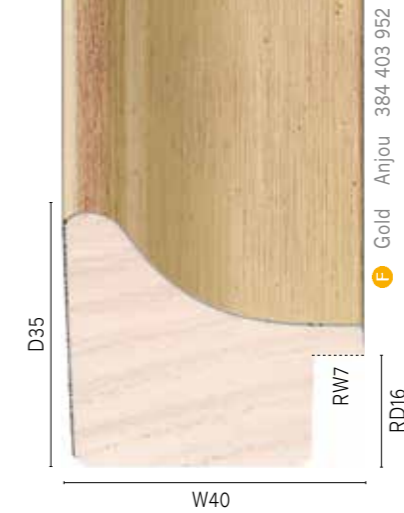
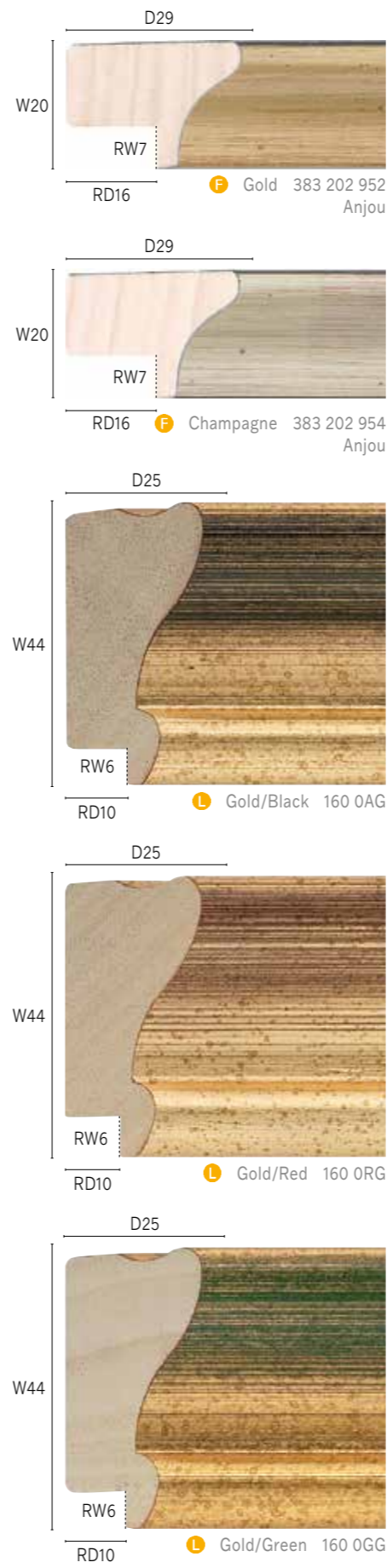
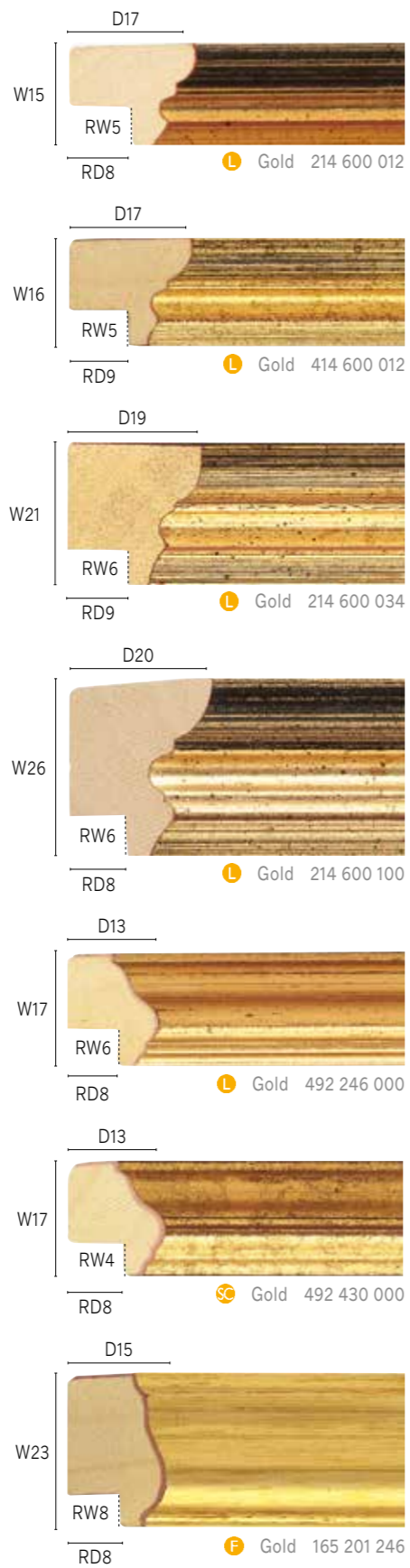
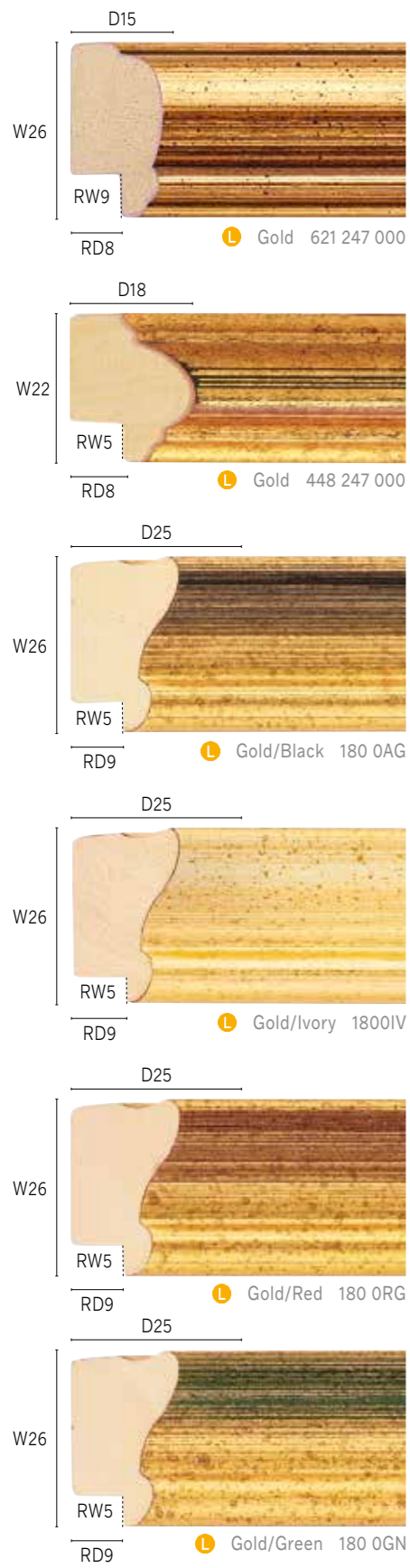

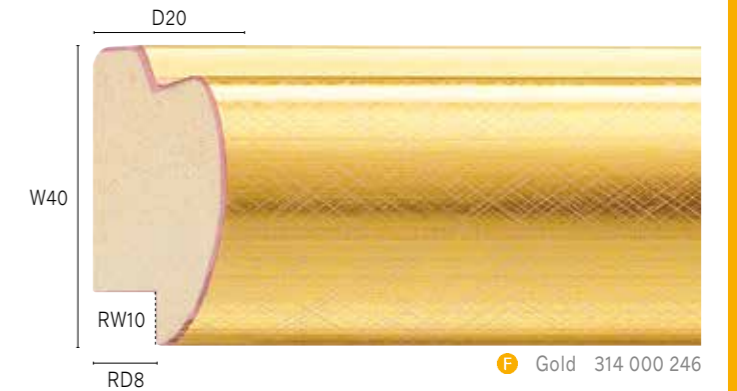
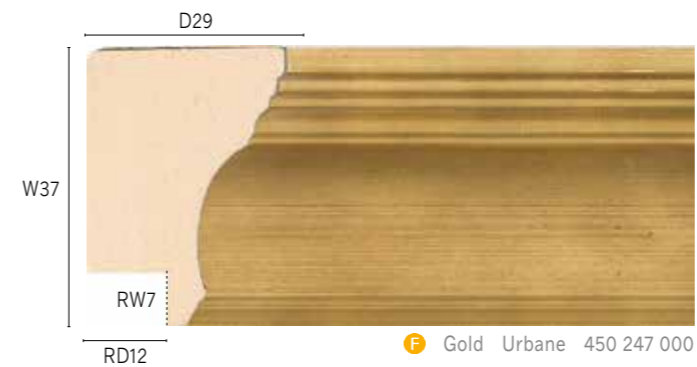
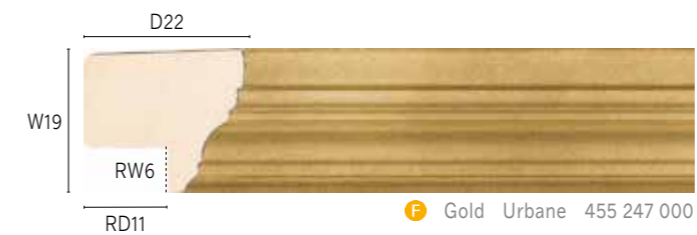
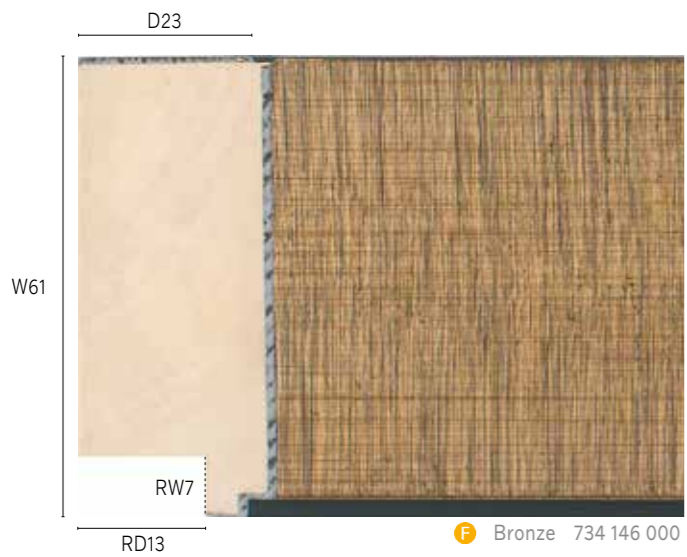
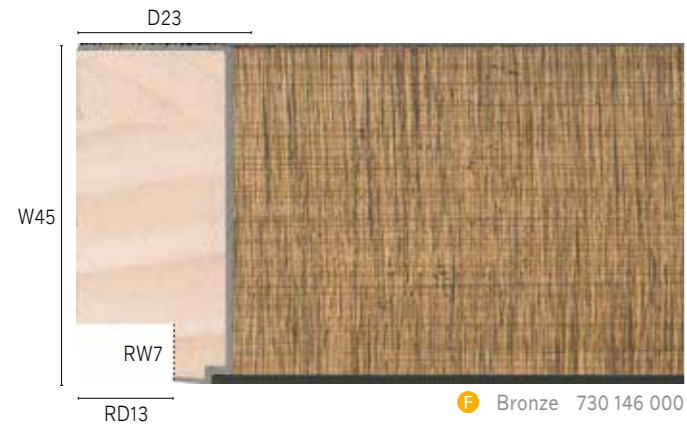
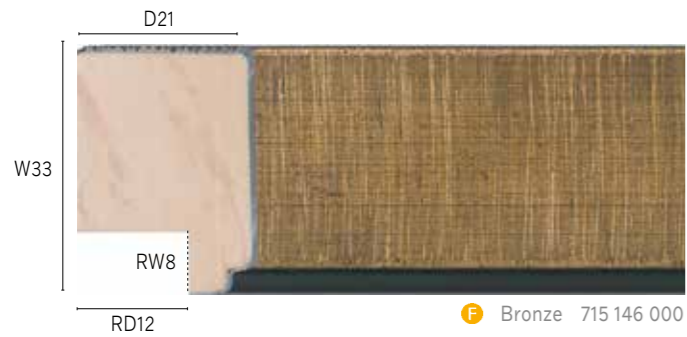

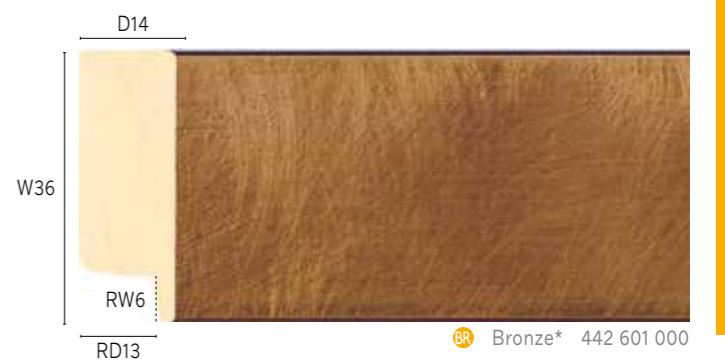
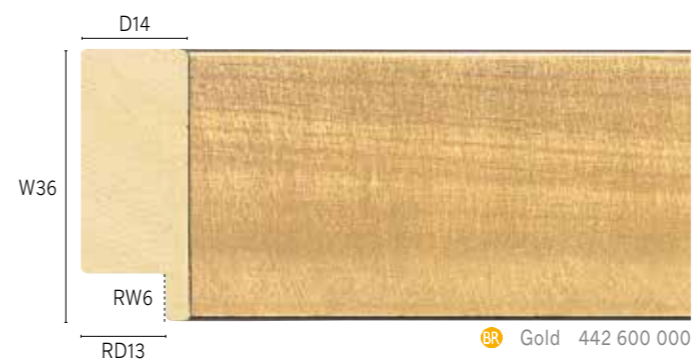

* See matching mountslips on page 374

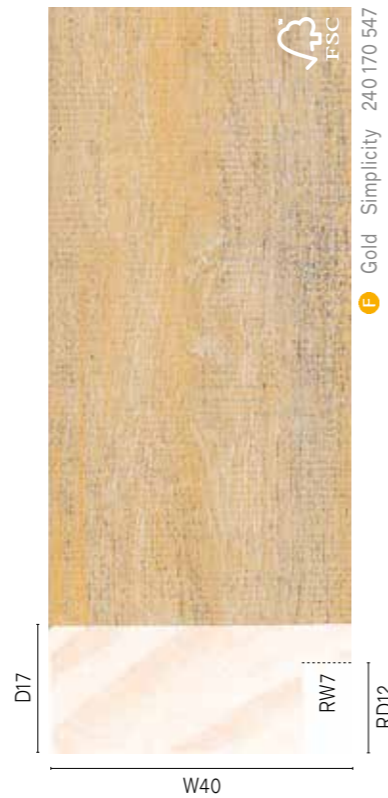
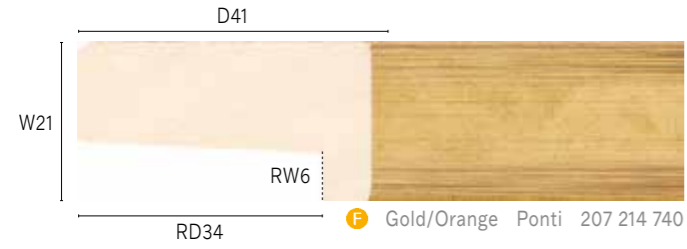
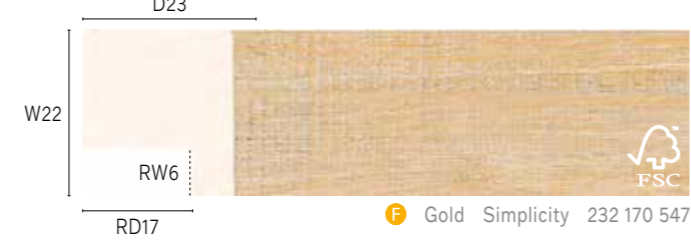
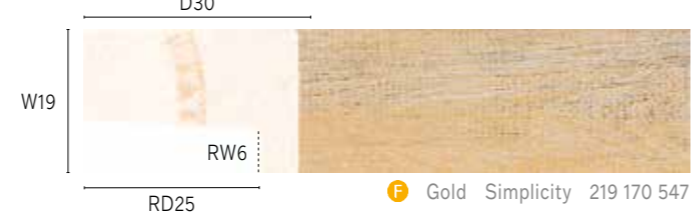
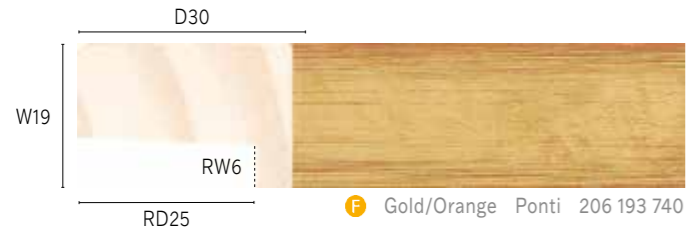

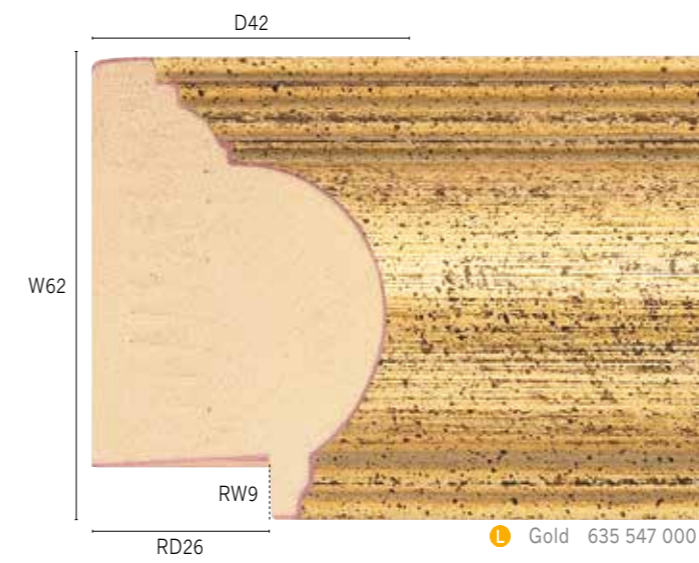
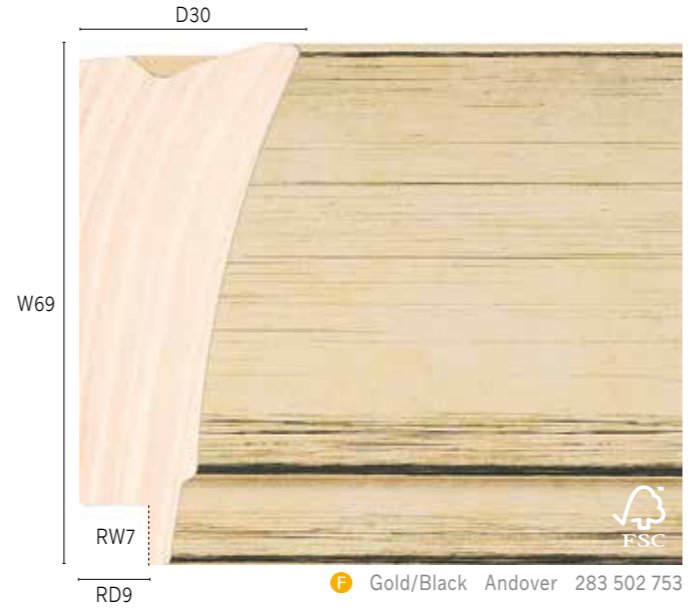



Champagne Hampshire II 292 201 640

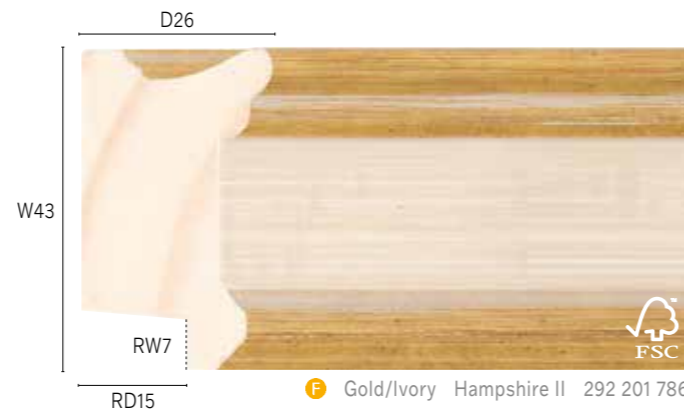

Gold/Ivory Hampshire II 292 201 786

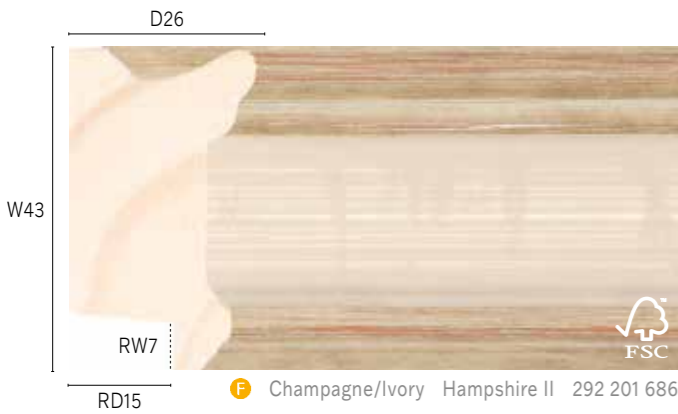

Champagne/Ivory Hampshire II 292 201 686

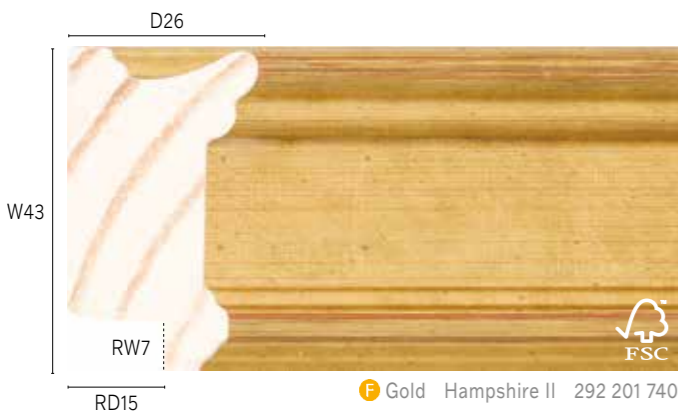

Gold Hampshire II 292 201 740

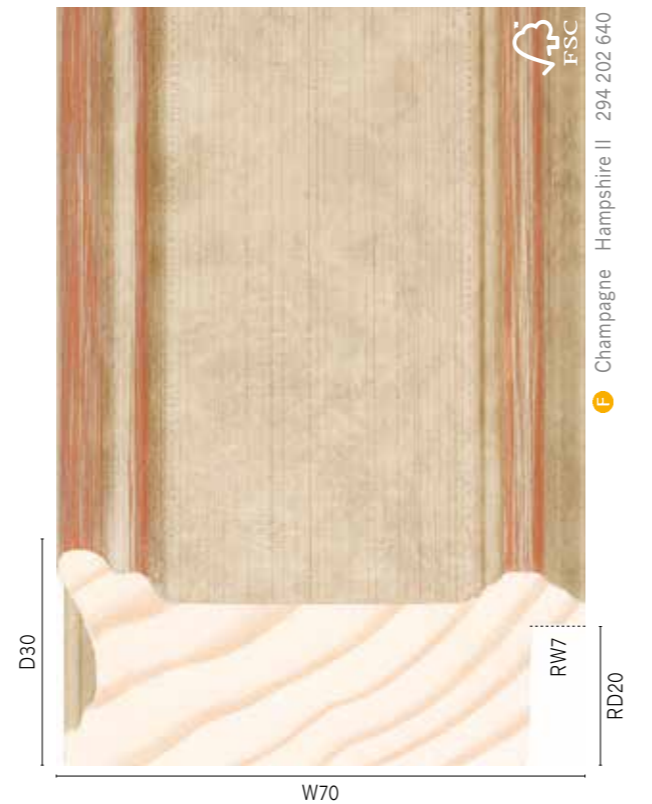

Champagne Hampshire II 294 202 640

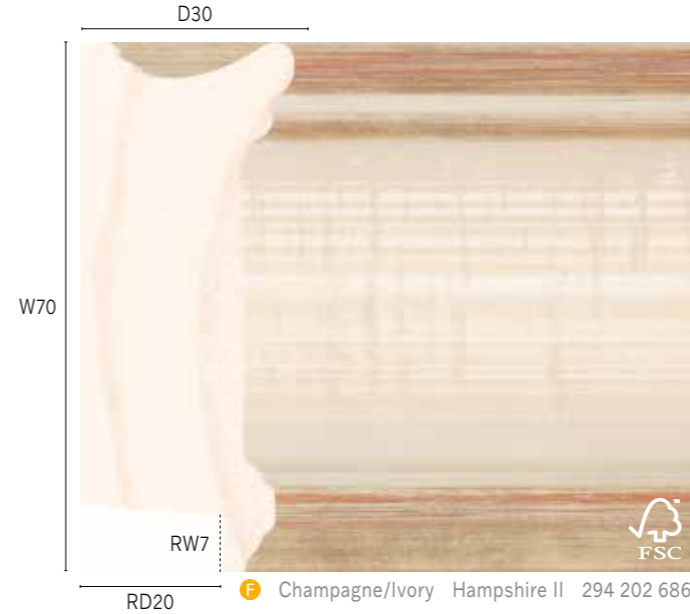

Champagne/Ivory Hampshire II 294 202 686



Champagne Hampshire II 294 202 740

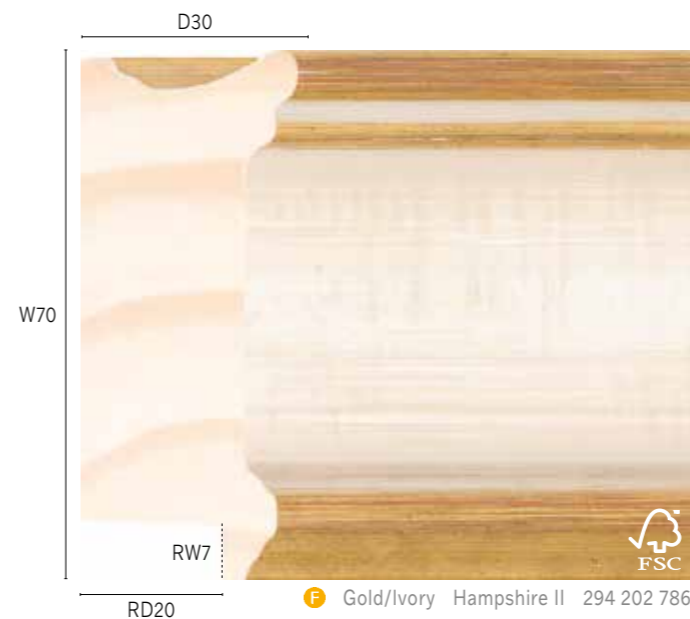

Gold/Ivory Hampshire II 294 202 786

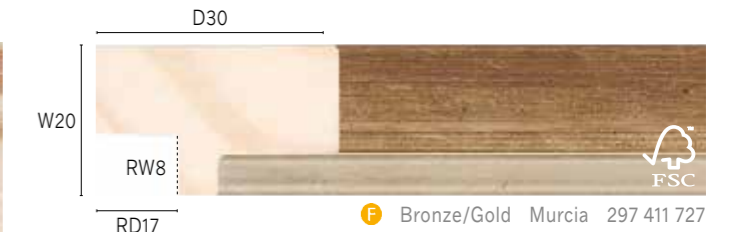

Bronze/Gold Murcia 297 411 727



Bronze/Gold Murcia 298 412 727



Bronze/Gold Murcia 299 413 727



Gold Alora 229 901 741

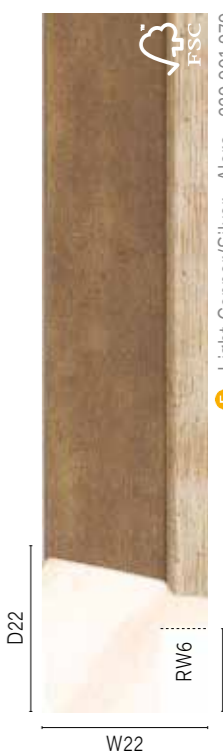

Light Copper/Silver Alora 229 901 979

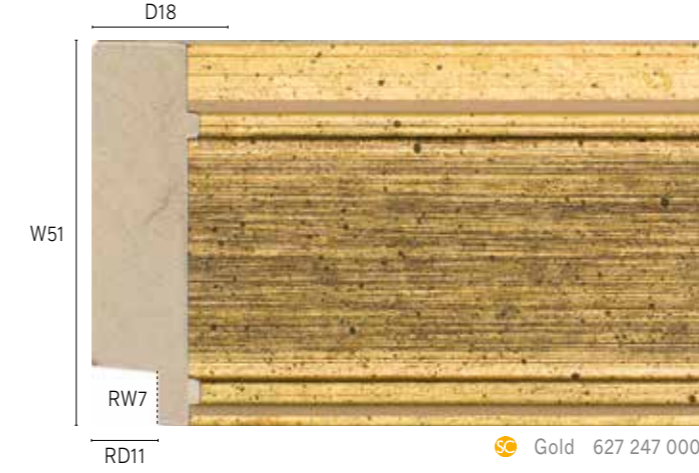
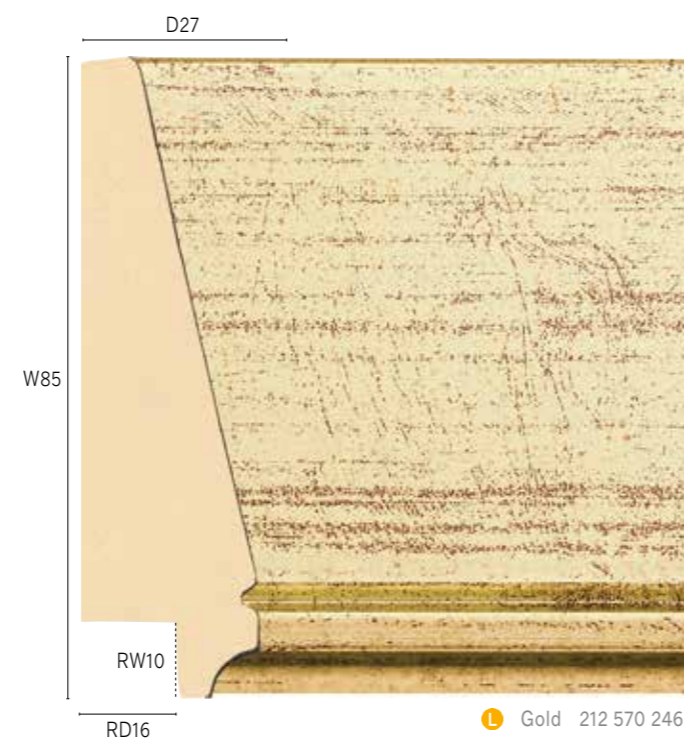
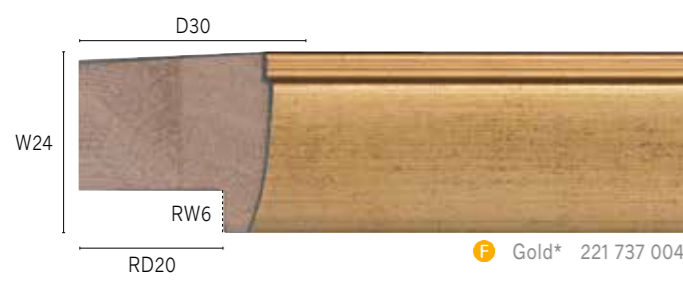
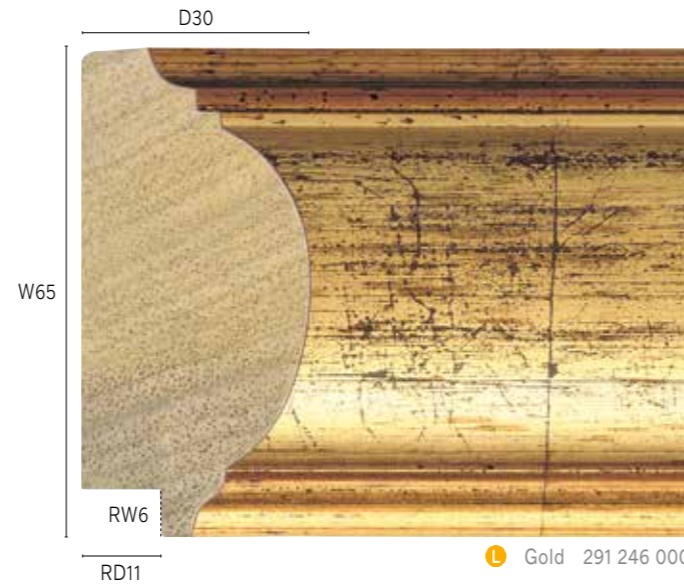

* See matching mountslips on page 374

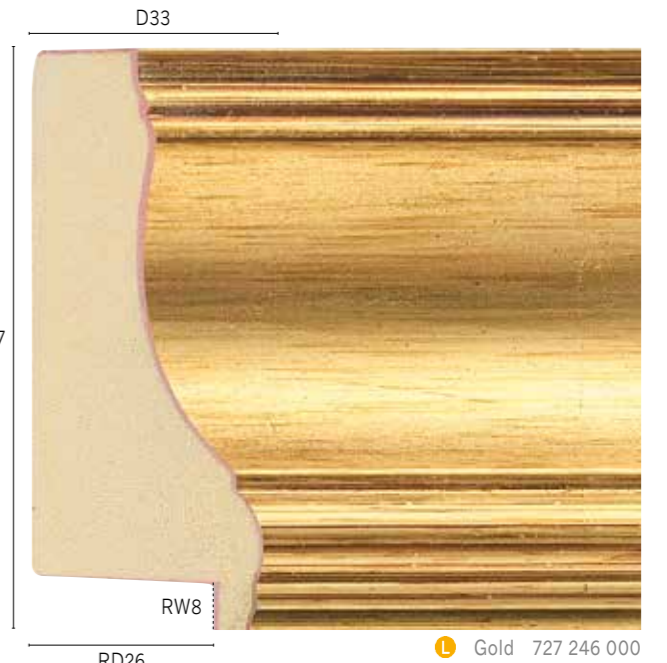
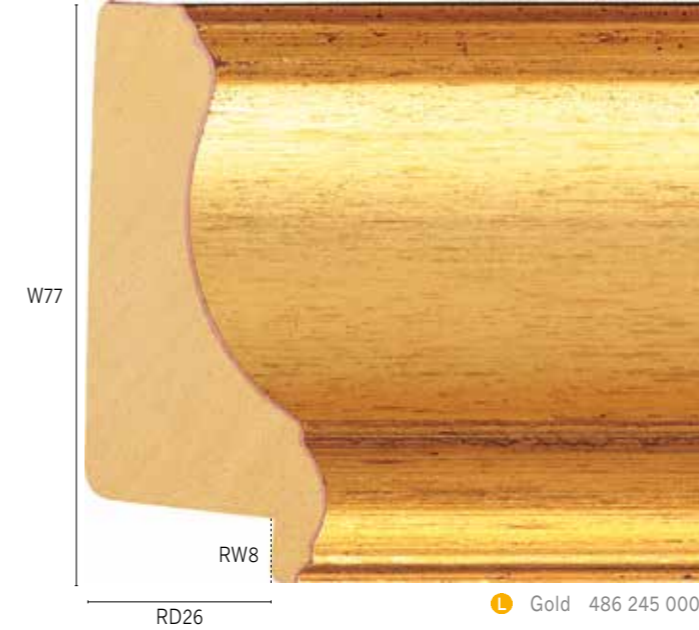
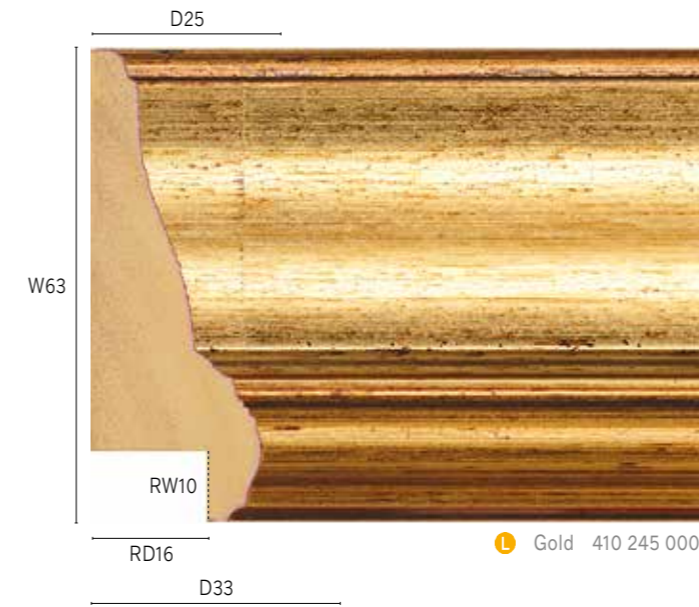
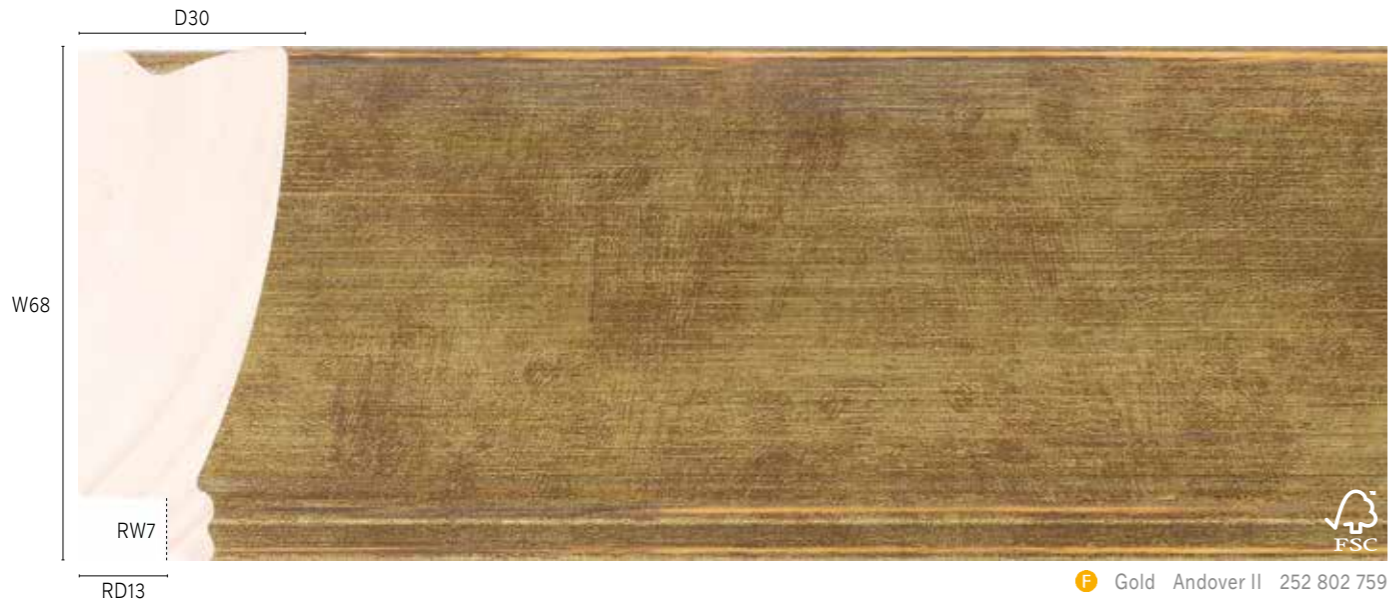





Decorative Gold

Decorative Gold



Timeless and luxurious, gold is always in fashion and brings a sophistication to a wide range of framing projects.

We offer an ornate range of mouldings in an array of widths from a small bamboo to impressive large decorative golds.

Moulding used

630 247 000



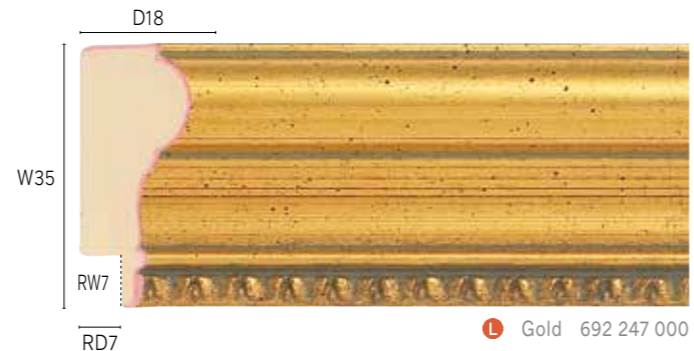
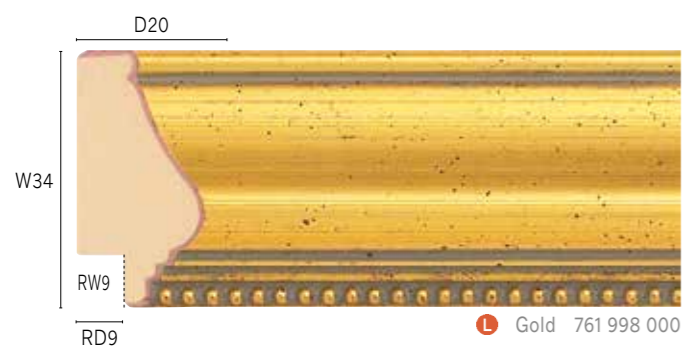

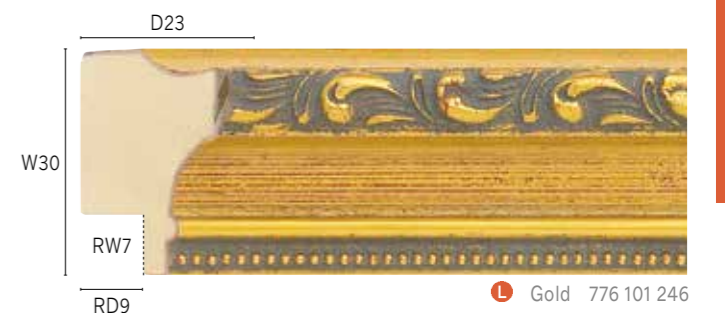
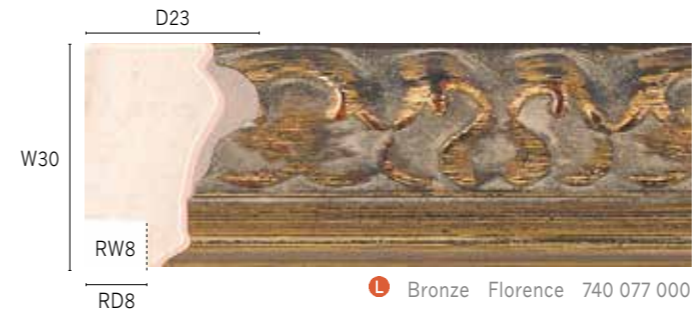

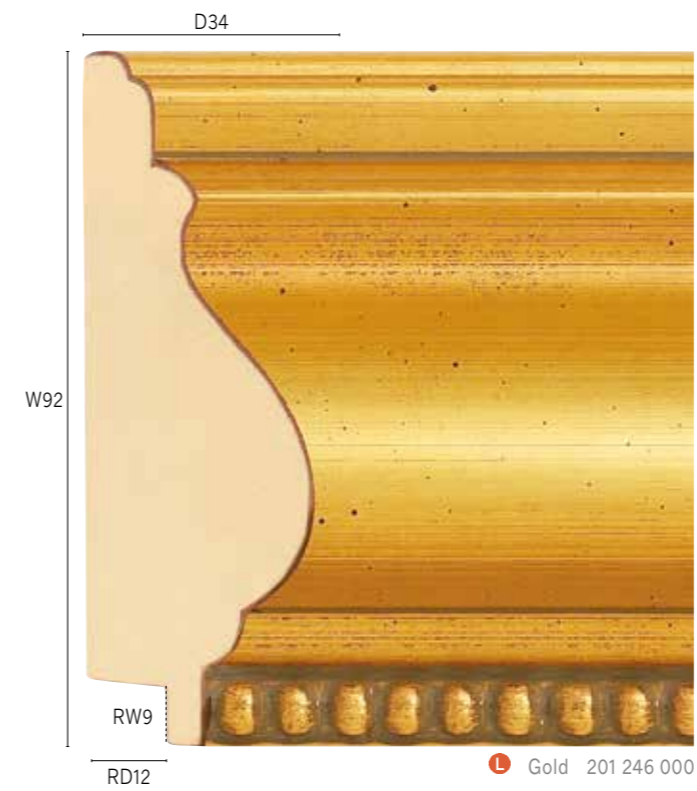
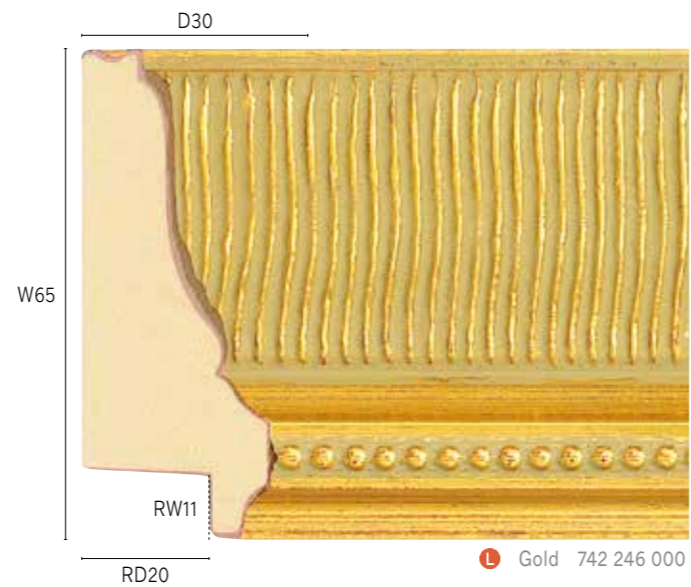
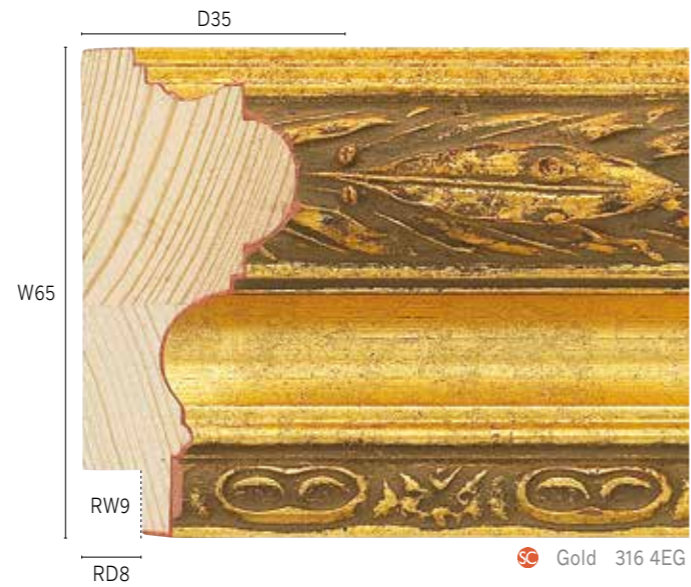
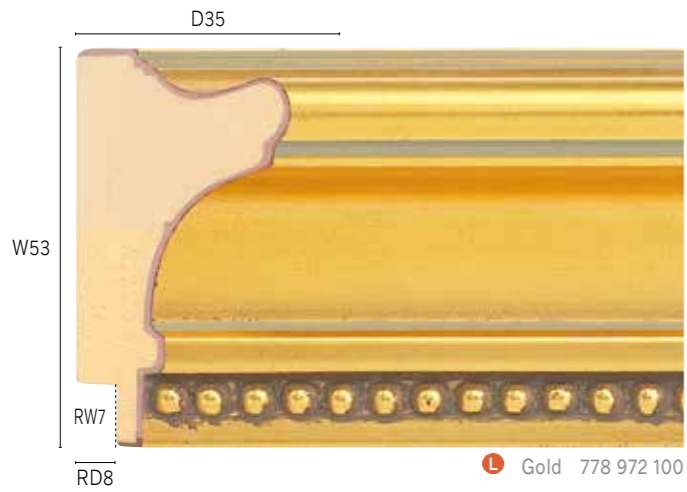

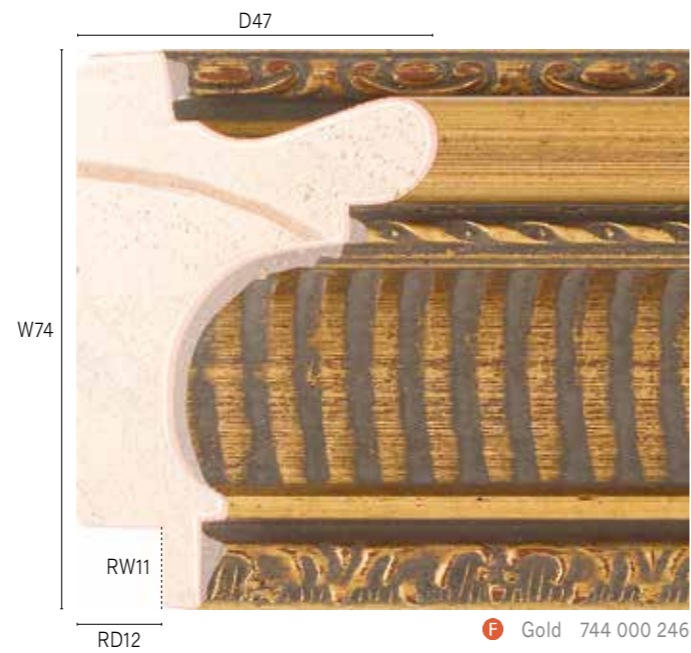
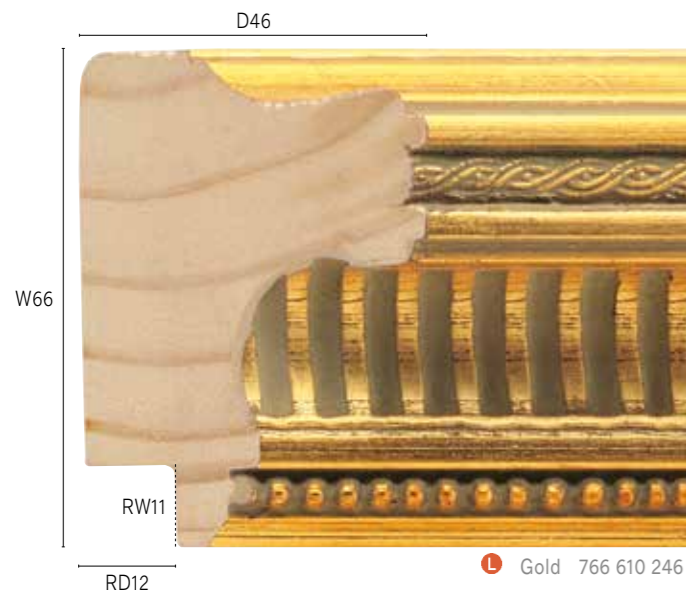
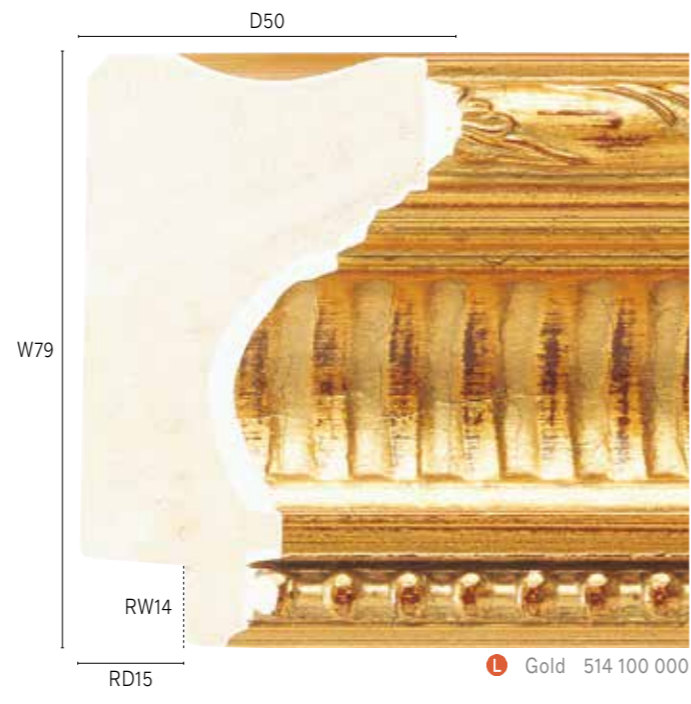



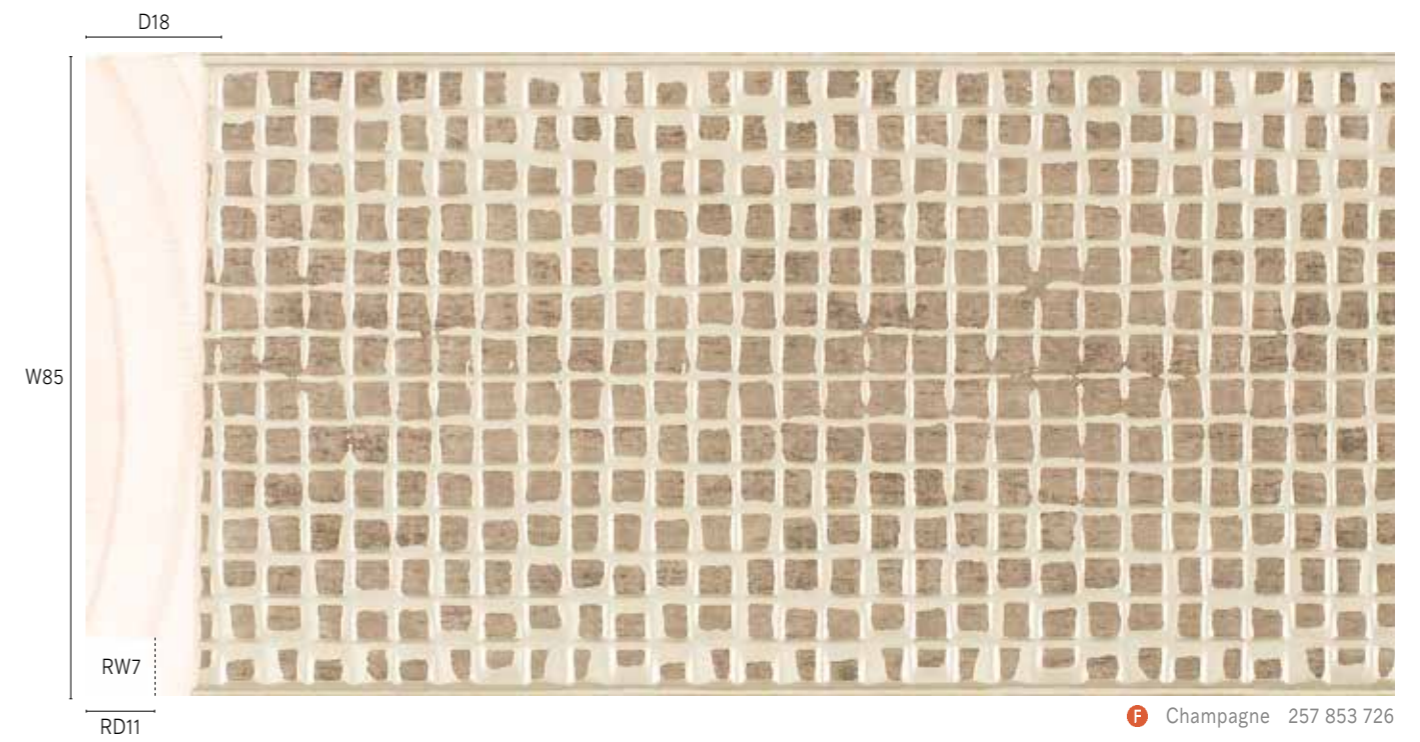

Silver

Silver tones can be cool and sophisticated and give either a modern or vintage look and feel to framing projects.

We offer a variety of silver ranges in an array of contemporary and ornate profiles.



Moulding used

283 502 653

Silver

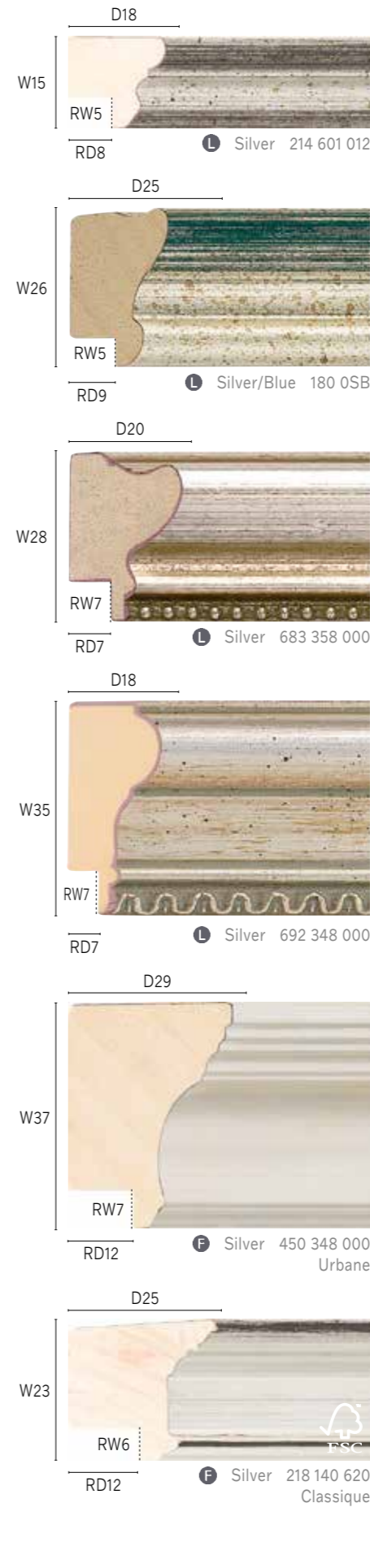

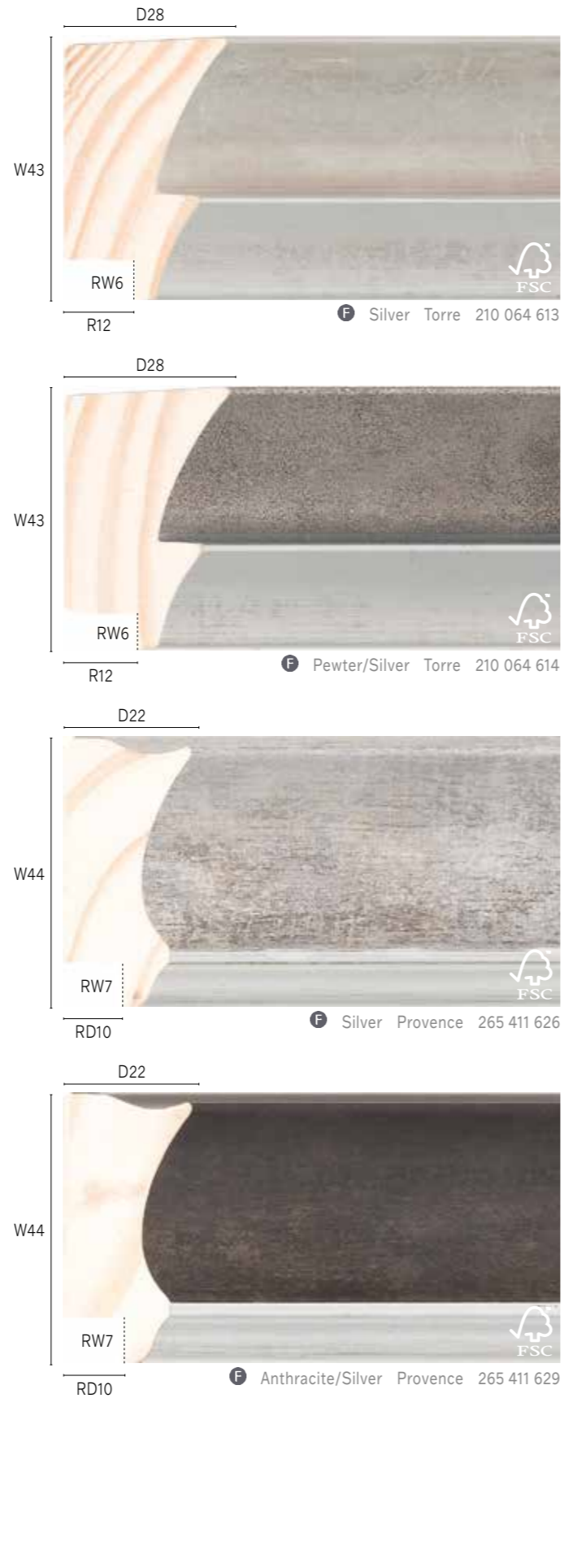
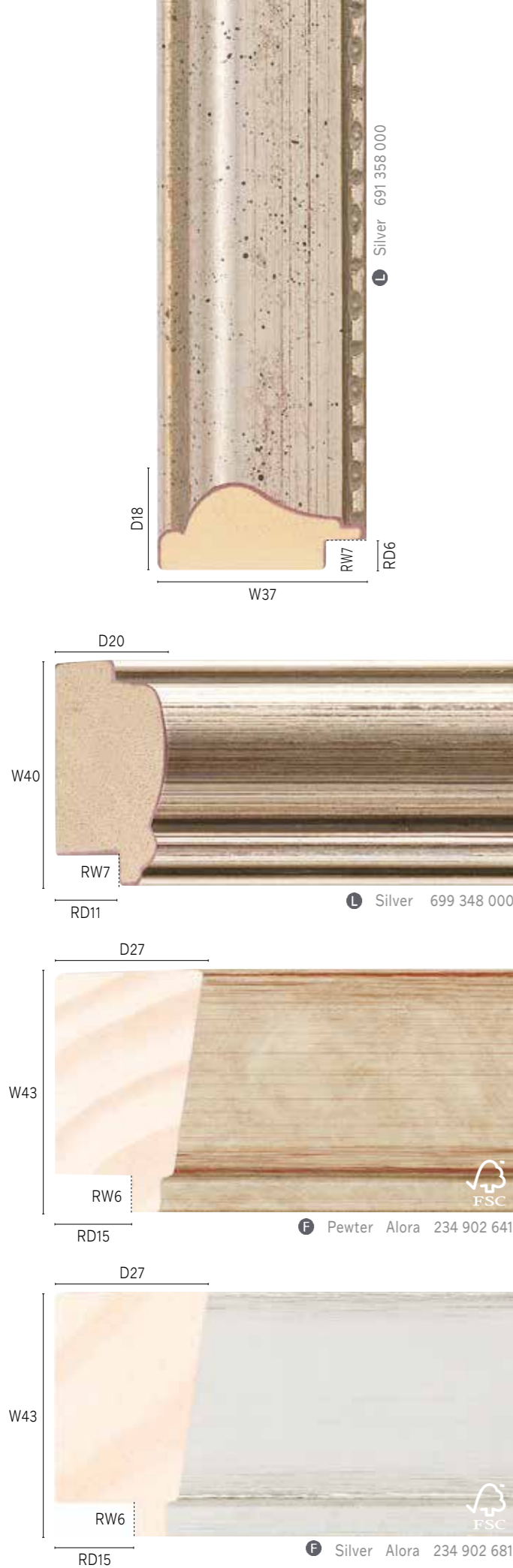



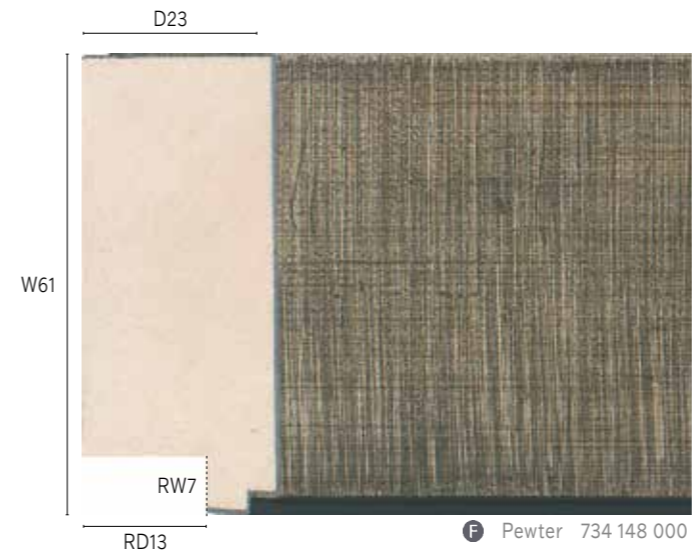

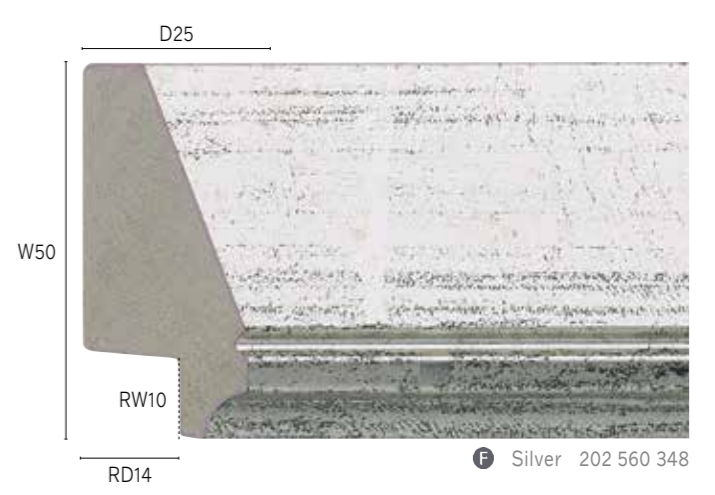
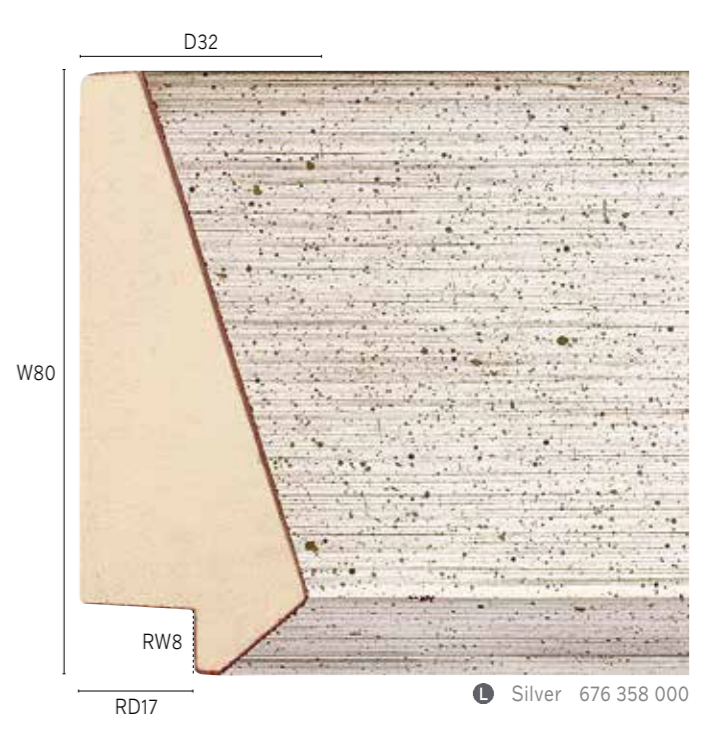
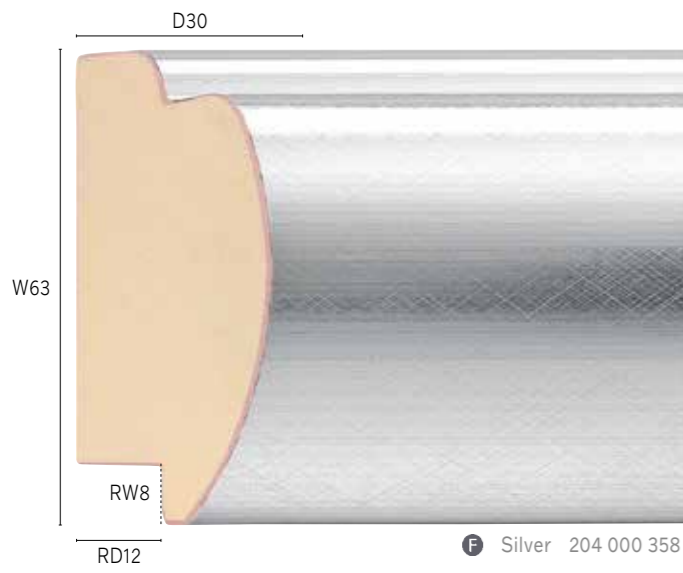
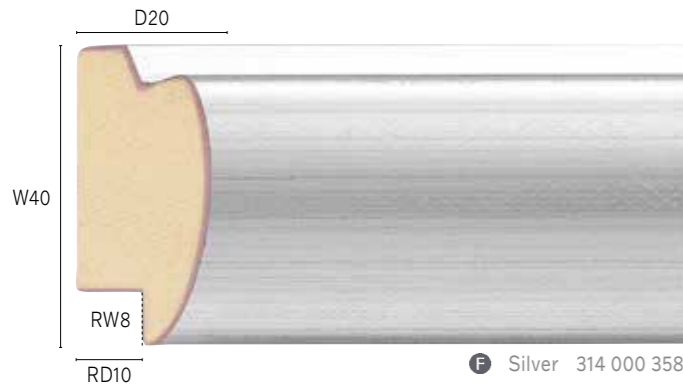

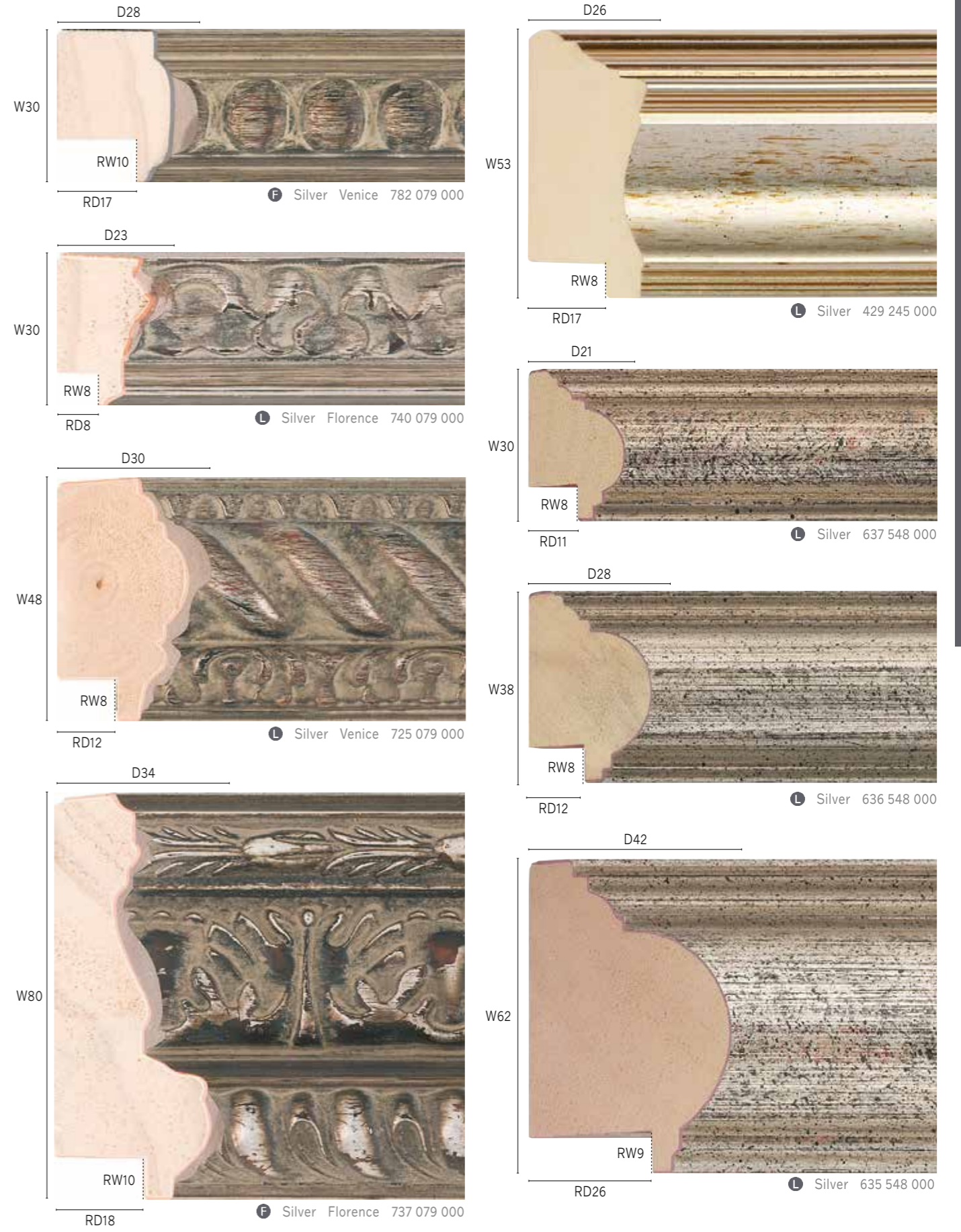
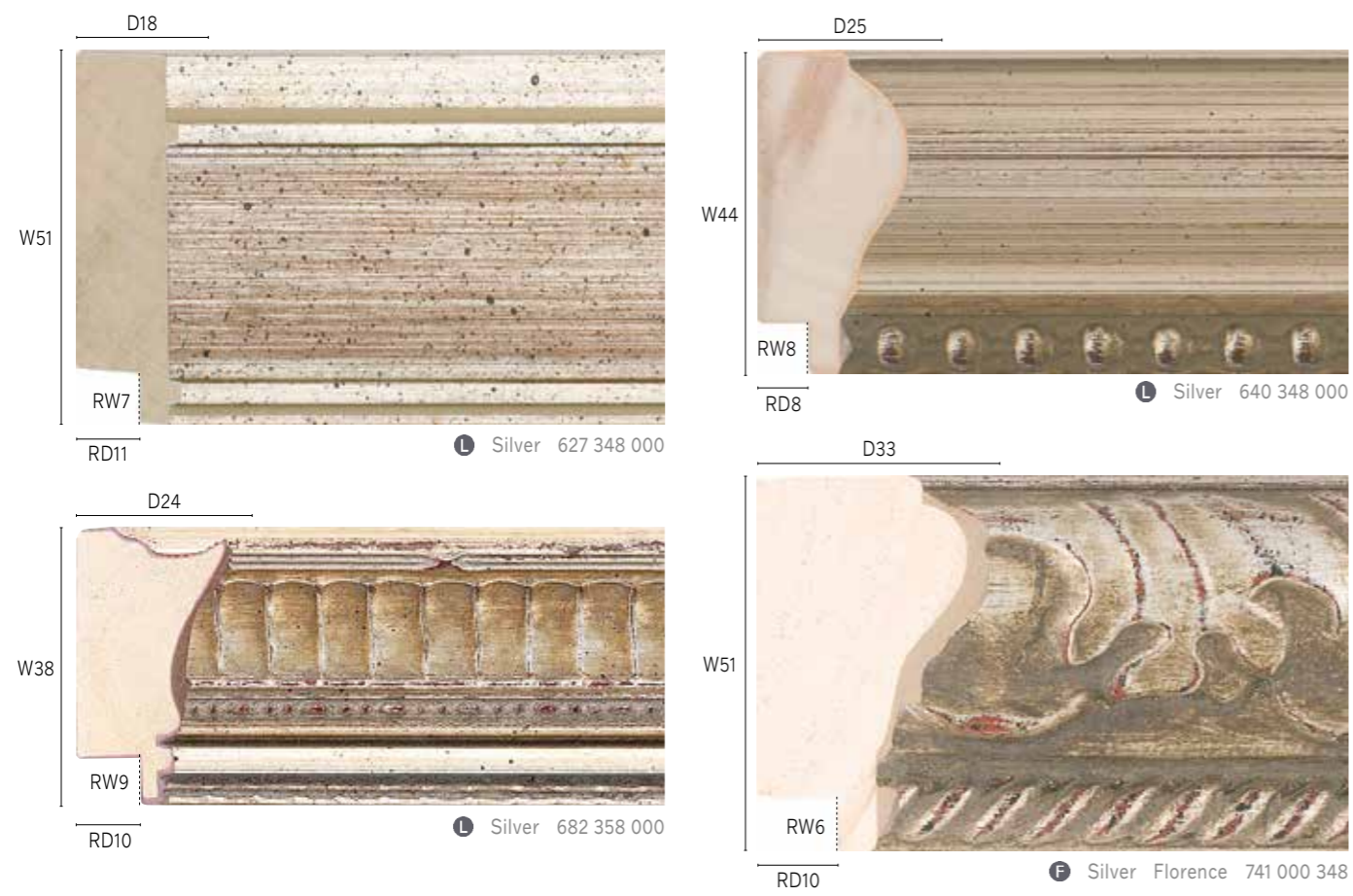

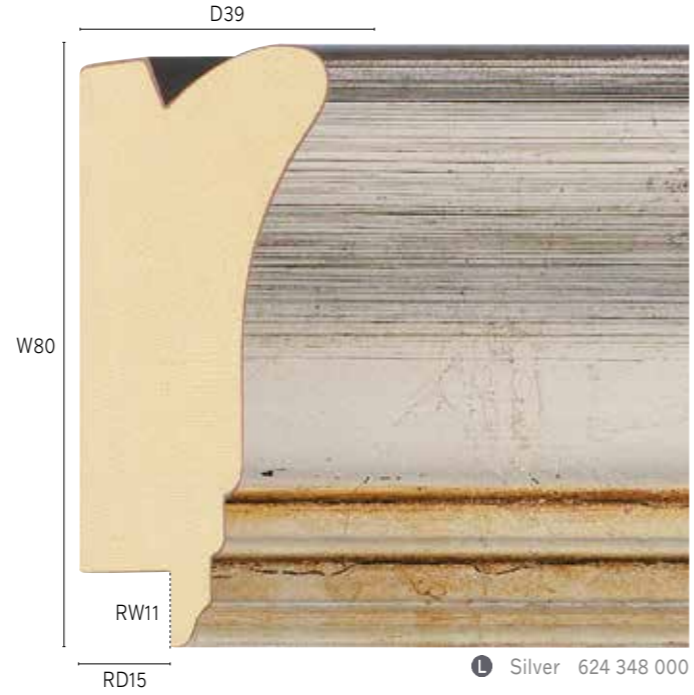

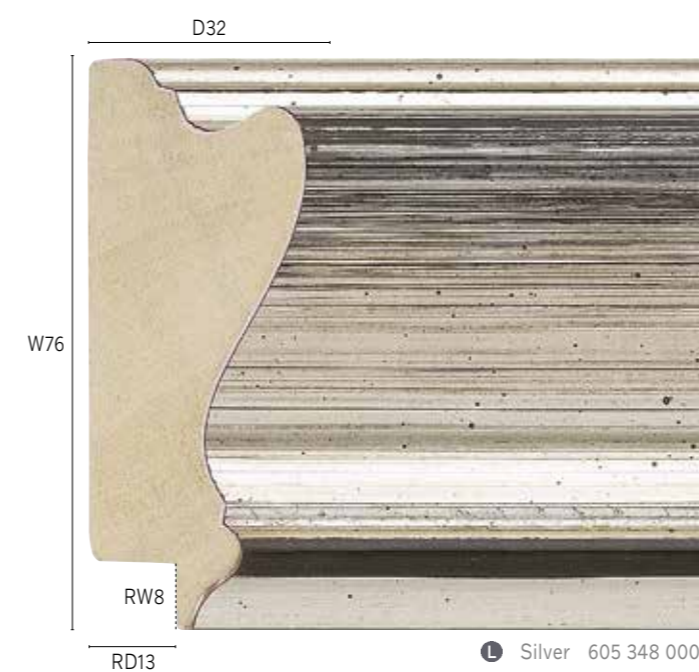
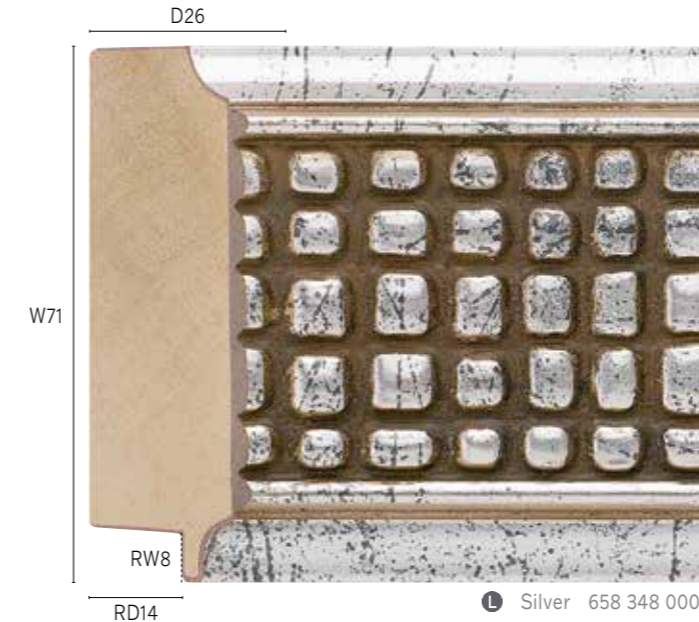
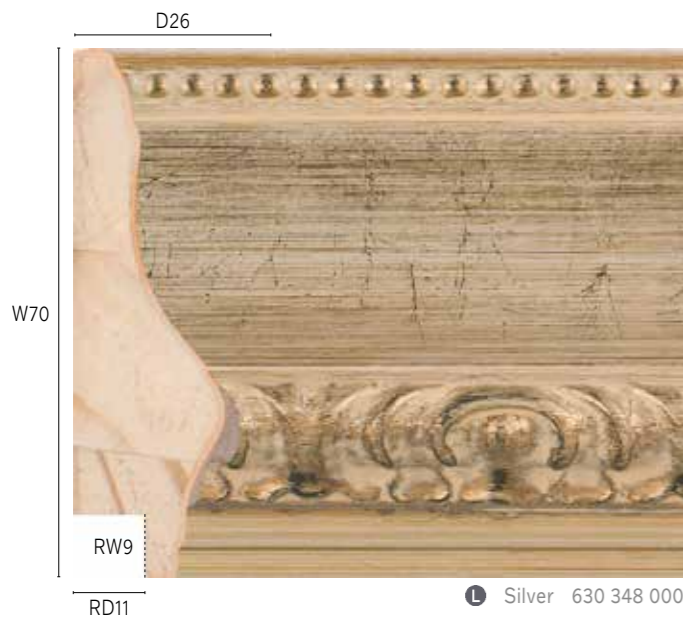

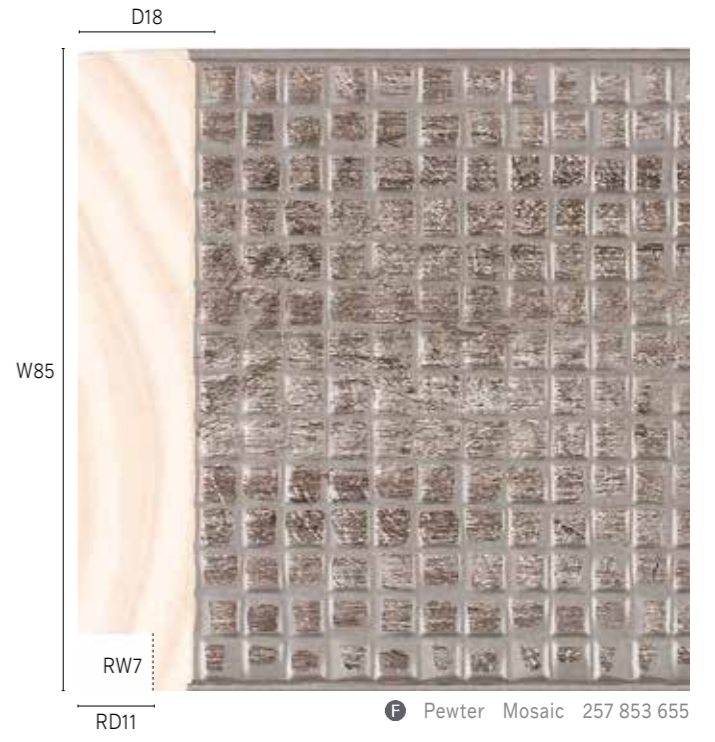
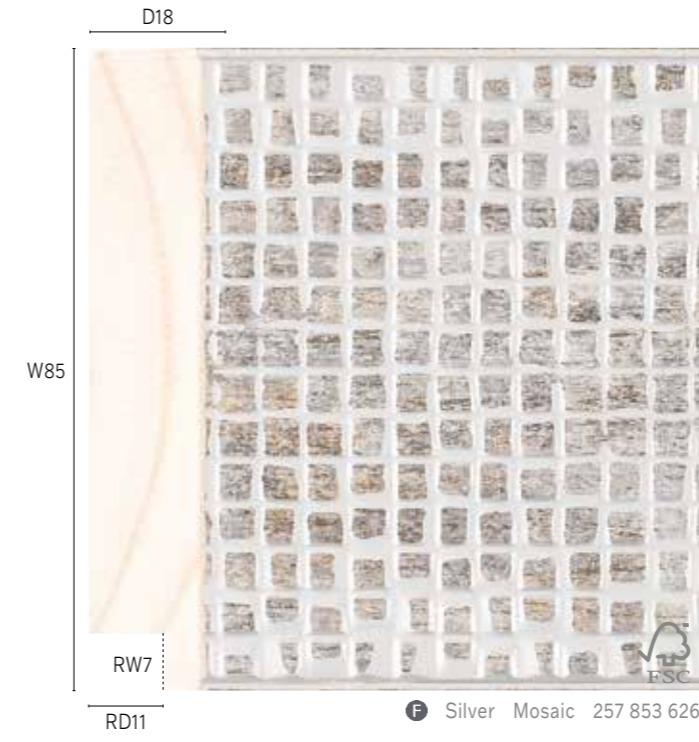
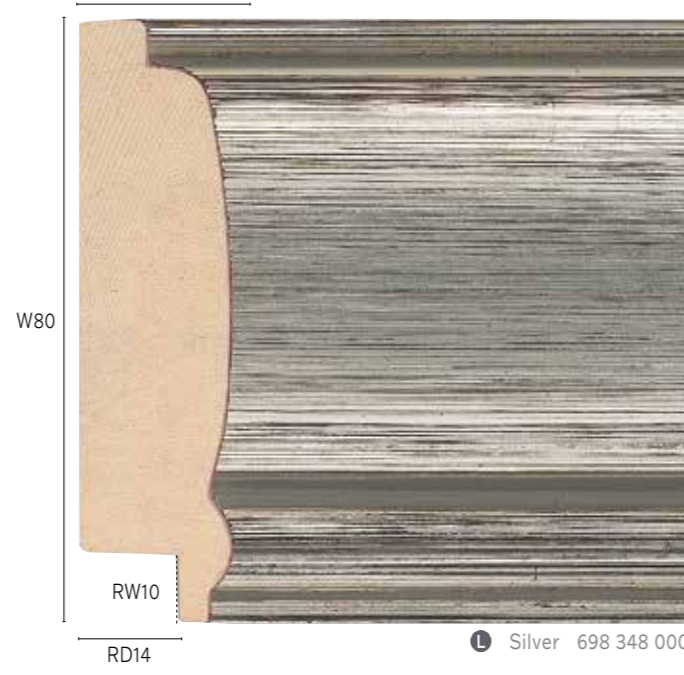
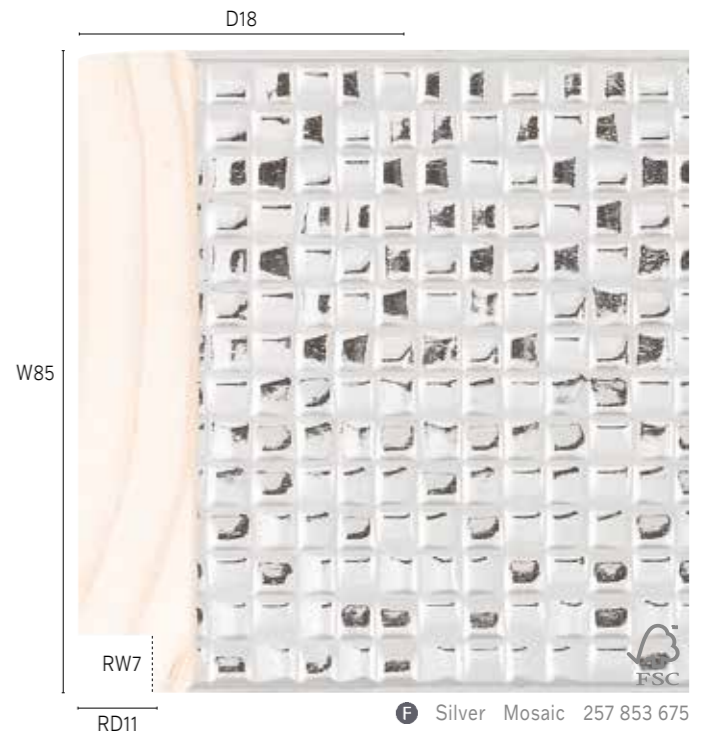

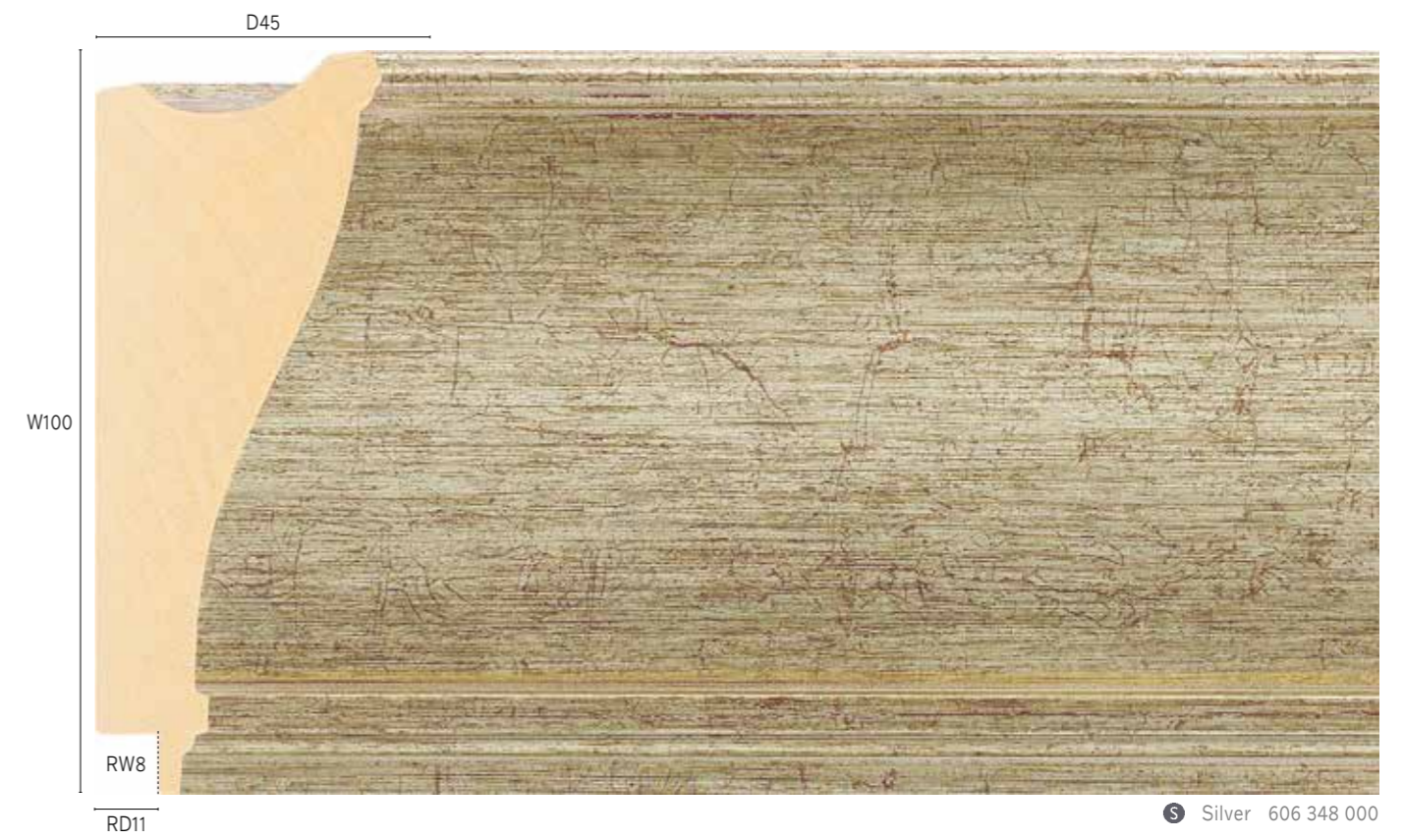
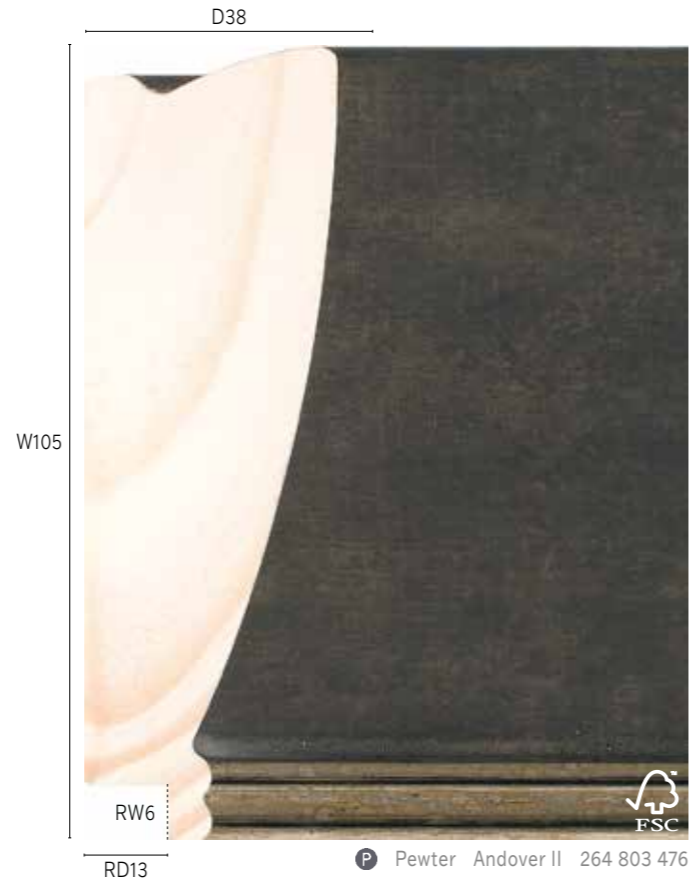
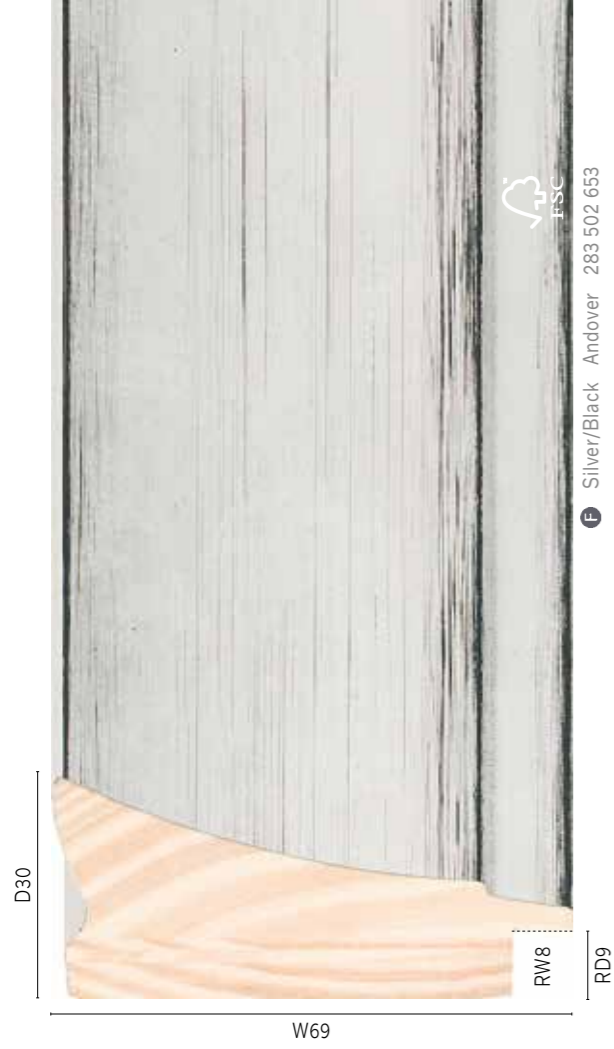

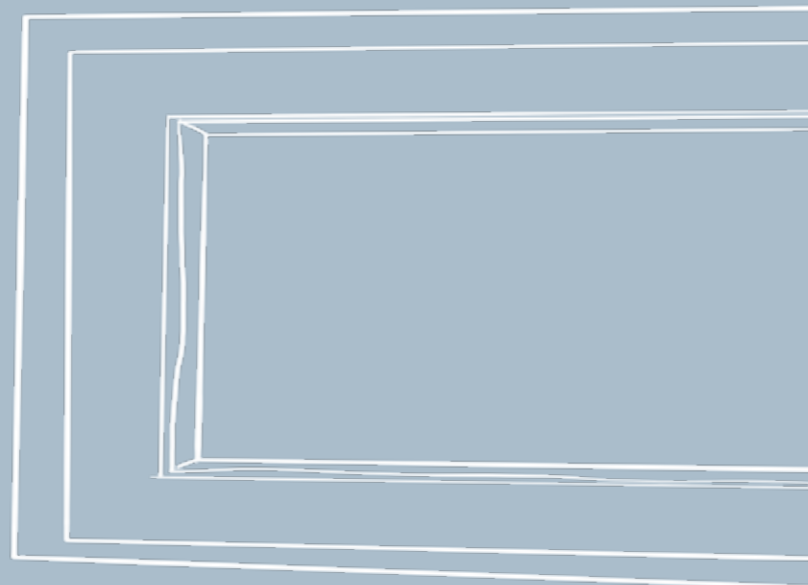

Aluminium Wrapped Wood

Frames made with these mouldings have all the appearance of being made from conventional extruded aluminium, which to most framers would normally mean buying in pre-mitred cut lengths in kit form - a process that can add at least 24 hours to a job.

These mouldings have the advantage of being constructed with a thin aluminium skin wrapped on wood, which means that mitres can be cut on a Morsø machine or circular saw and frames are then finished in the same way as regular moulding.

The mouldings are supplied protected by a thin plastic film which will prevent any scratches to the aluminium surface during frame construction and is easily removed before collection by the customer.



Moulding used
922 705 000

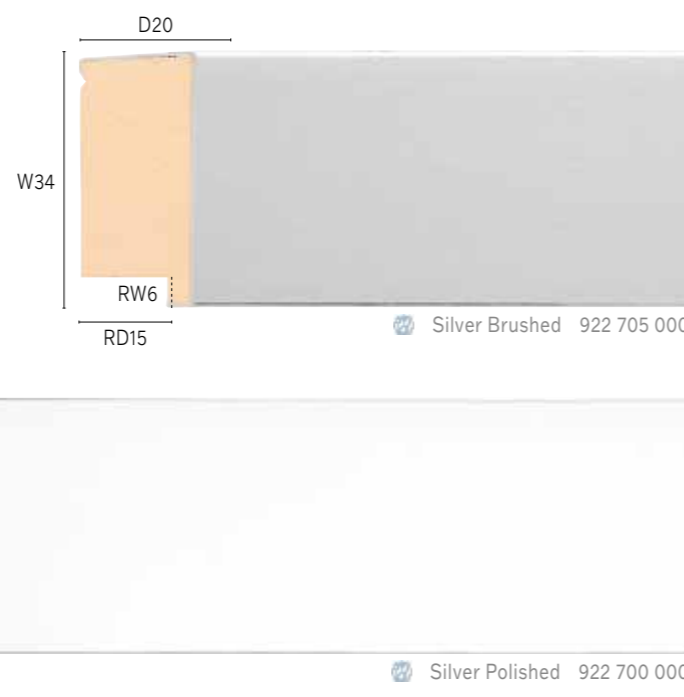
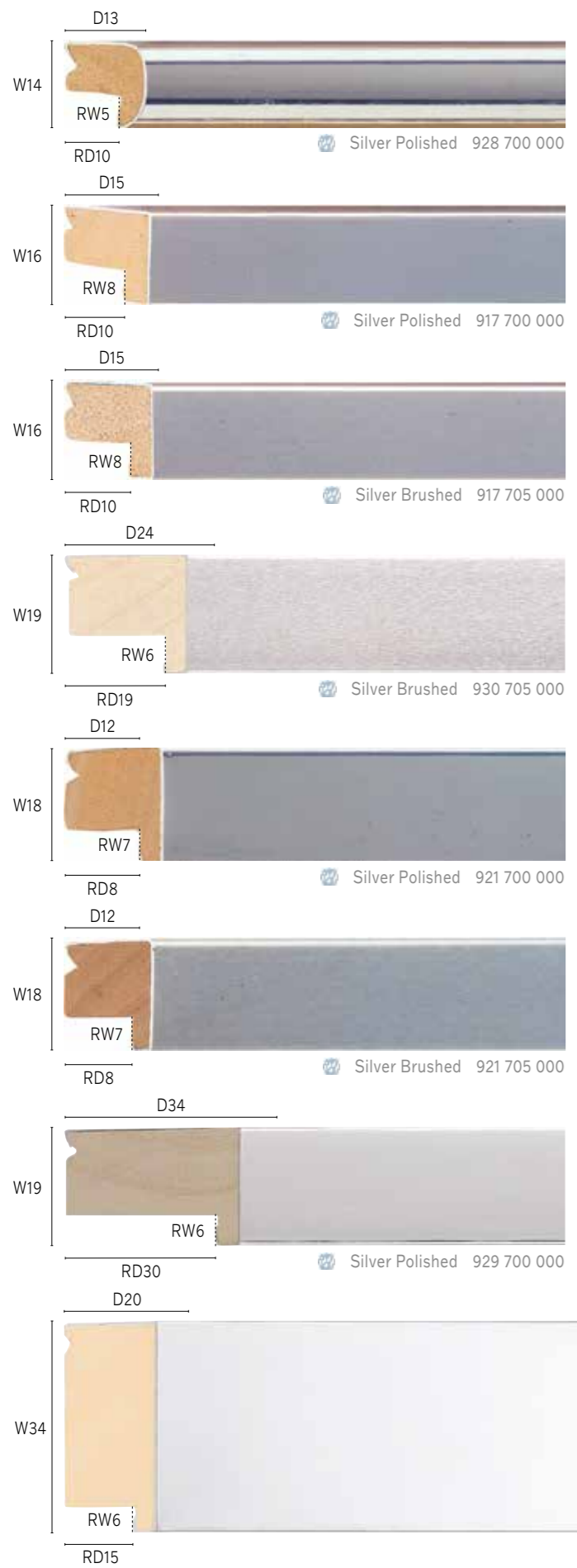

Black

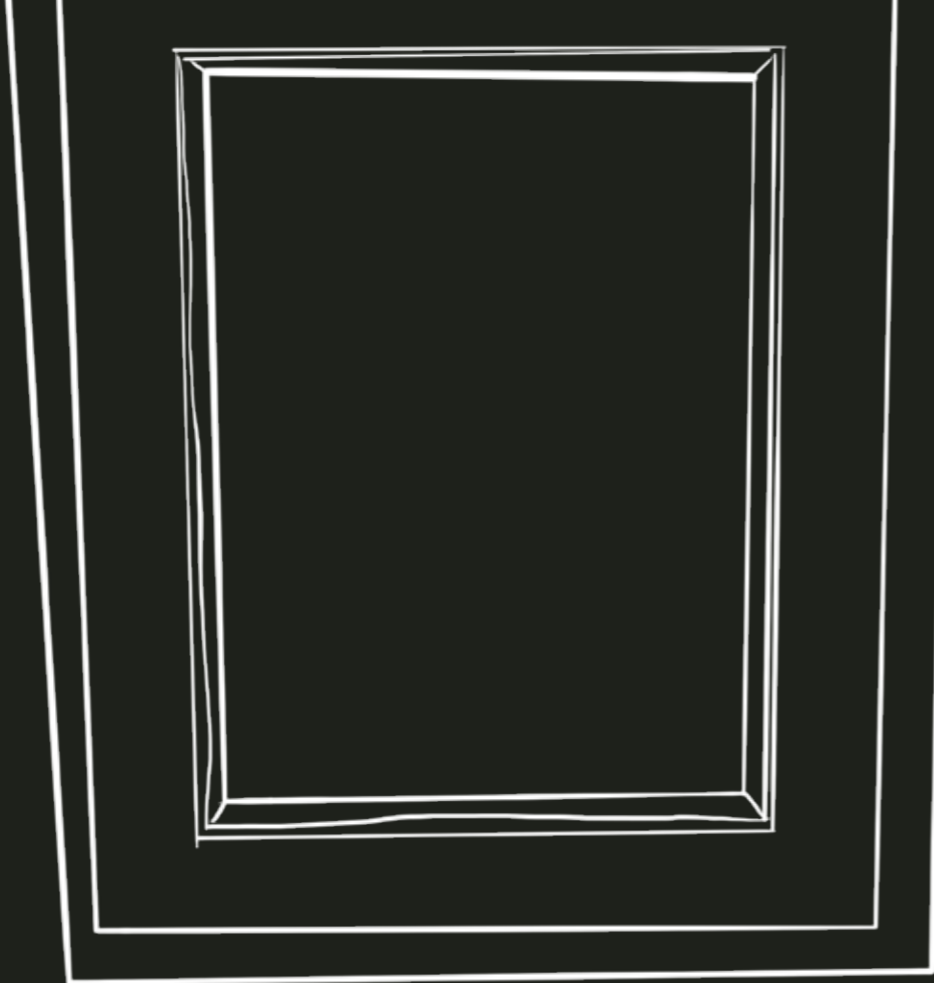

Black

For a confident, bold and timeless look, black remains an excellent choice. At once both classic and contemporary, we have a wide selection of black mouldings including foil finishes for Simplicity and the impressive Hampshire range.



Moulding used
432 167 348

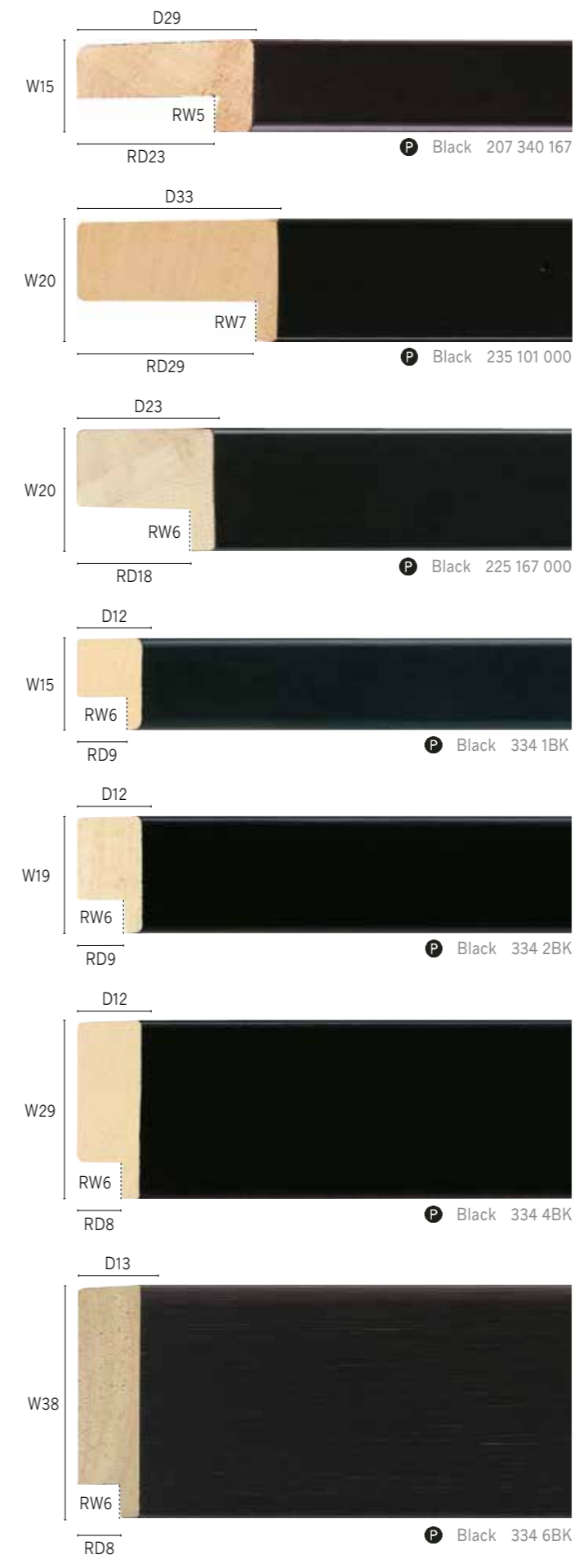
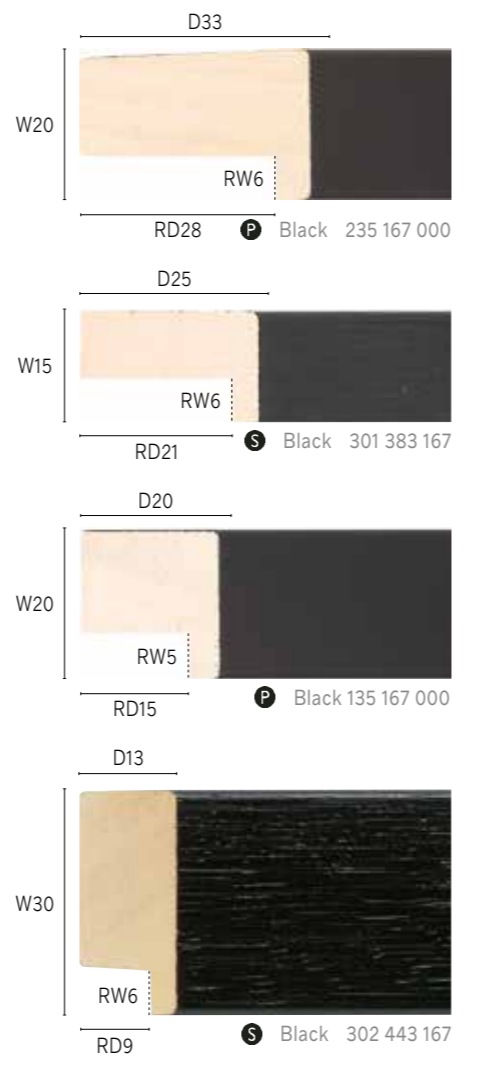
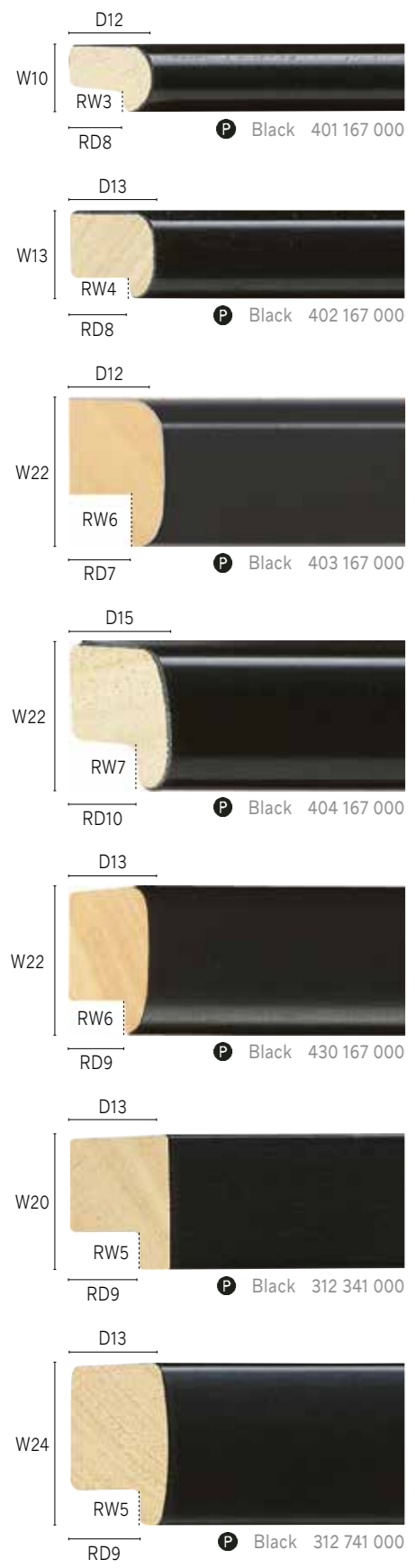

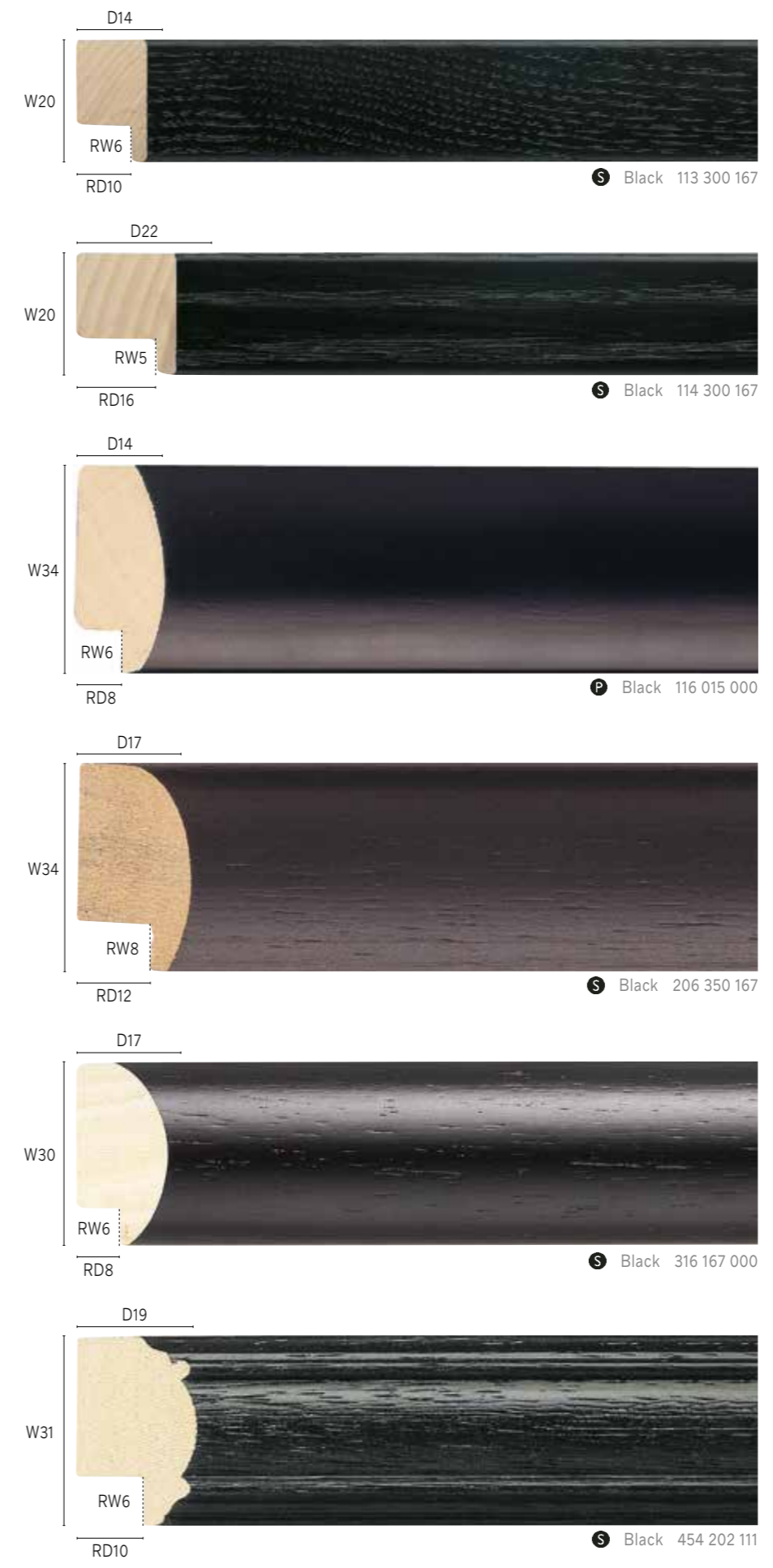
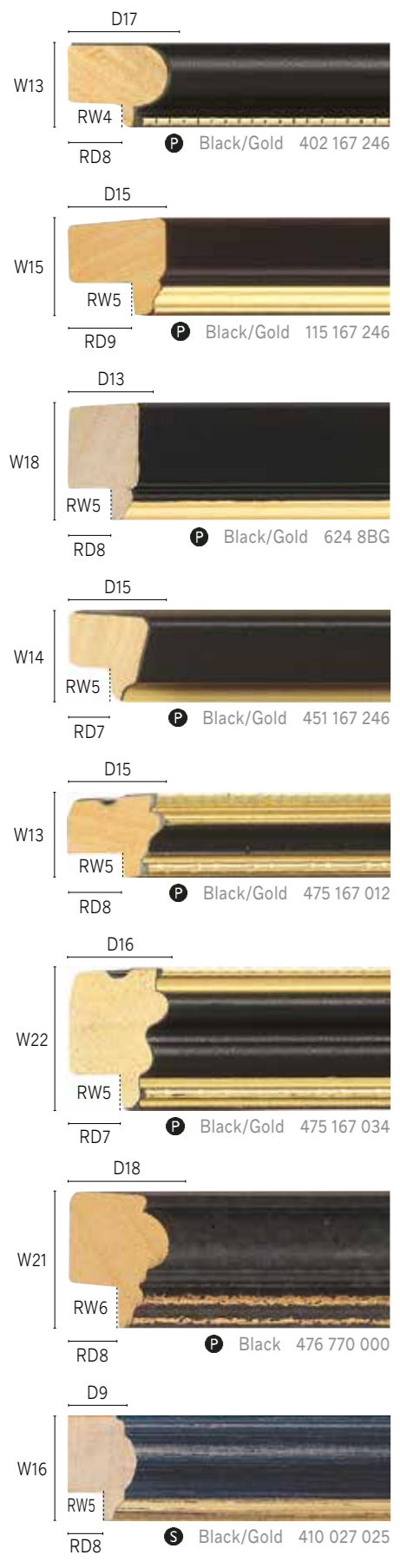

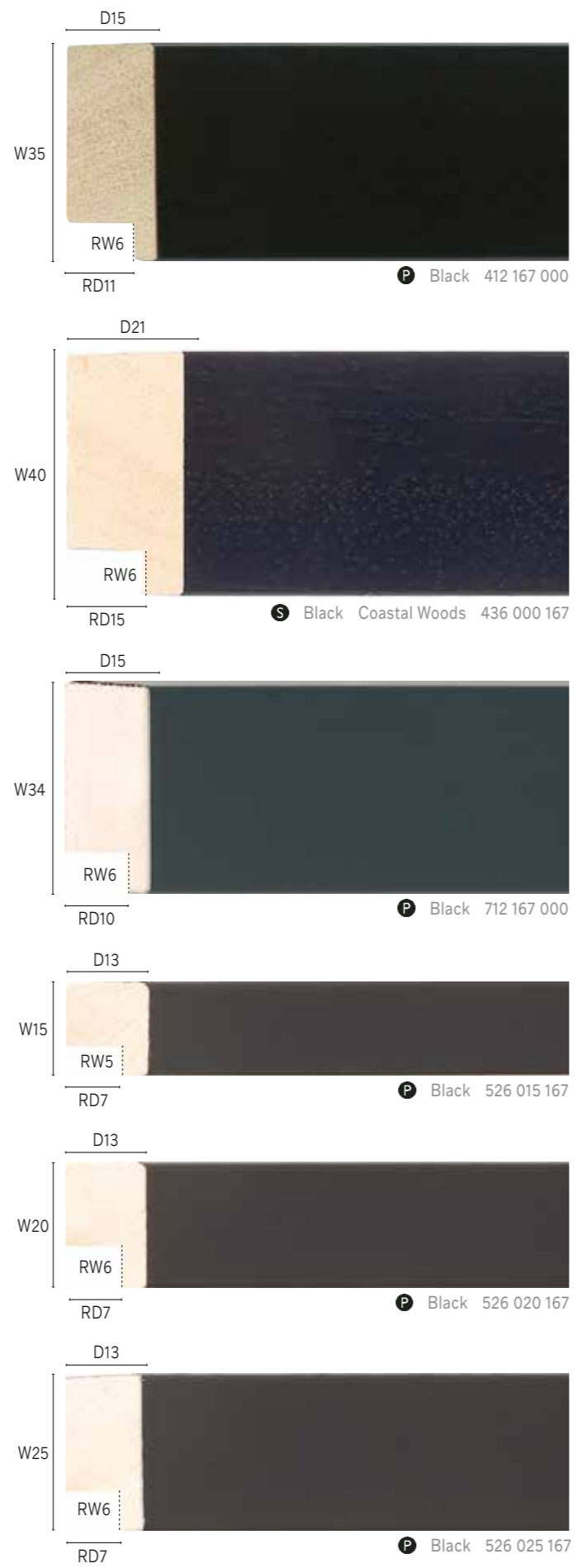
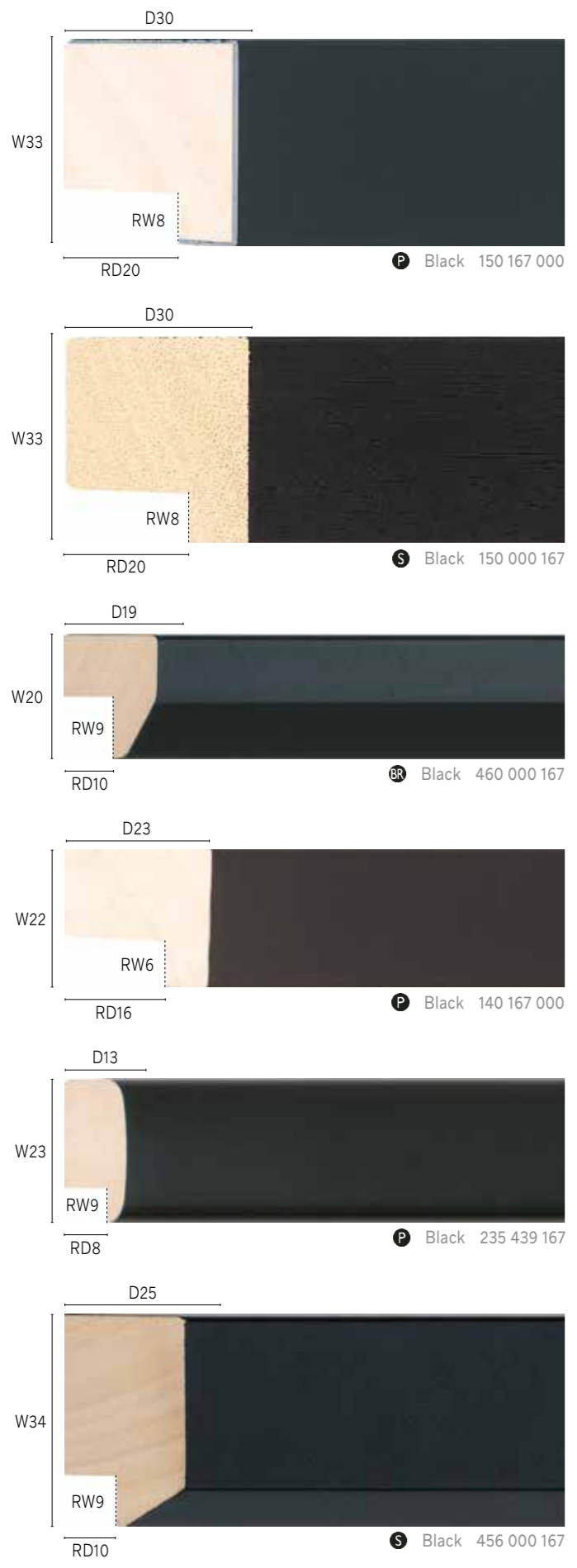

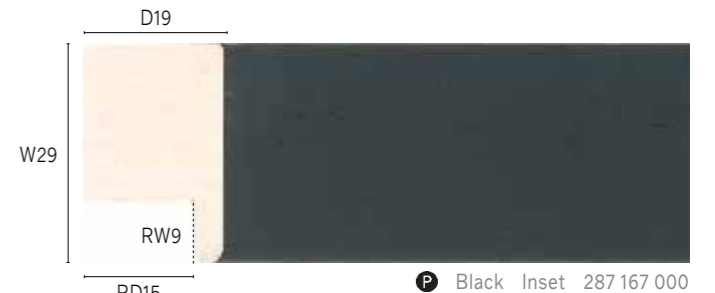
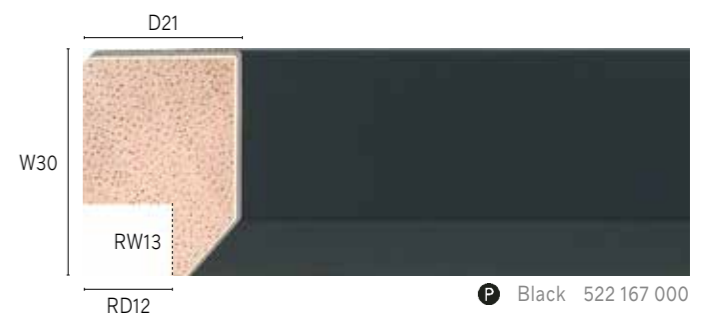
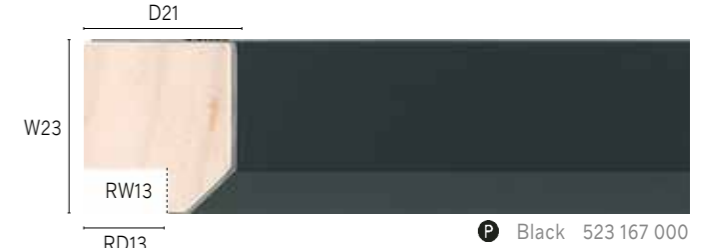
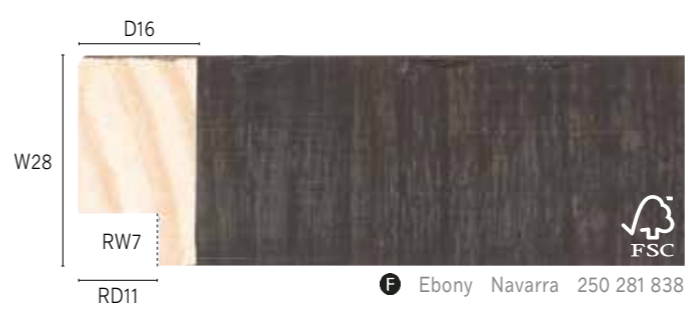

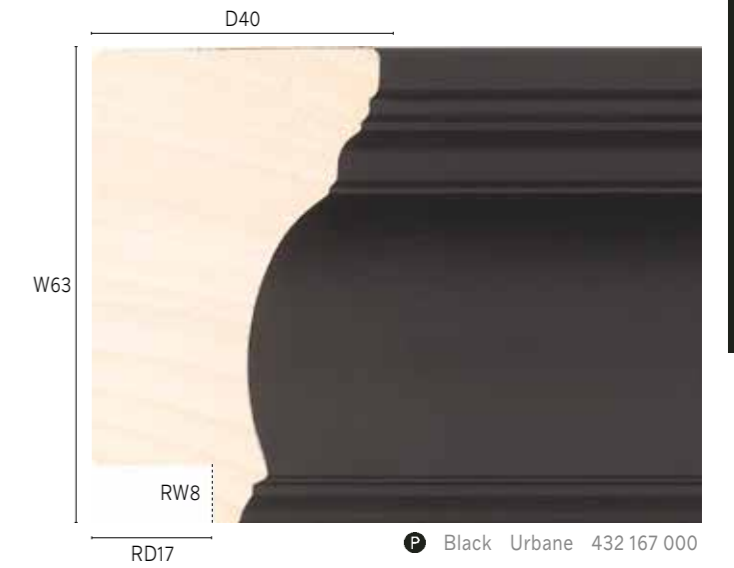
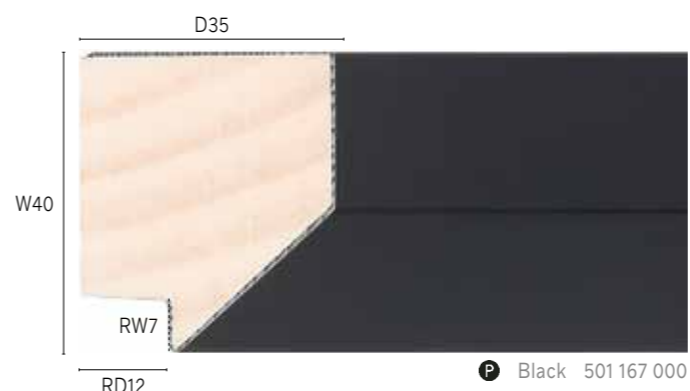
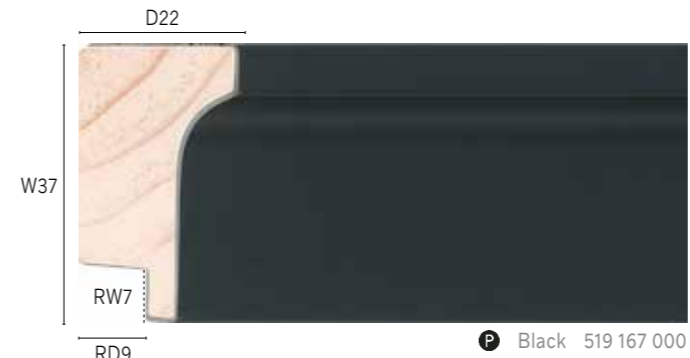

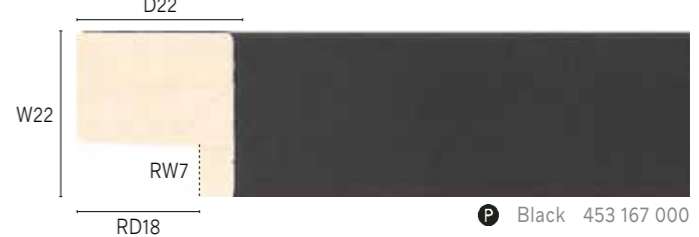
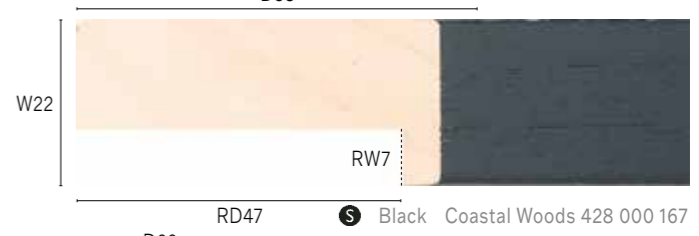
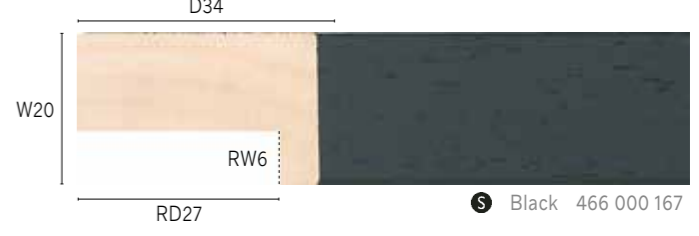
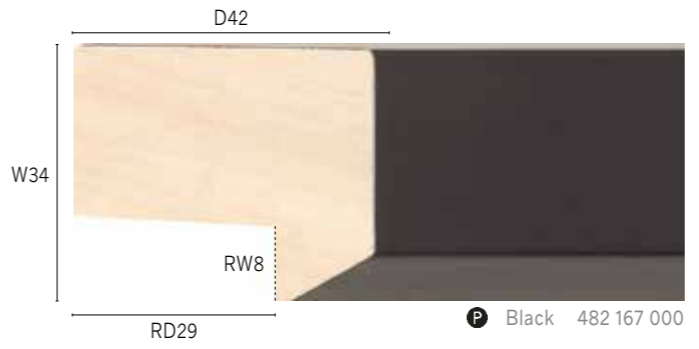

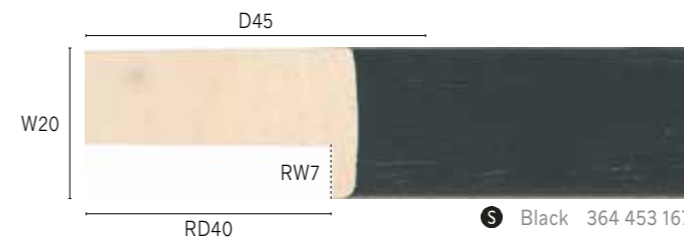
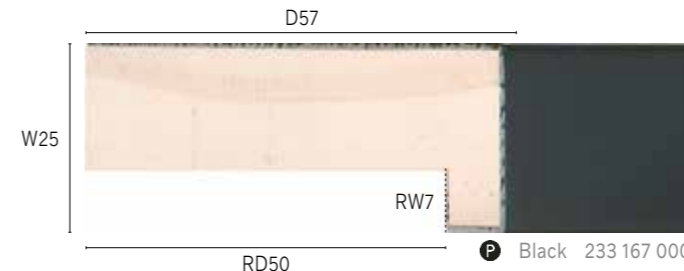
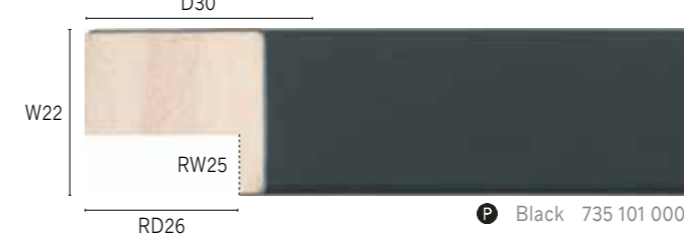
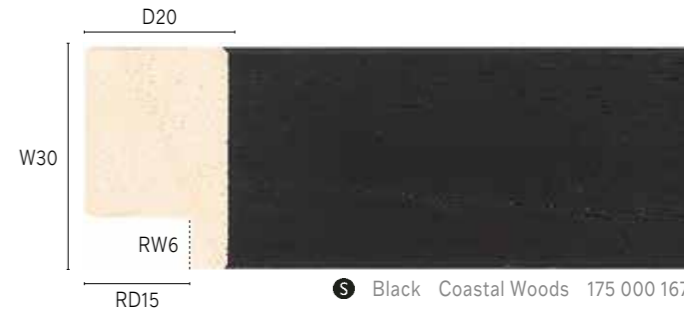
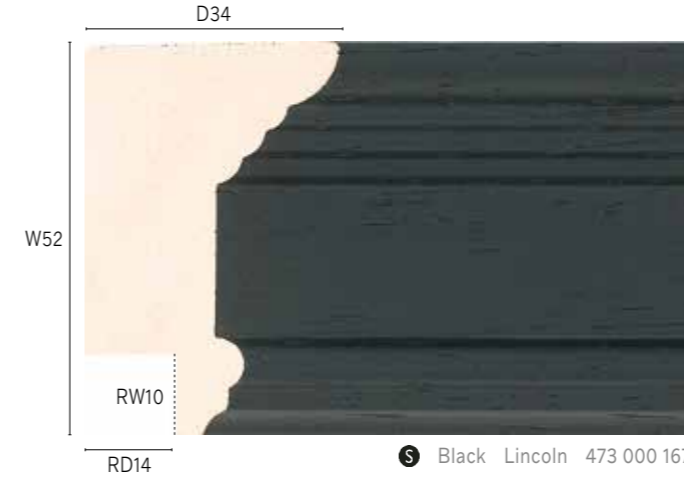
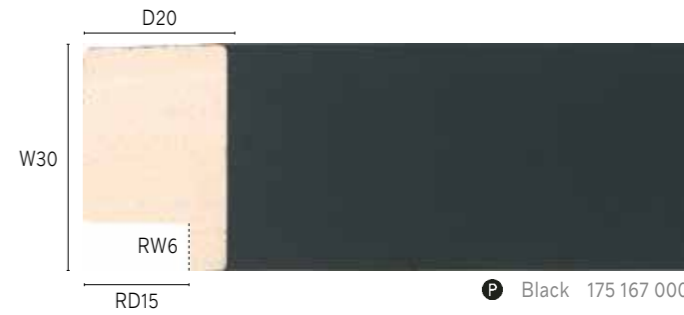
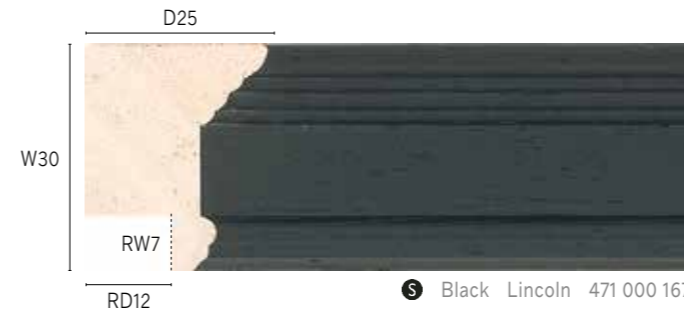
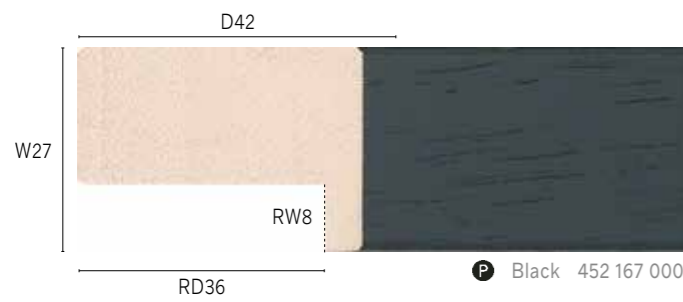
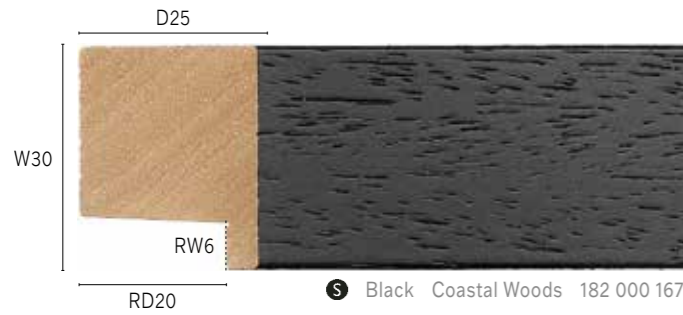

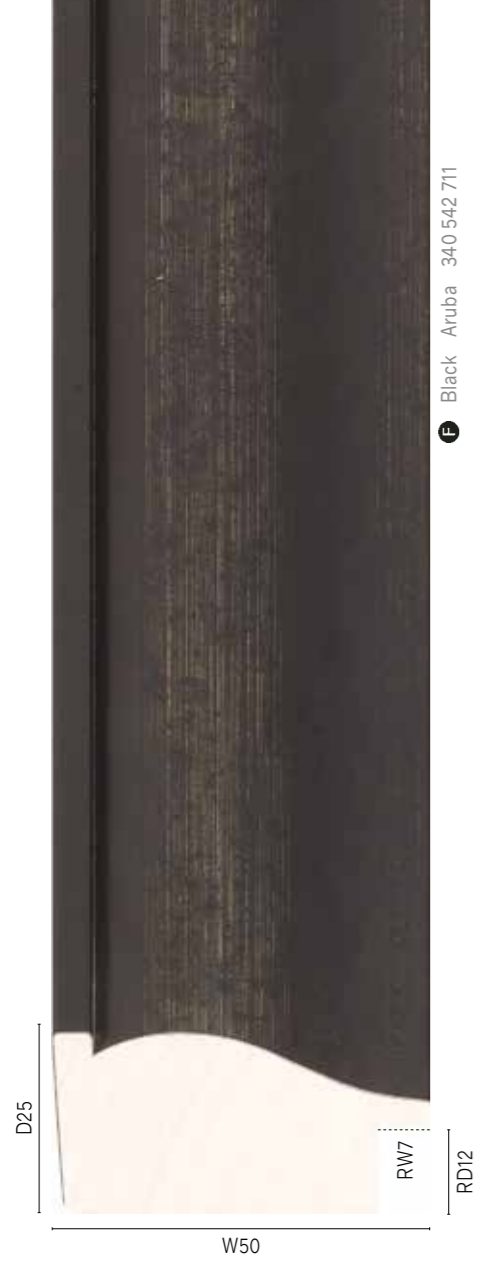

Black Aruba 340 542 711

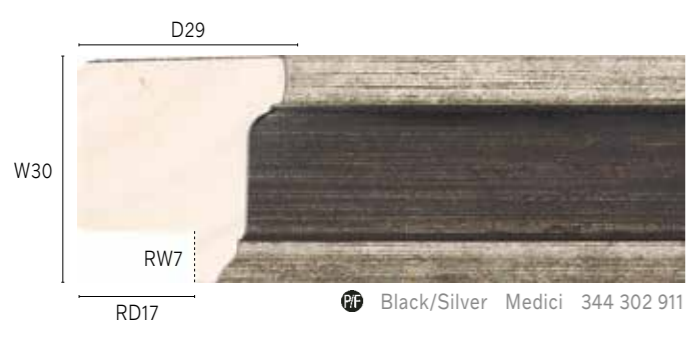
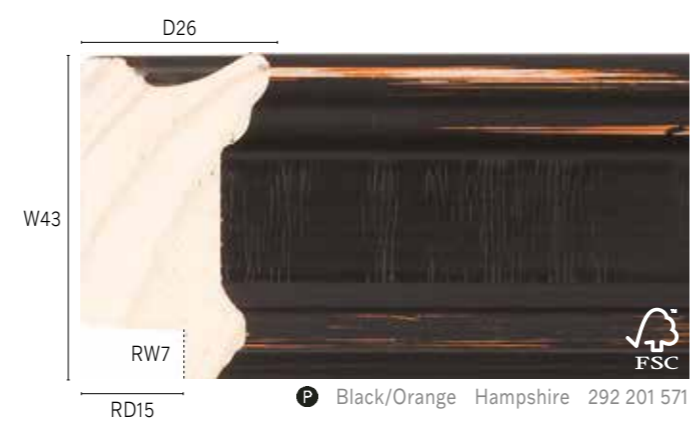
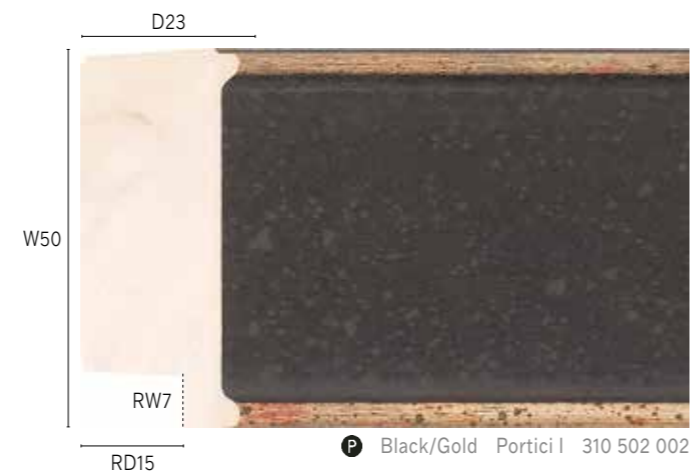

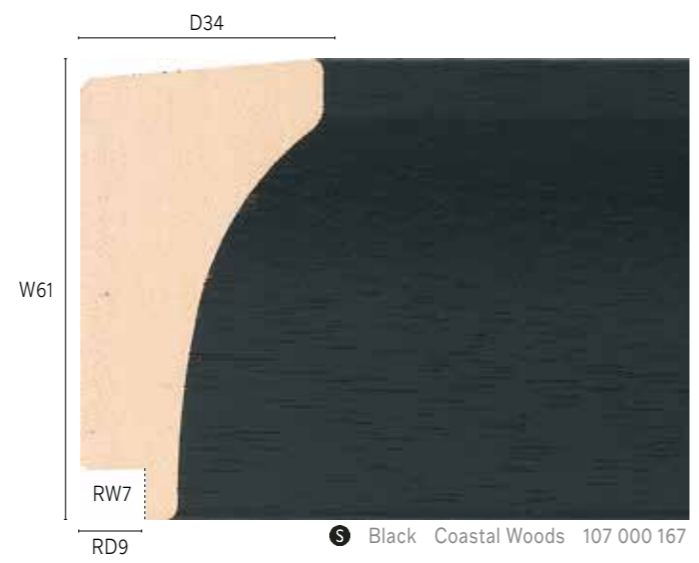
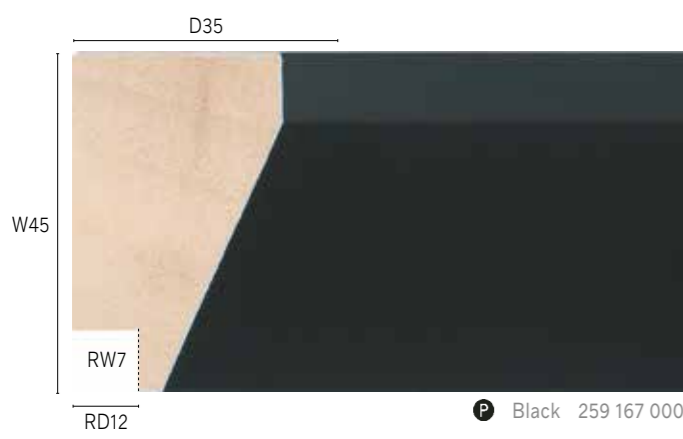
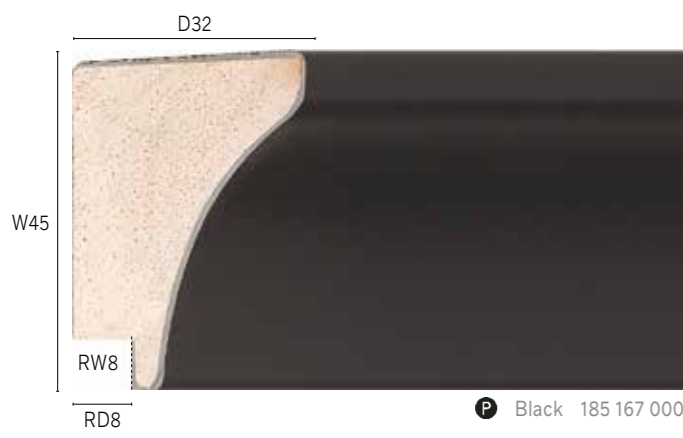
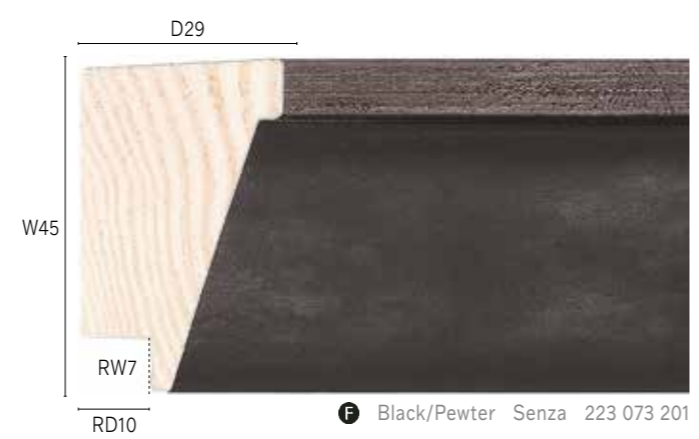
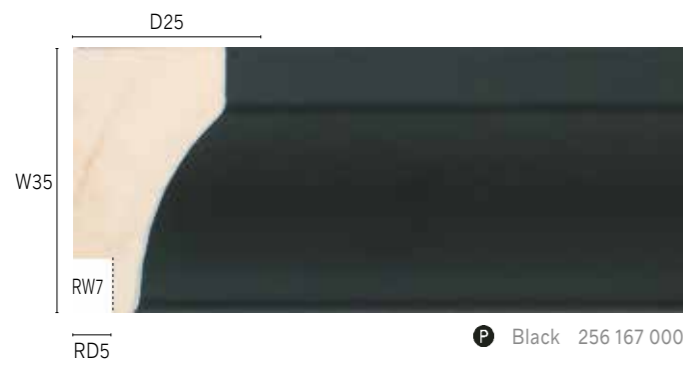

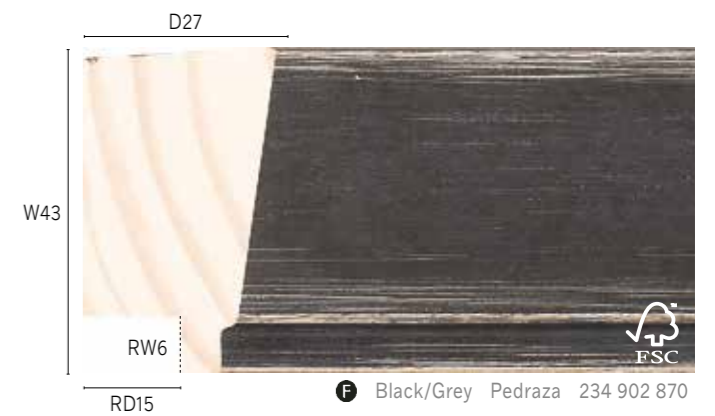
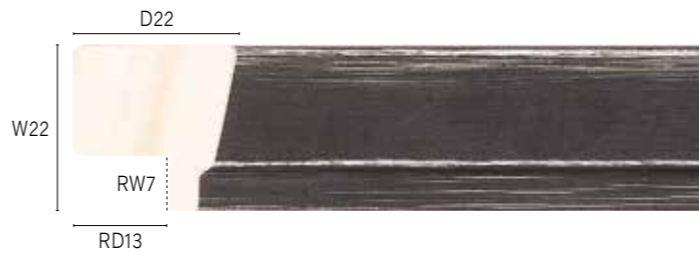
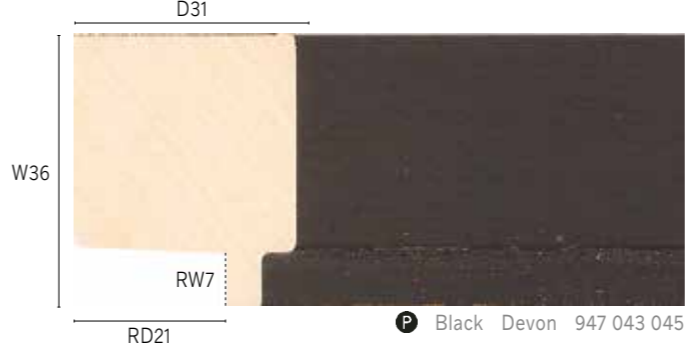
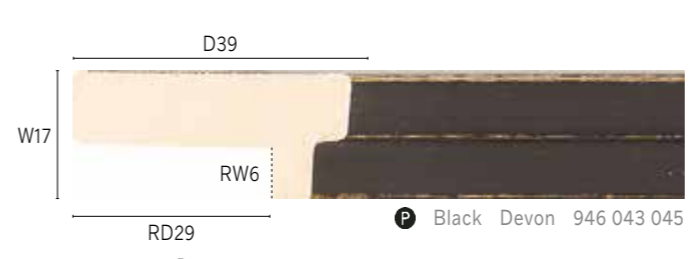
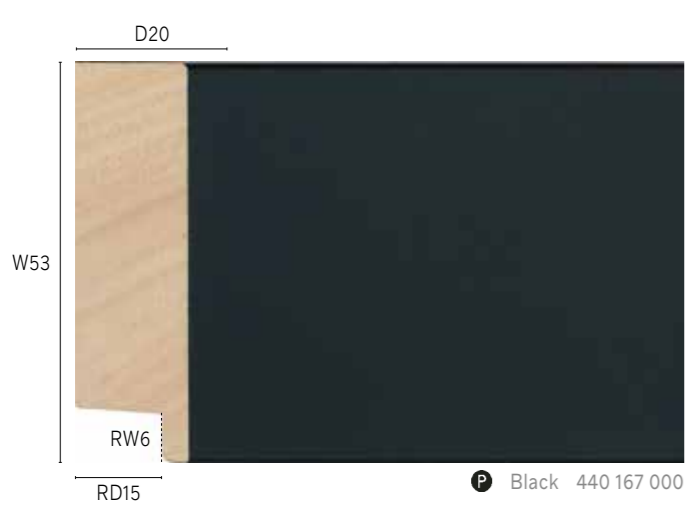
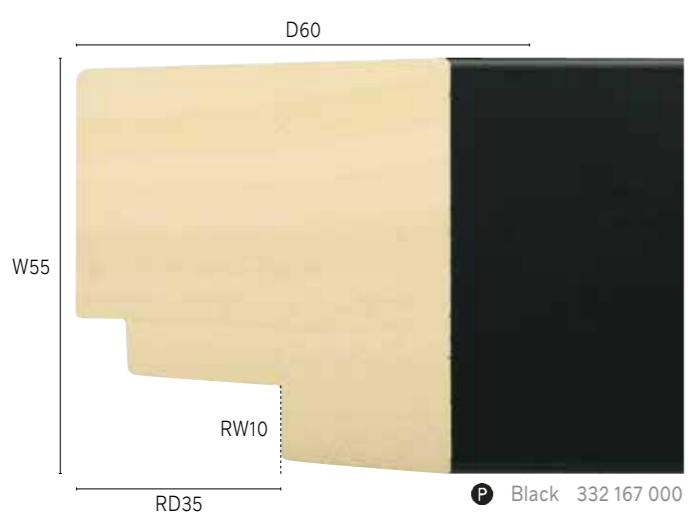
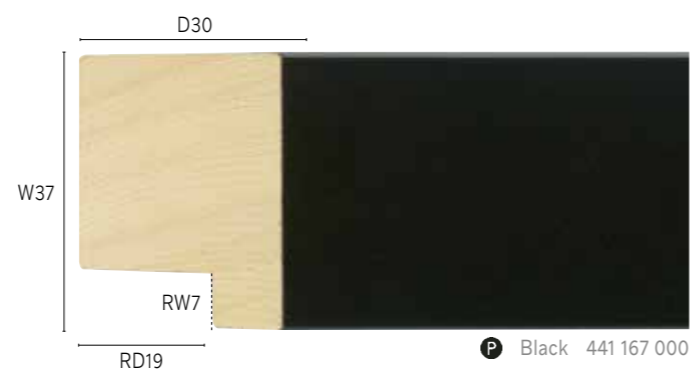
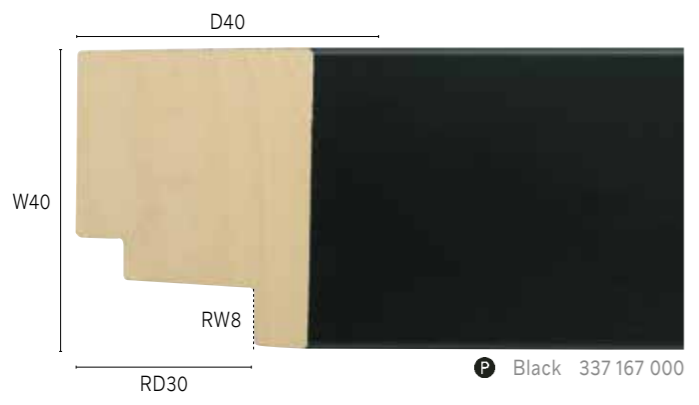

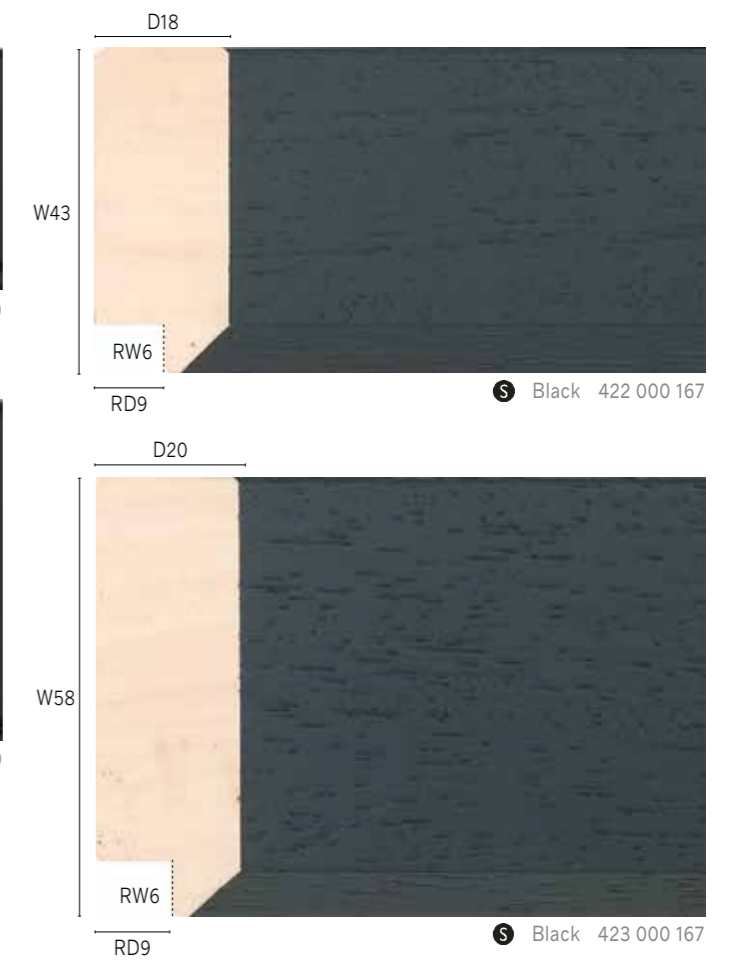
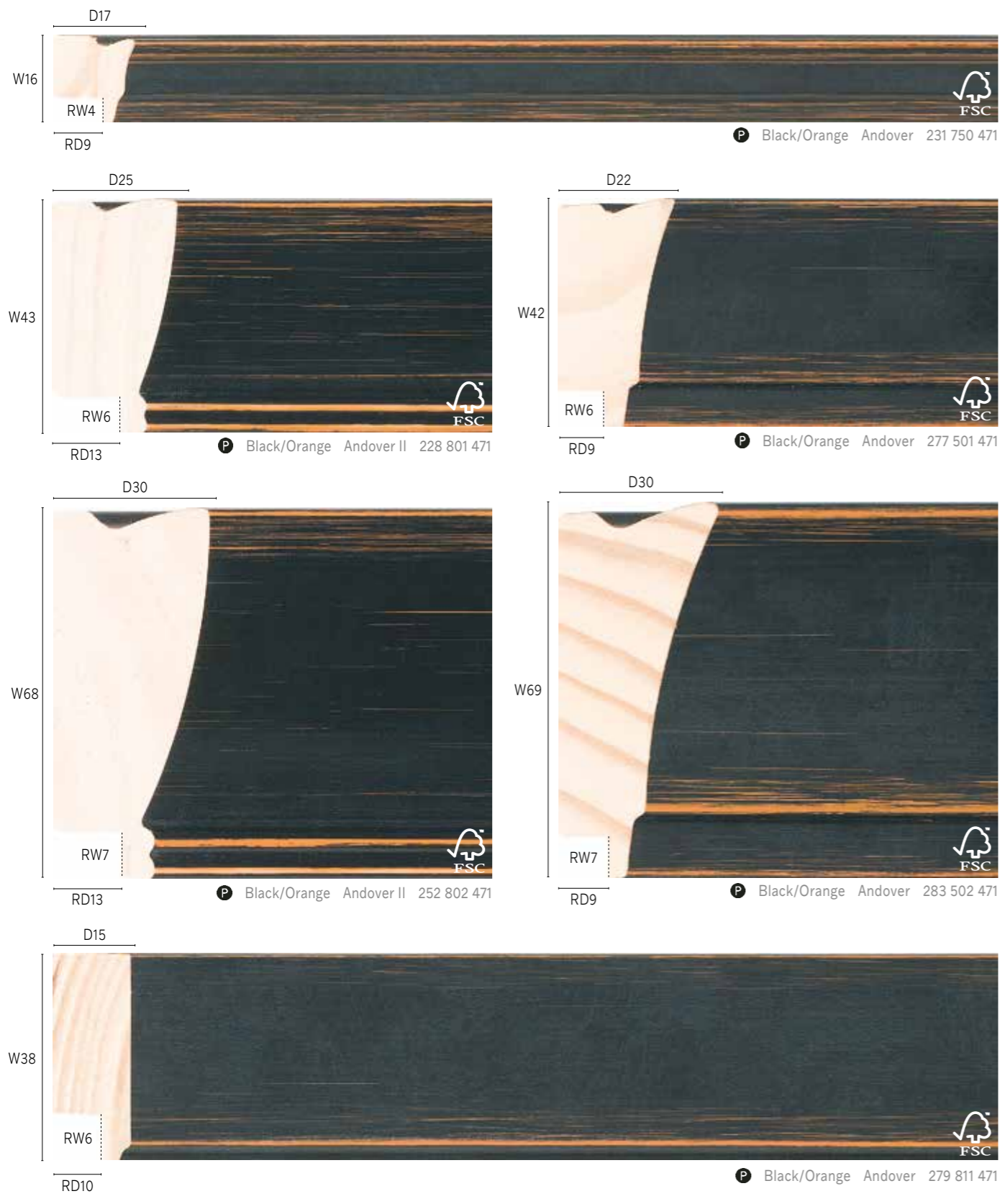

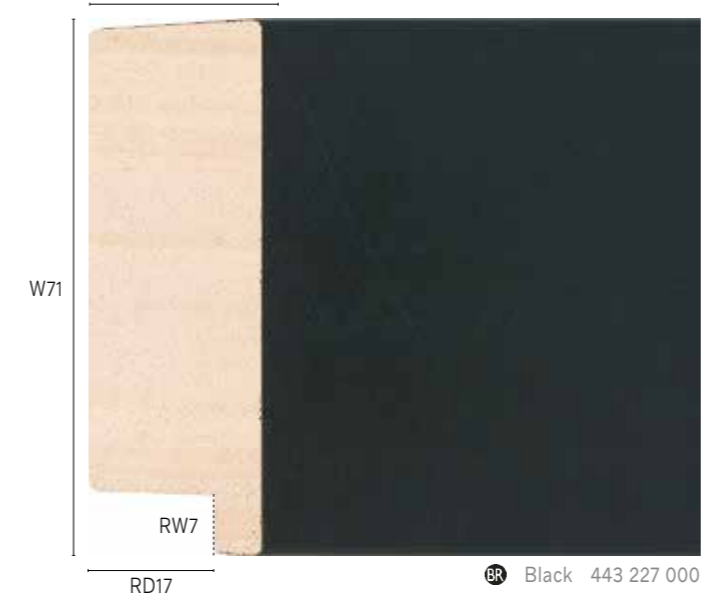
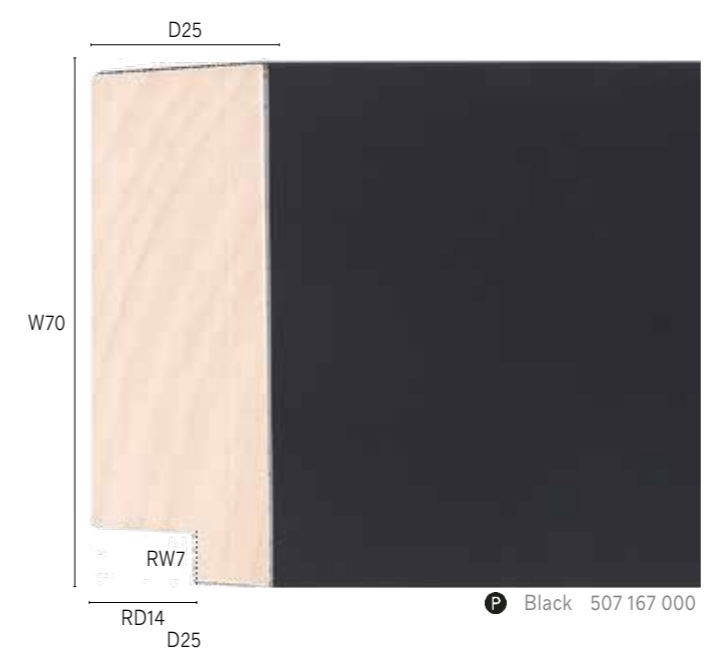
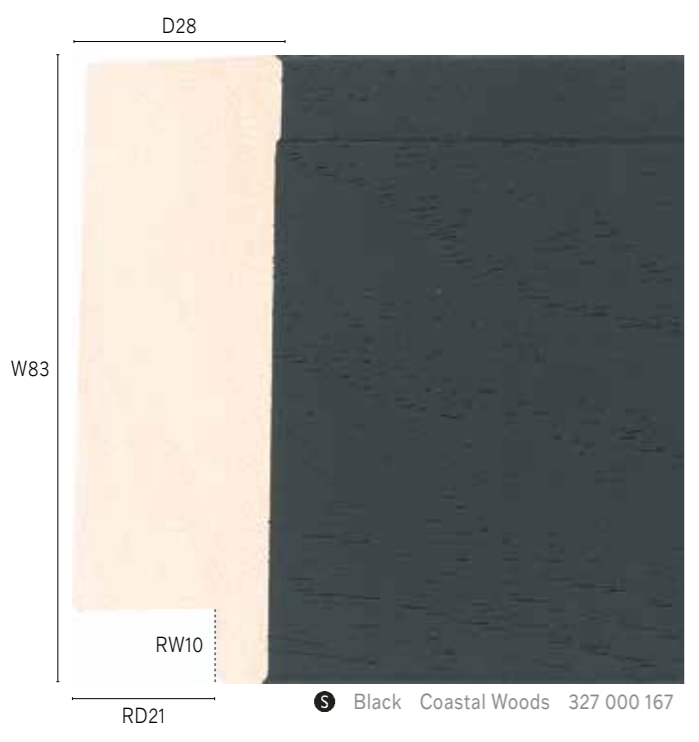
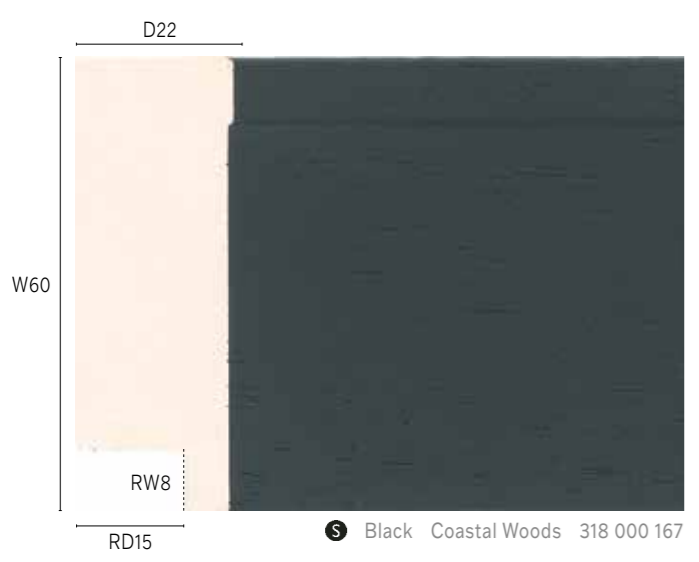
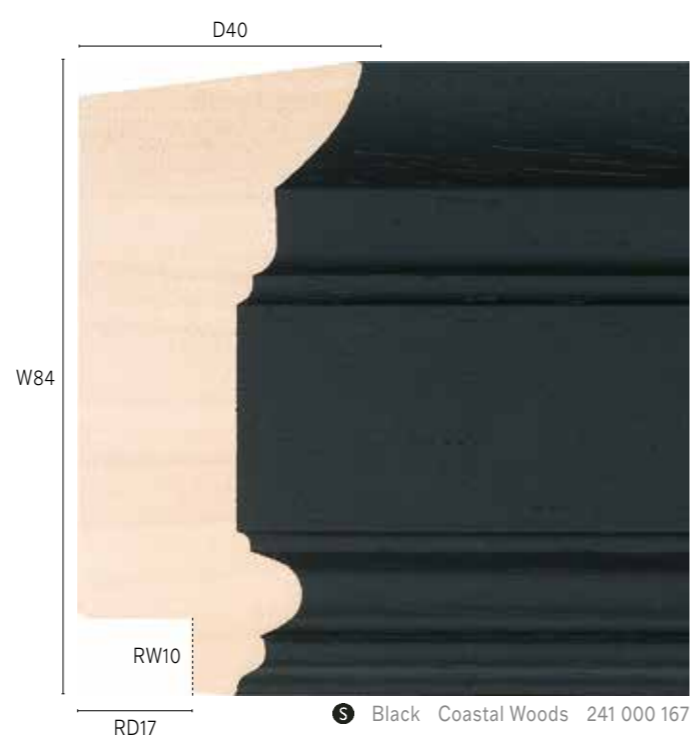
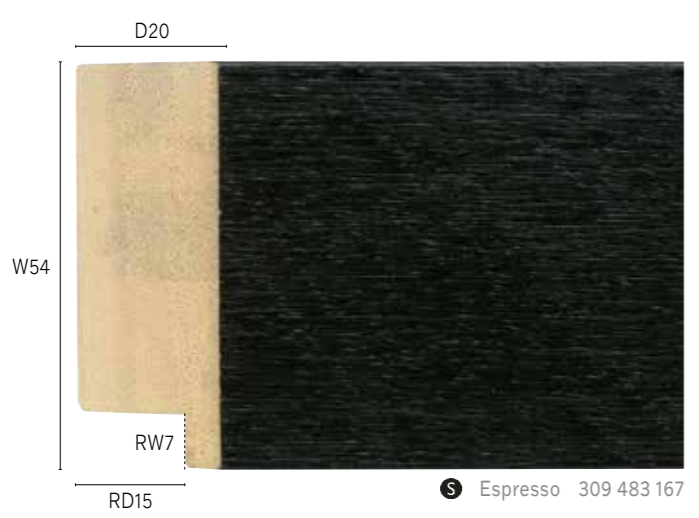

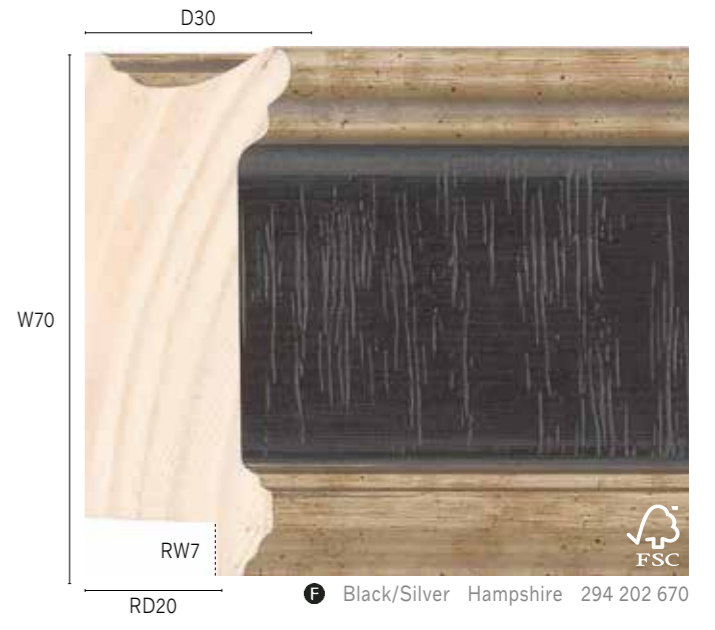
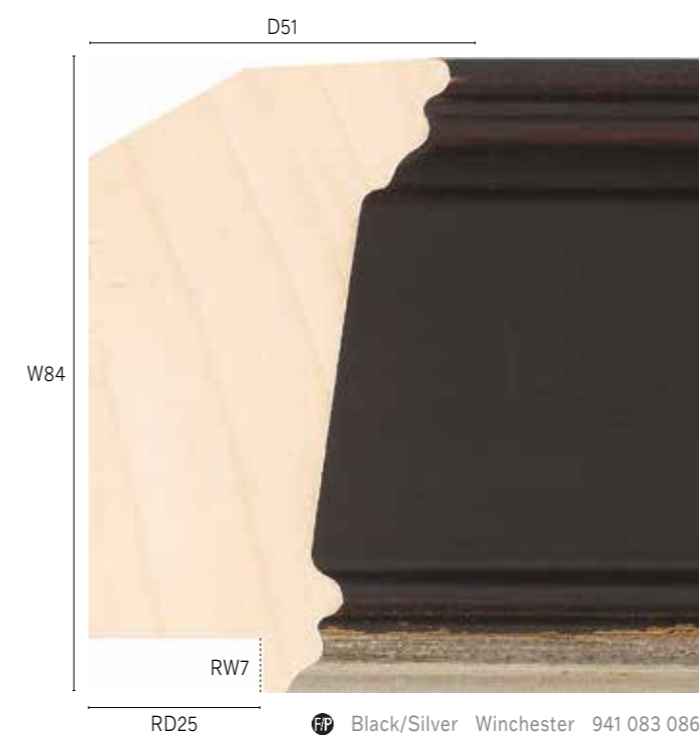
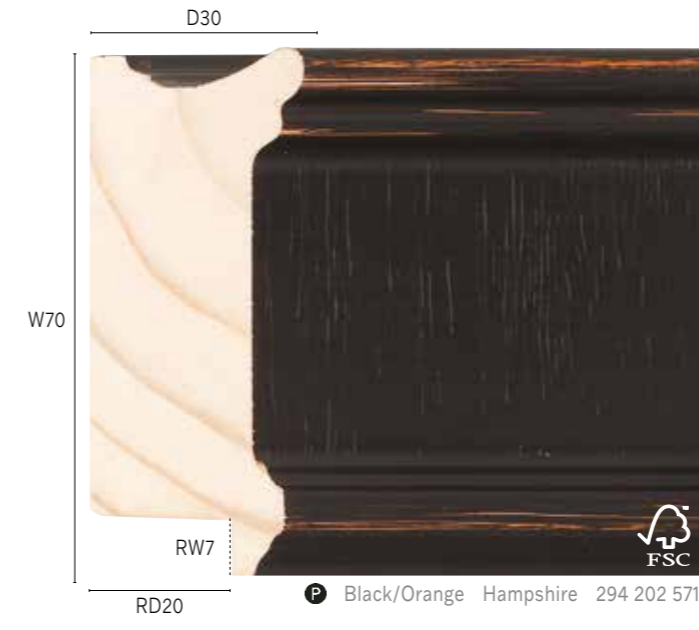

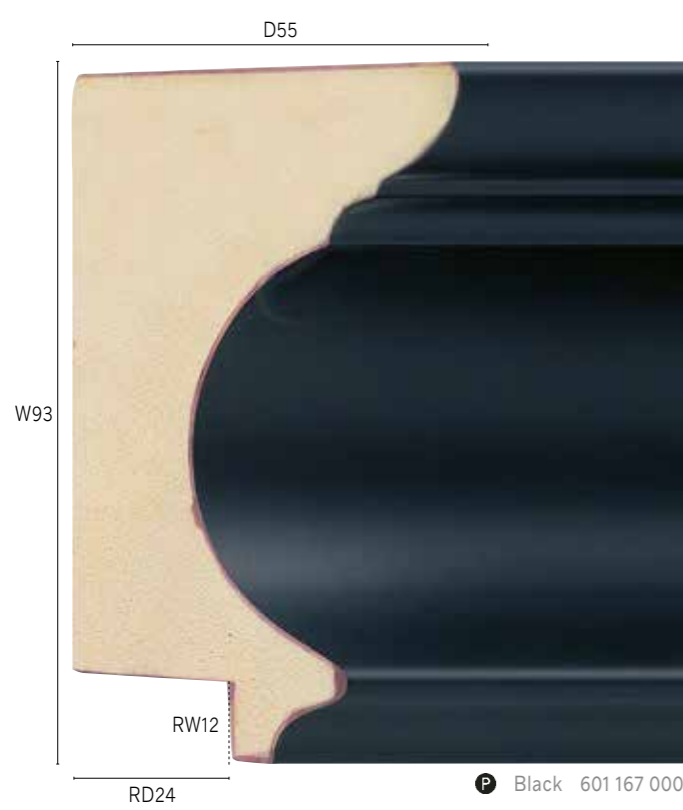

Black 601 167 000



Black Coastal Woods 226 000 167



Black 757 167 000



Black 706 249 000



Black 701 167 000



Black/Gold Verdi 911 186

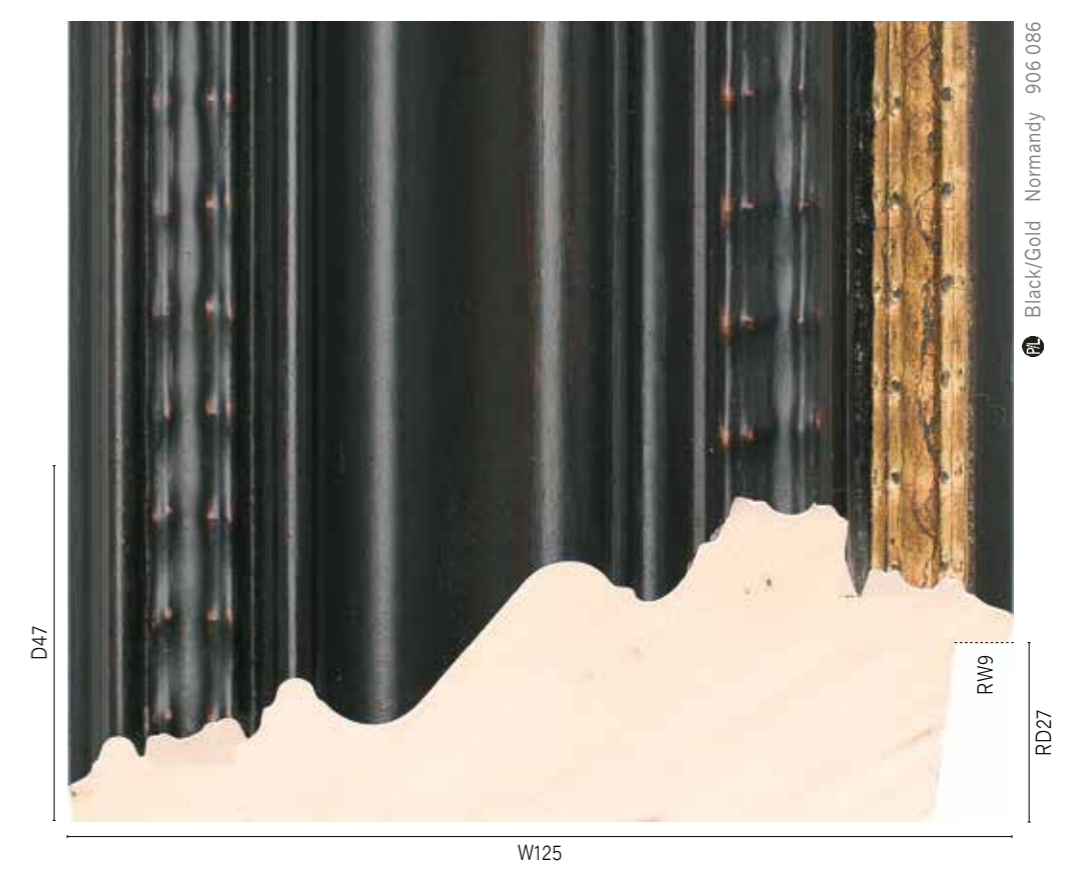
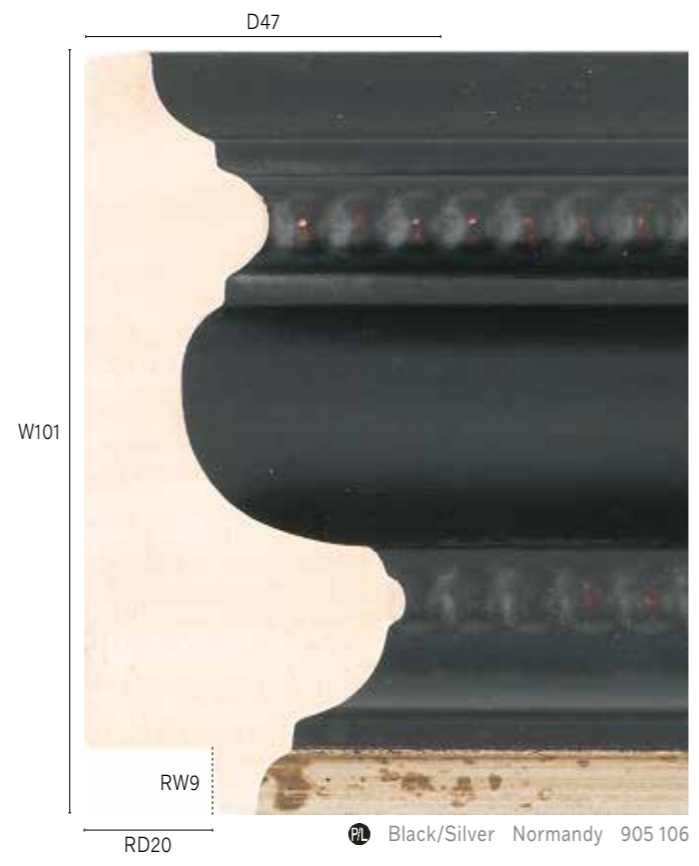
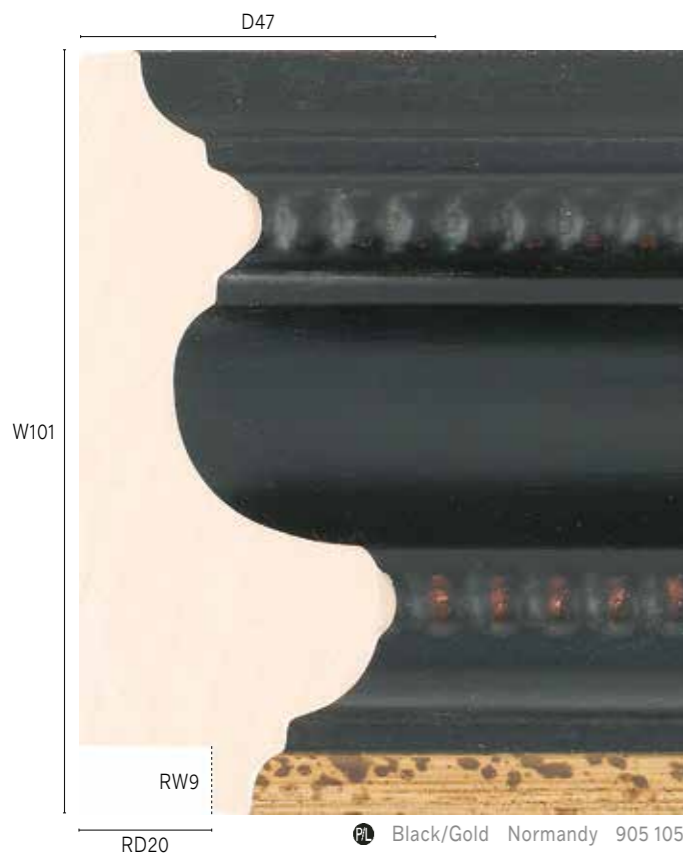
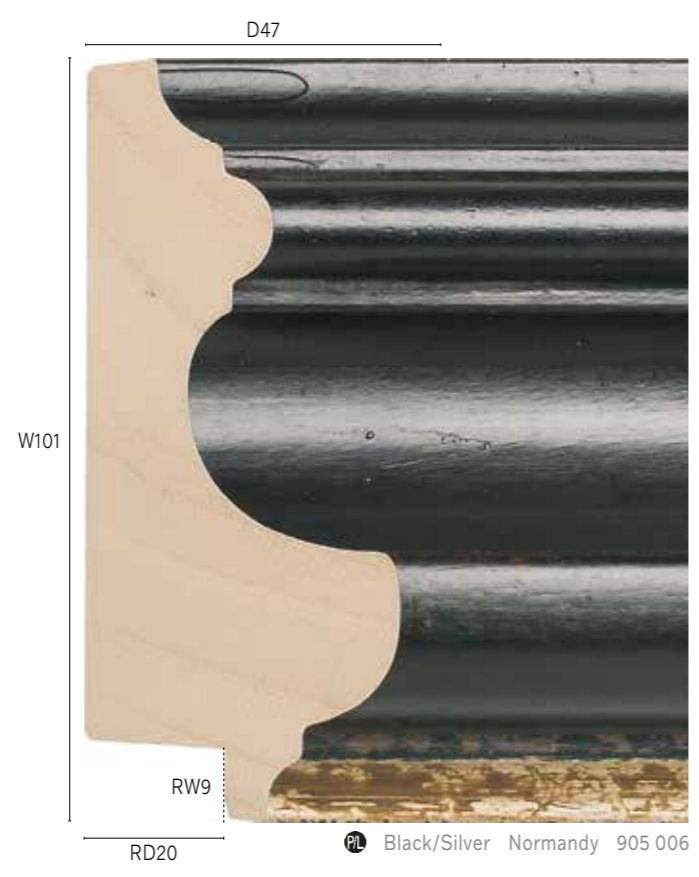

White

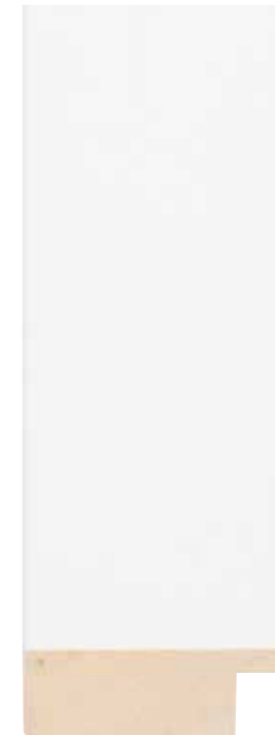

White

White mouldings are a popular choice for interior designers looking for a clean, crisp finish. Featuring a wide variety of profiles and finishes, including the Coastal Woods and Andover ranges.

Moulding used
412 127 000

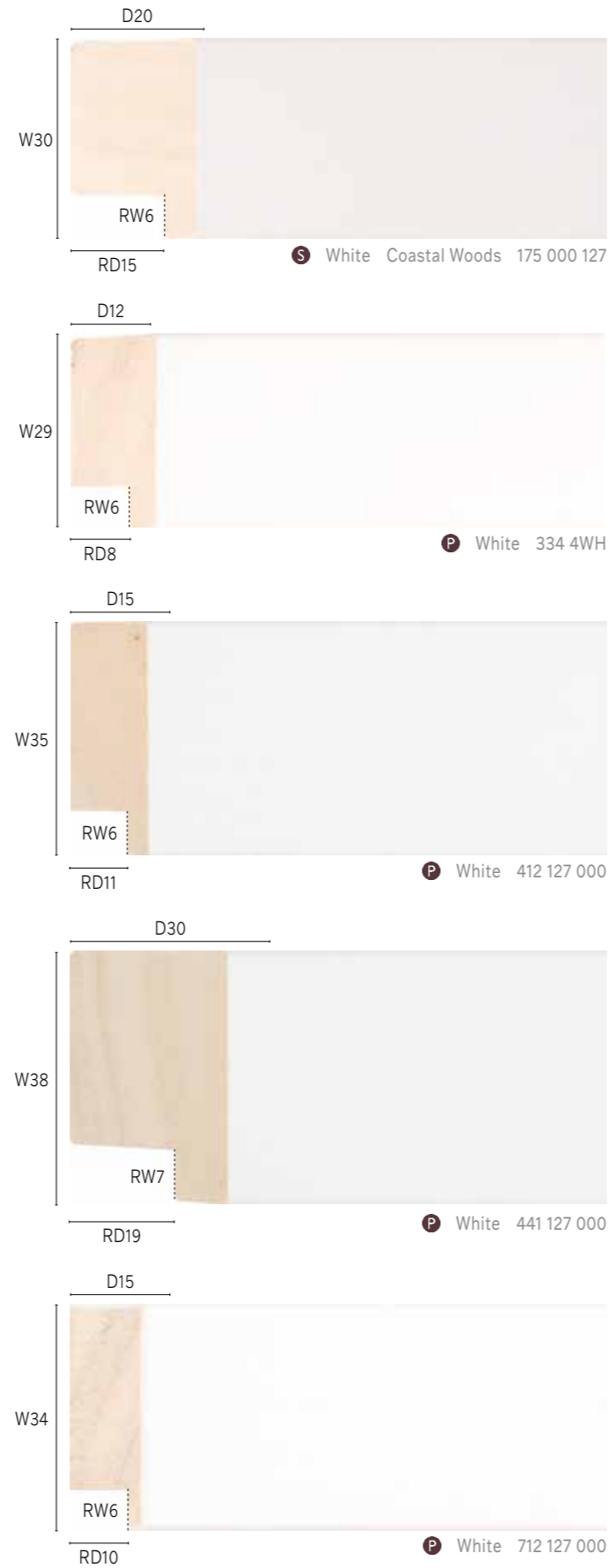

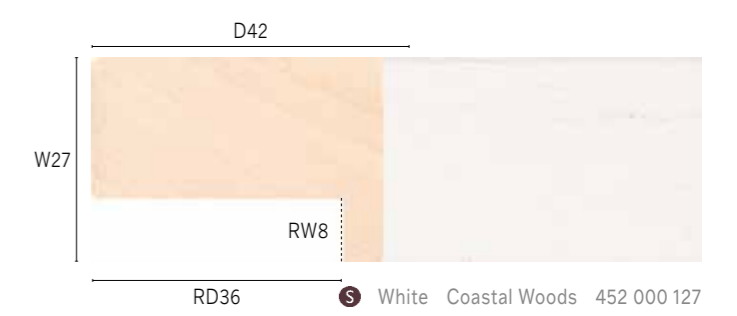
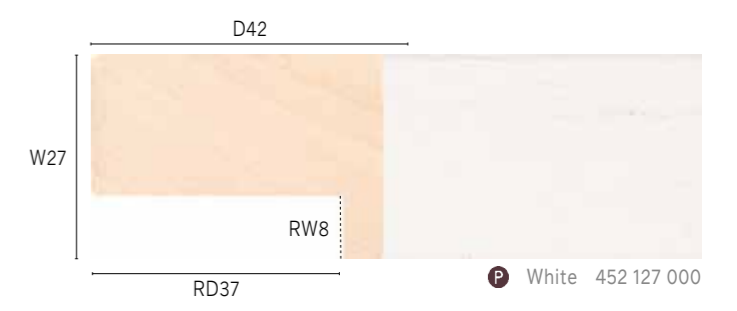
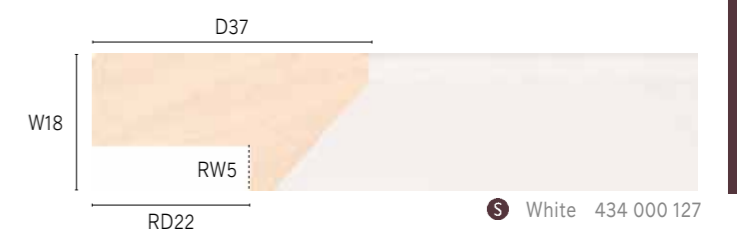
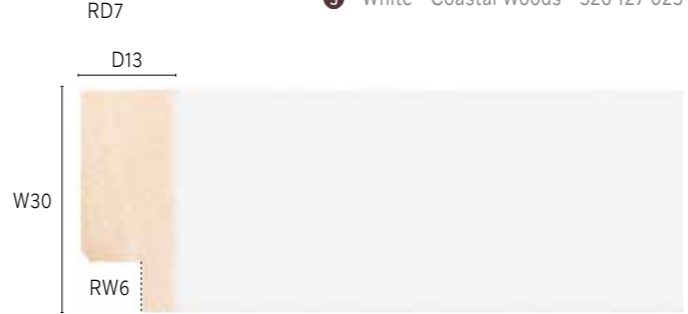
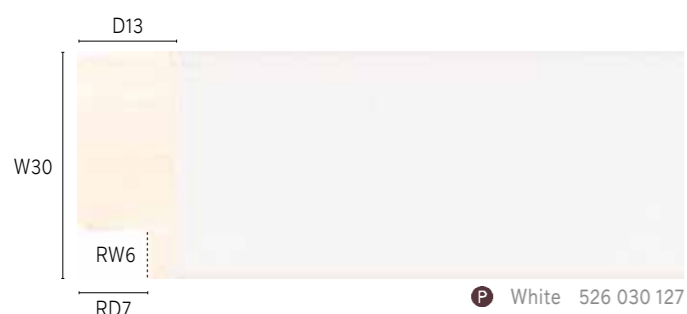
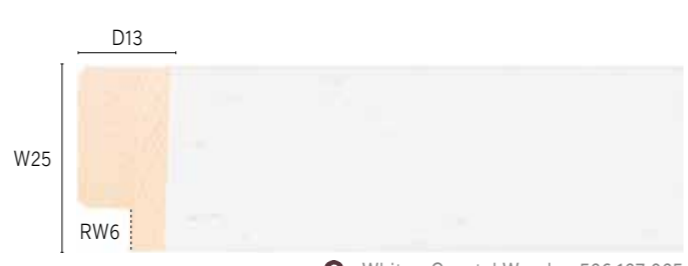
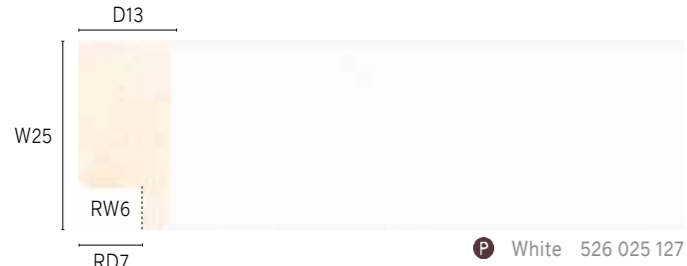
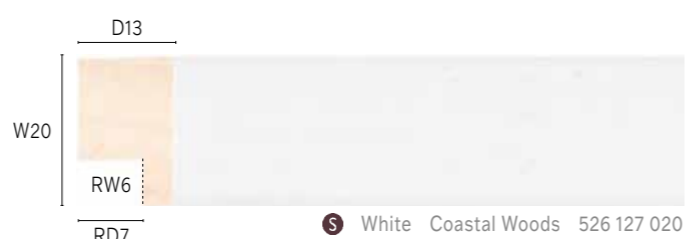
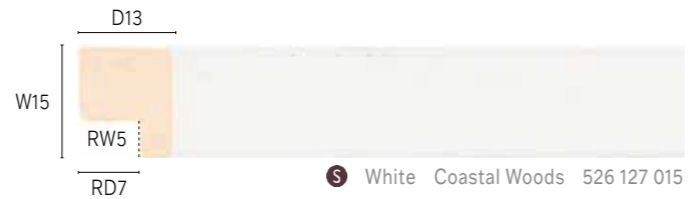
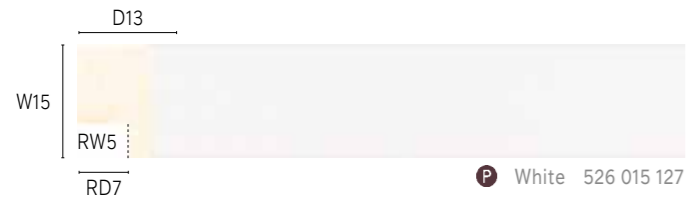

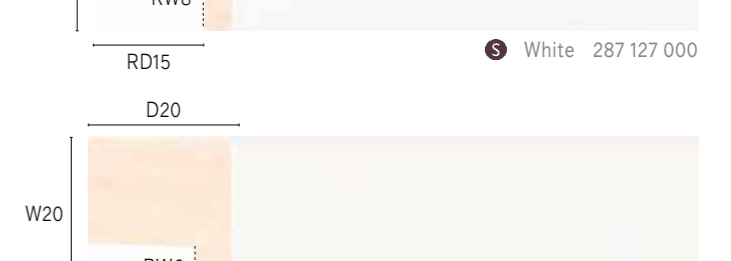
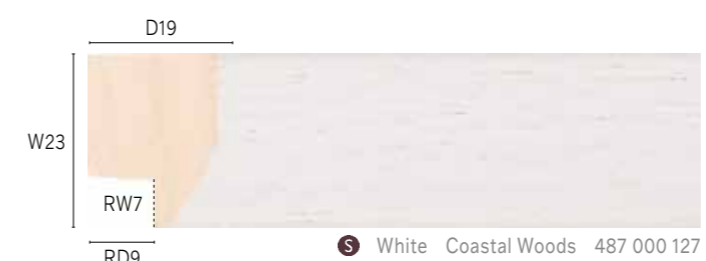
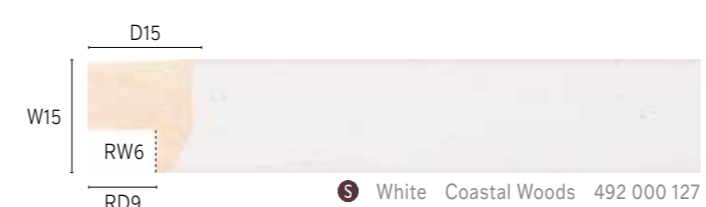
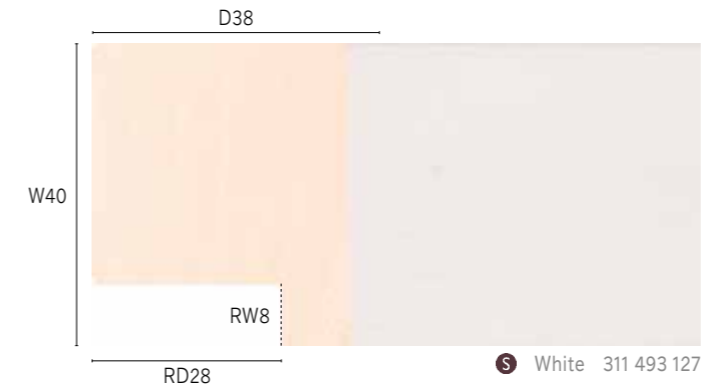
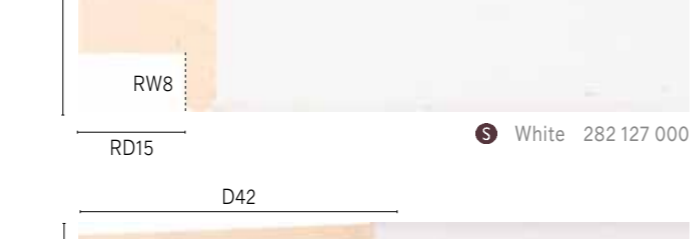
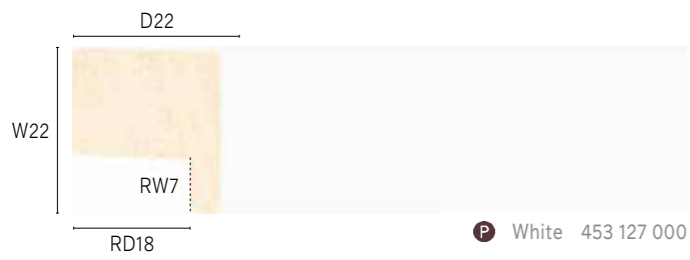
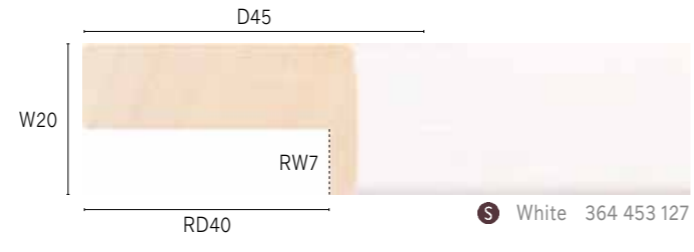

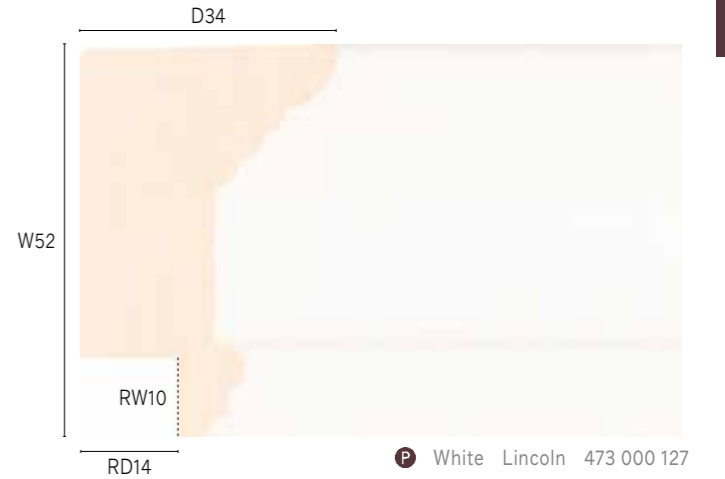
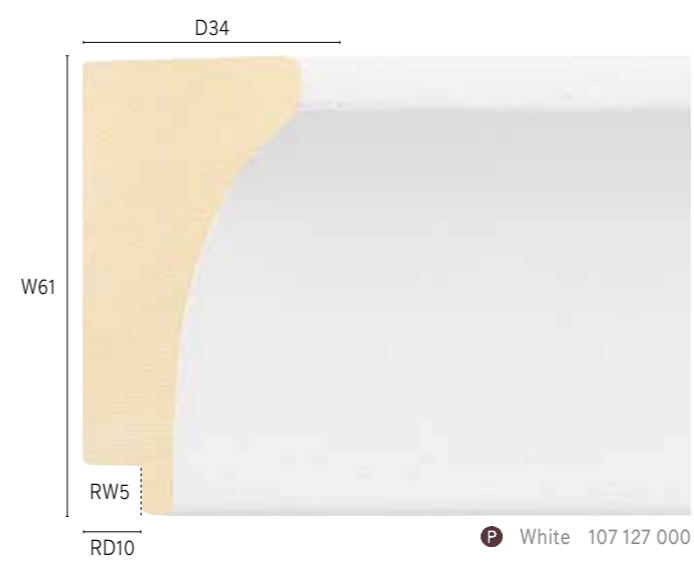
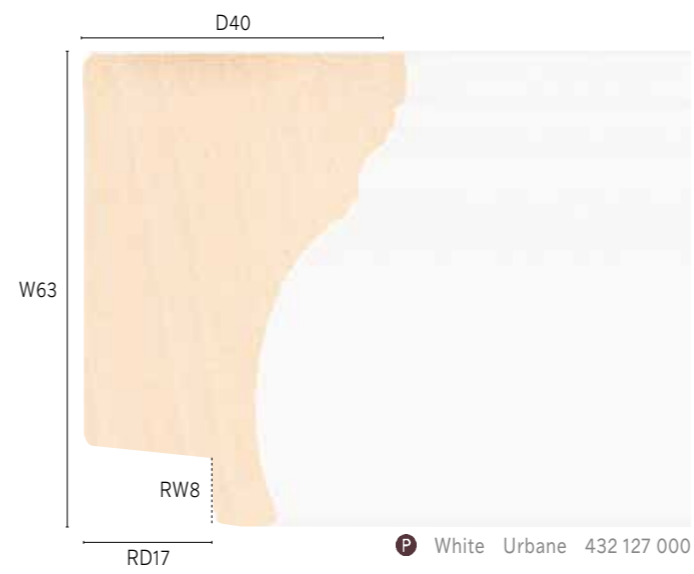
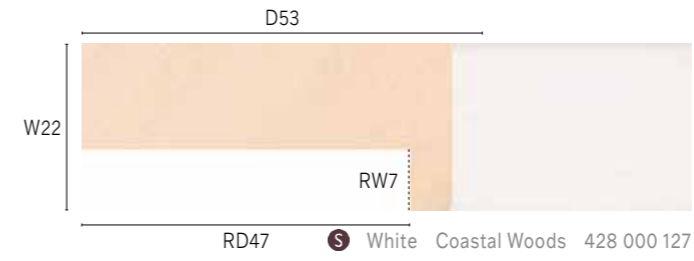
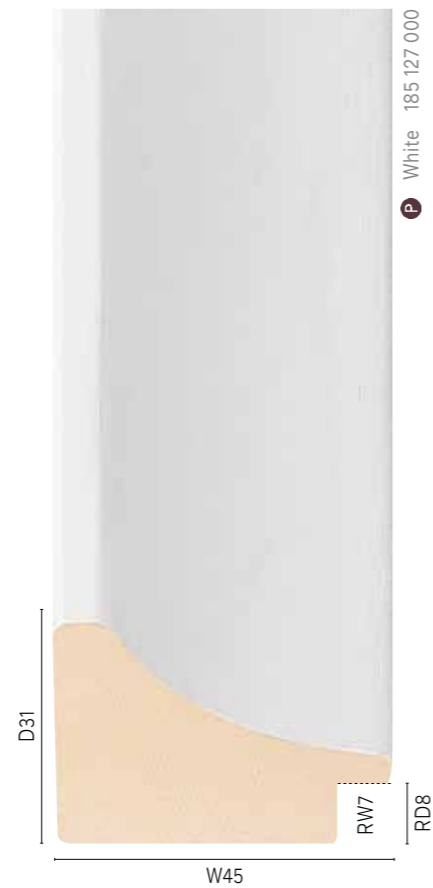
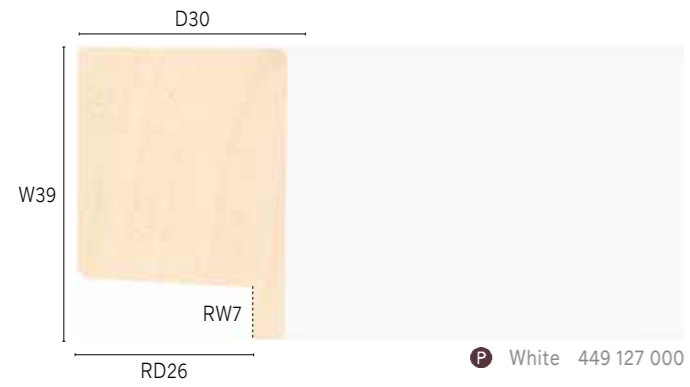

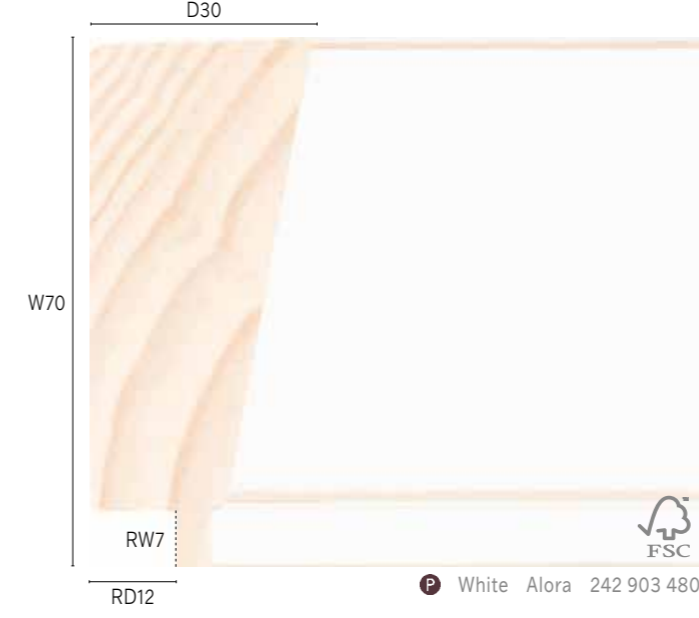
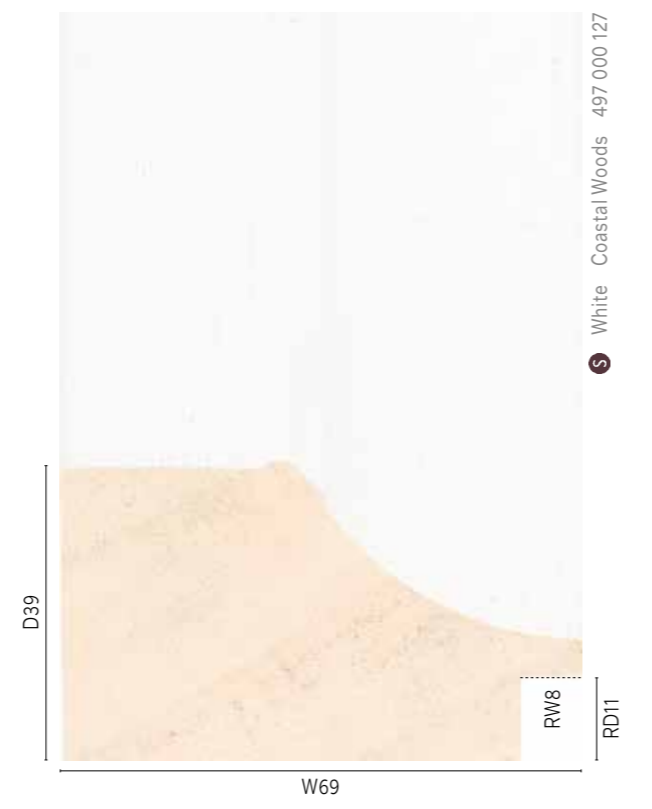
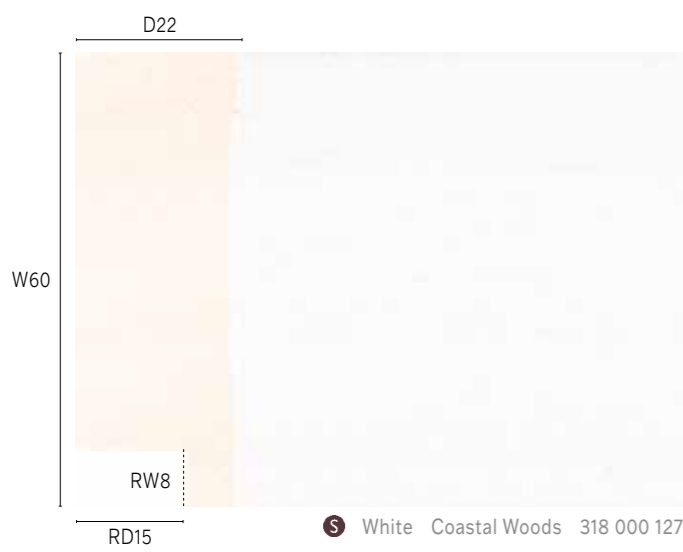
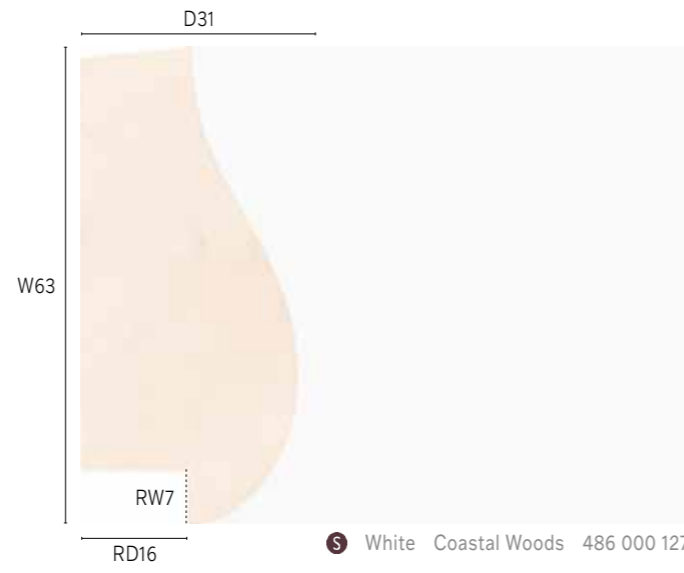
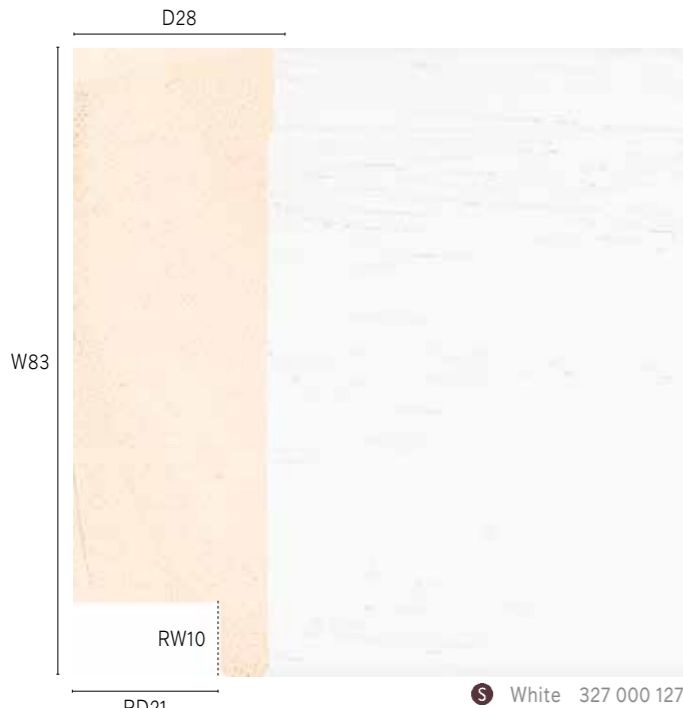

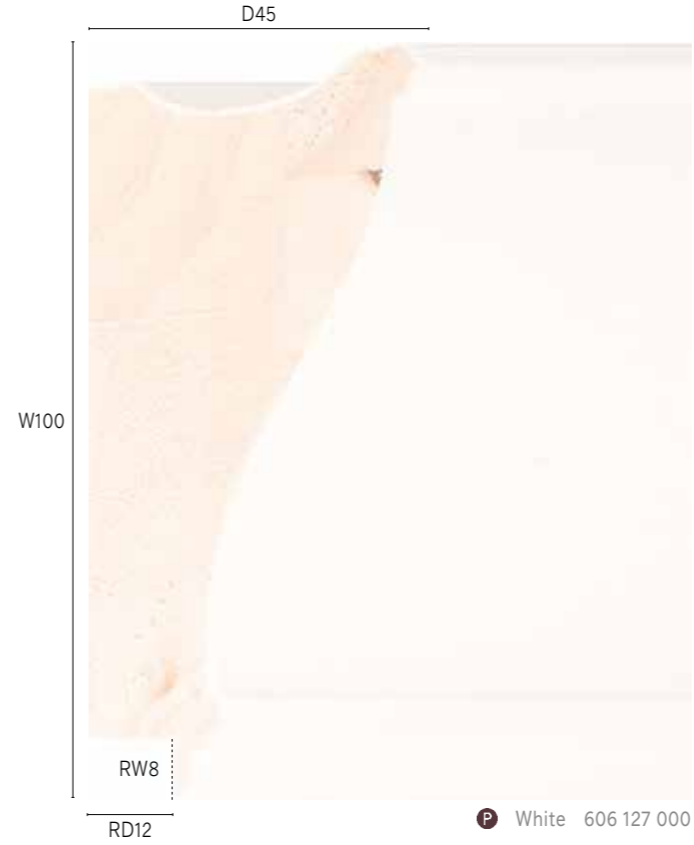
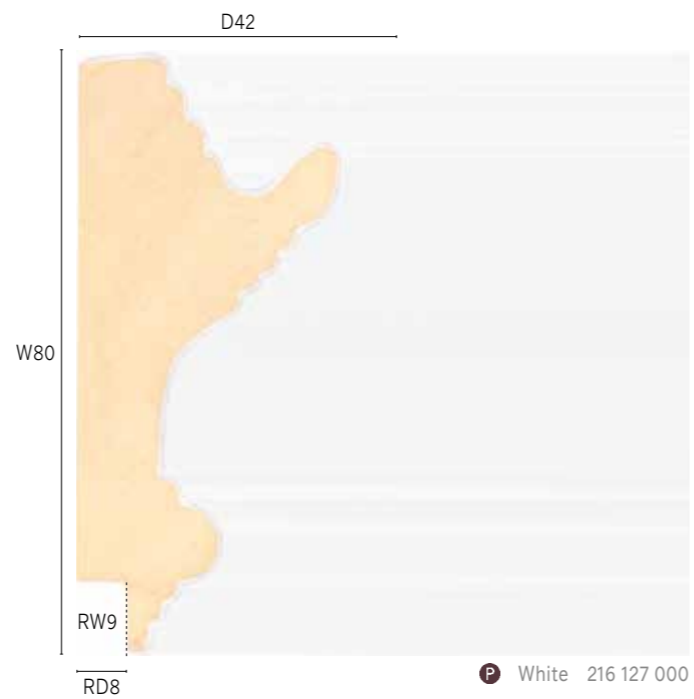
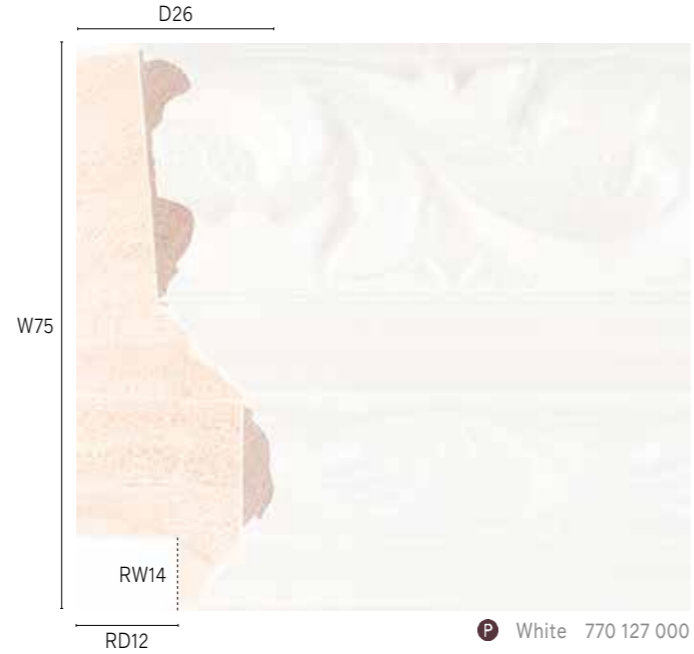



Colour



Colour

Covering something for all tastes, we offer a variety of coloured profiles. From the washed effect of the Simplicity range to the modern effect of the Barranda collection, there is sure to be something to suit any framing project.



Moulding used

217 170 549

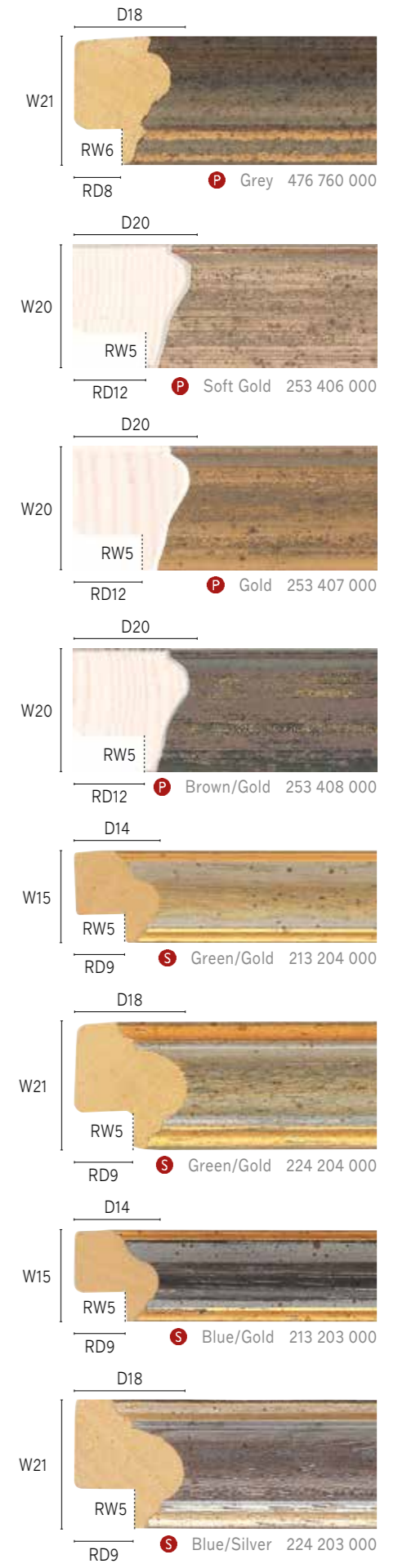

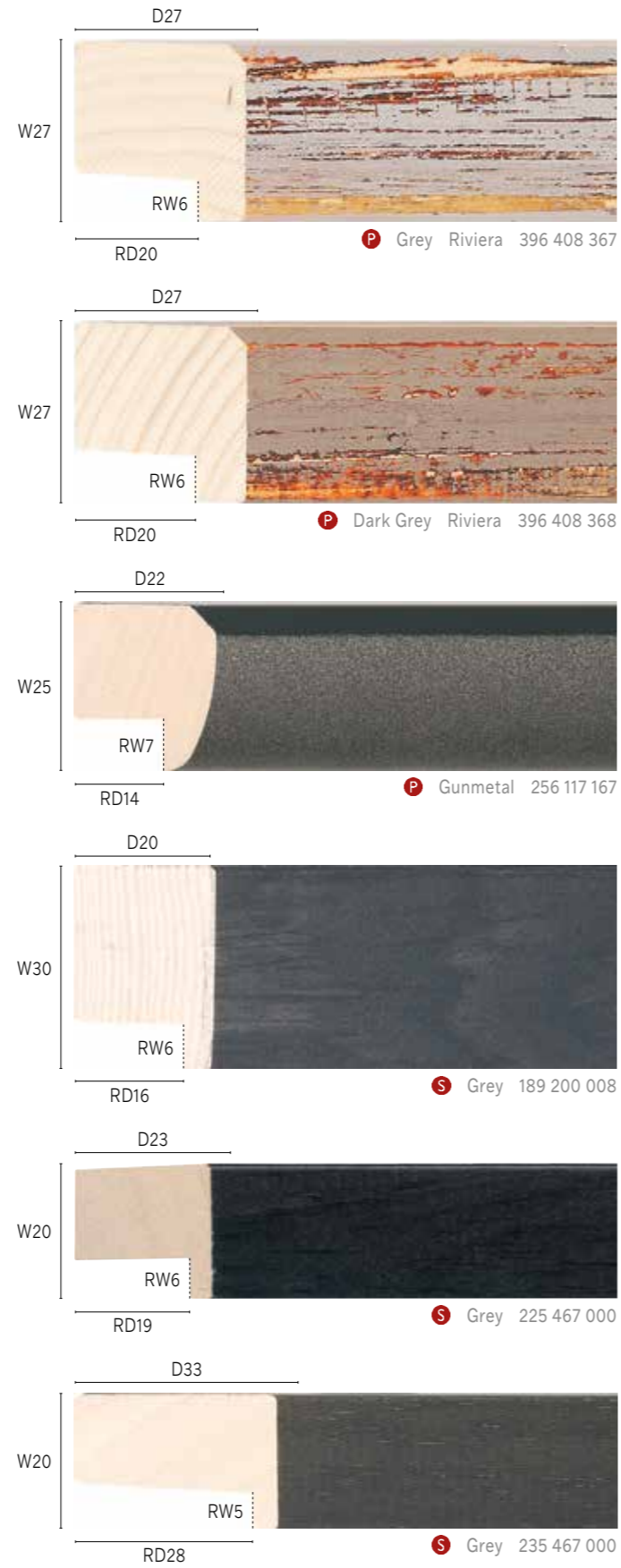
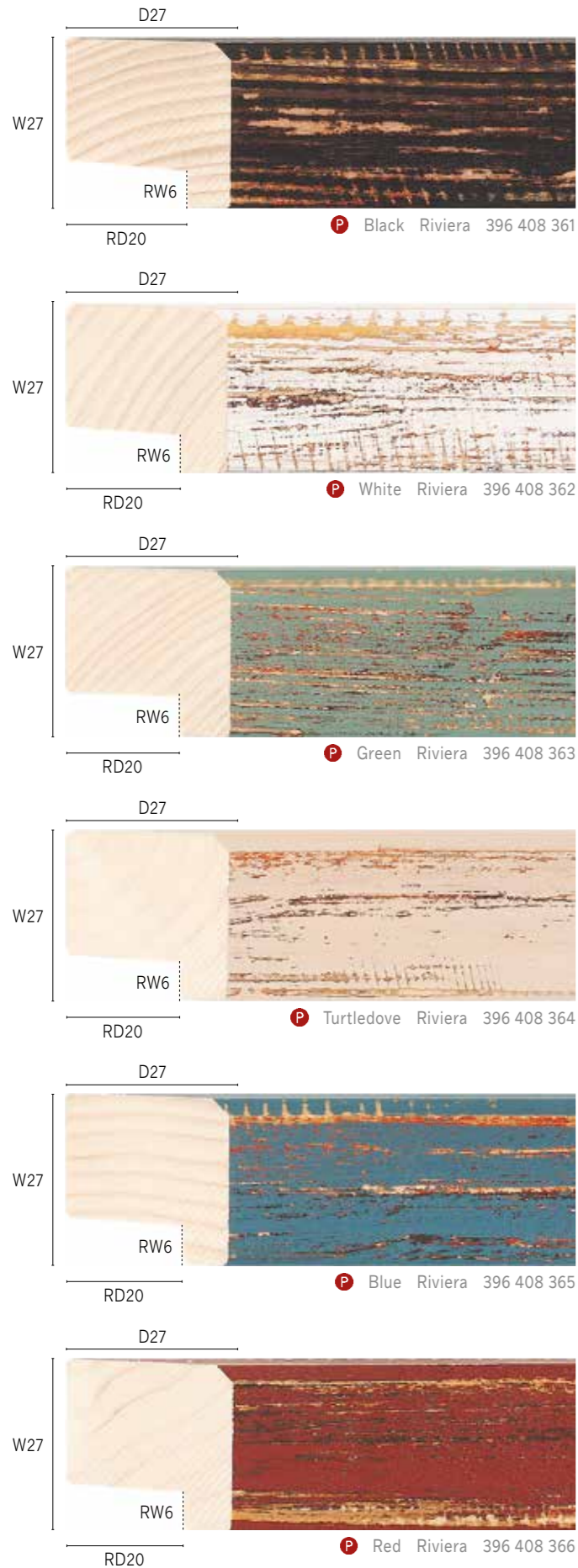

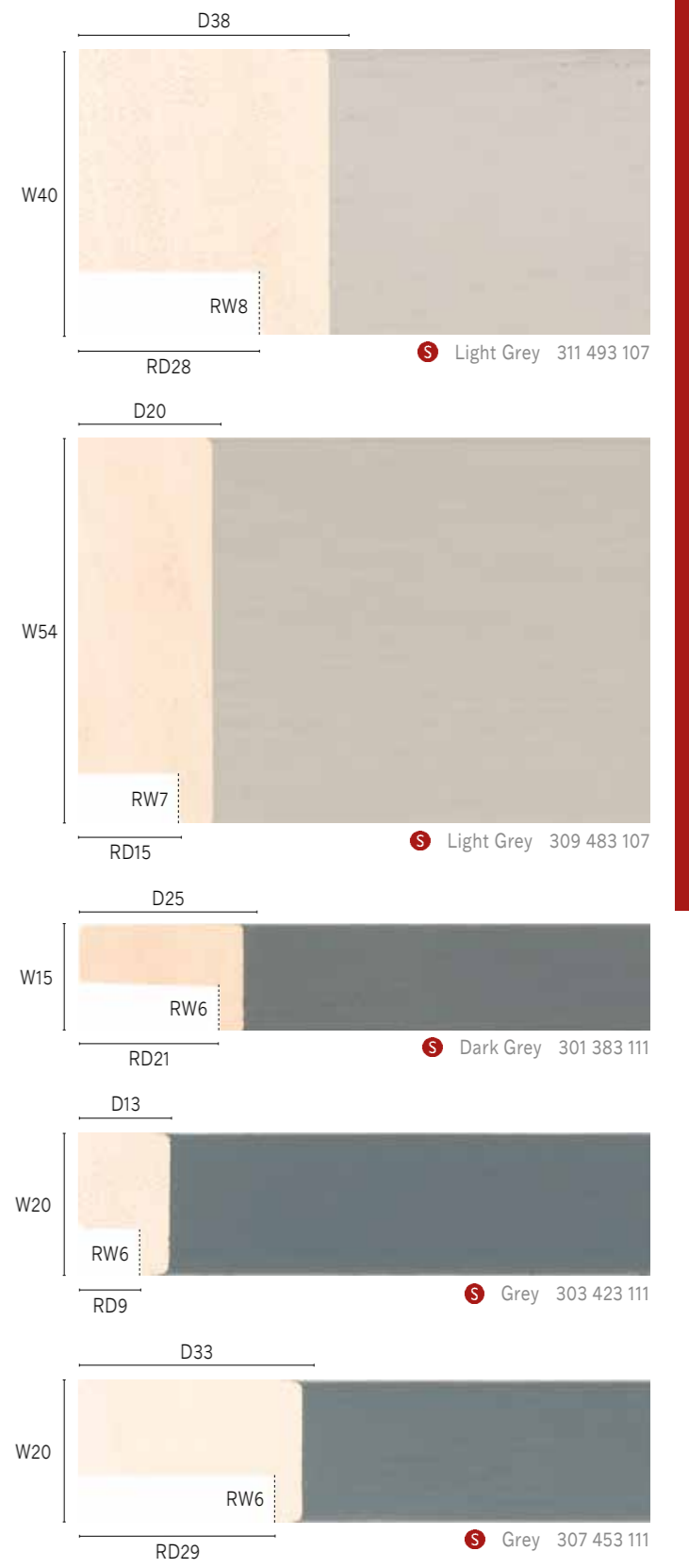
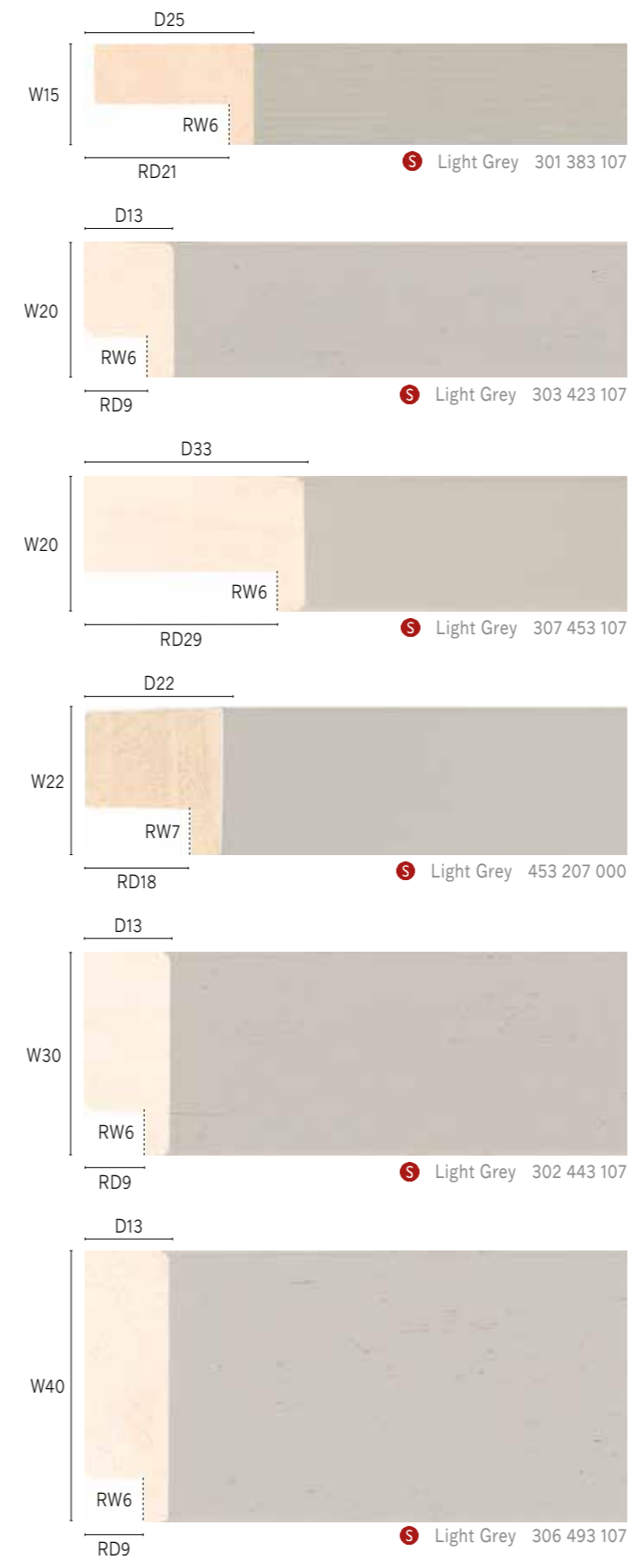
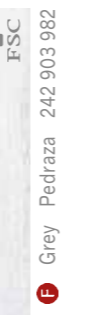
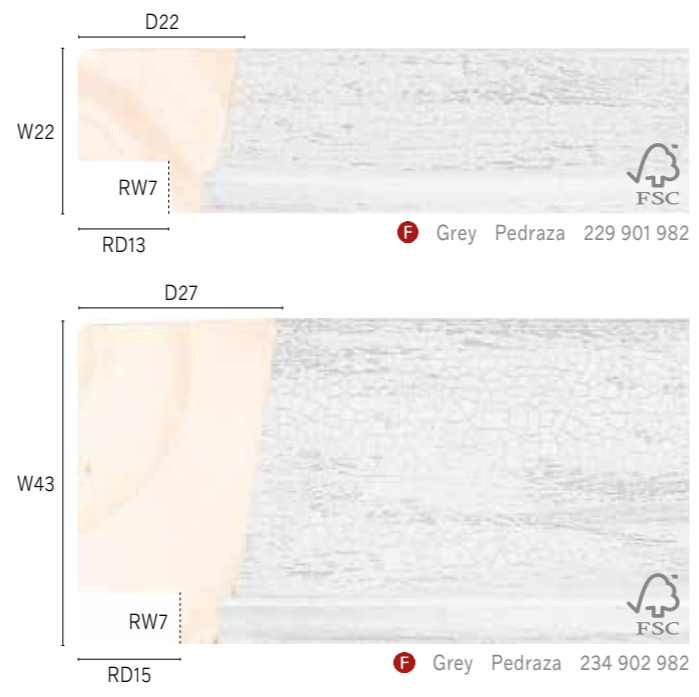
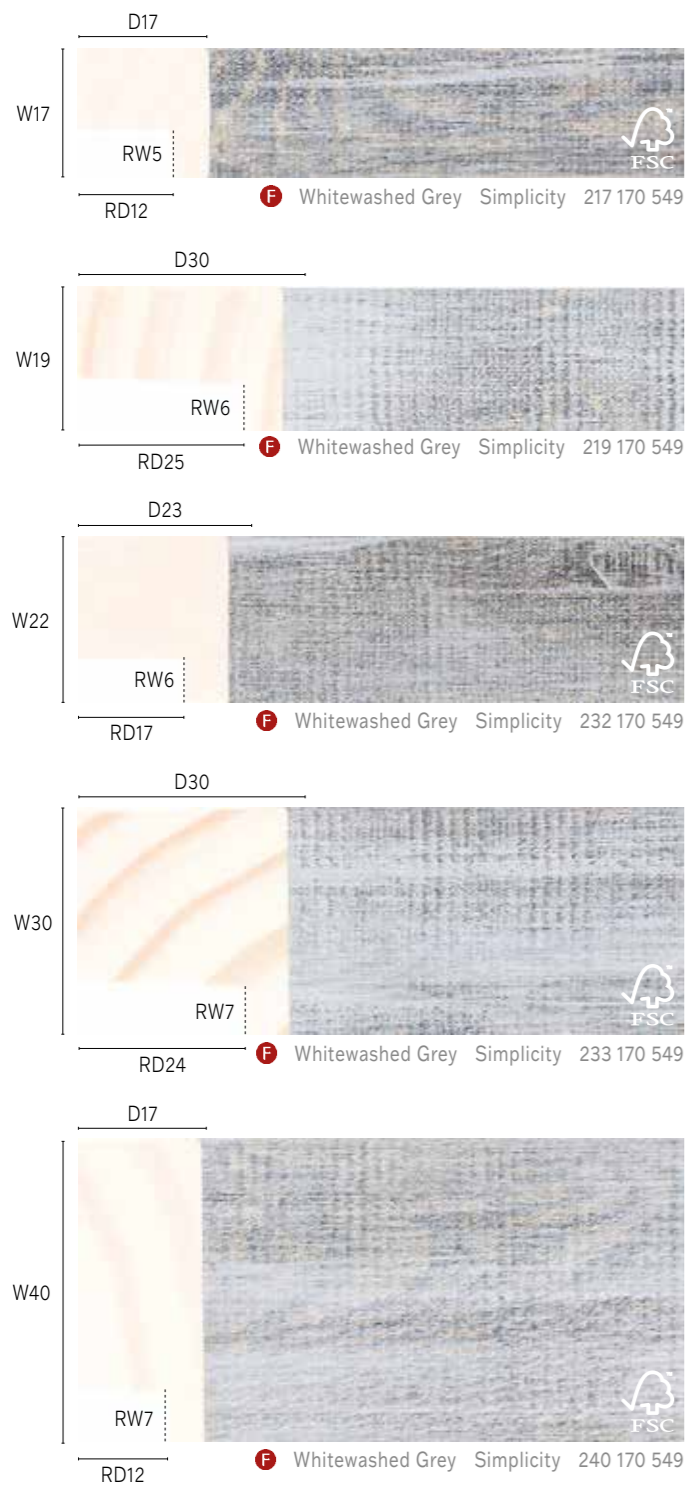

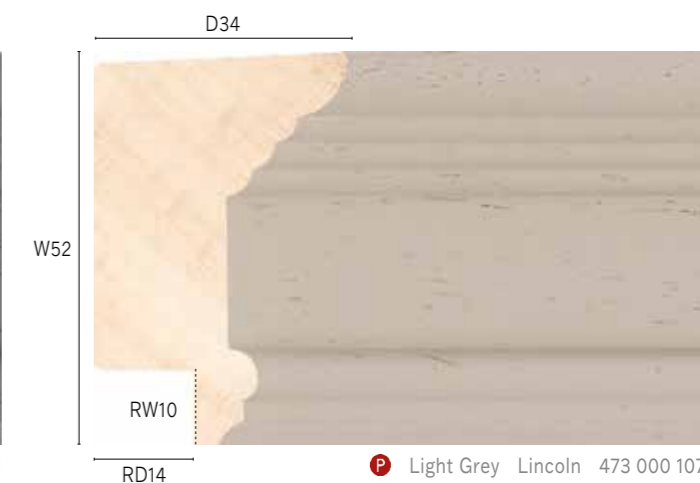
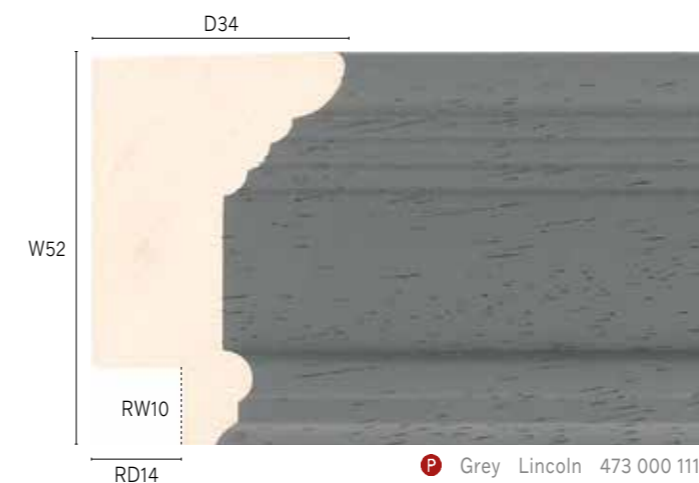
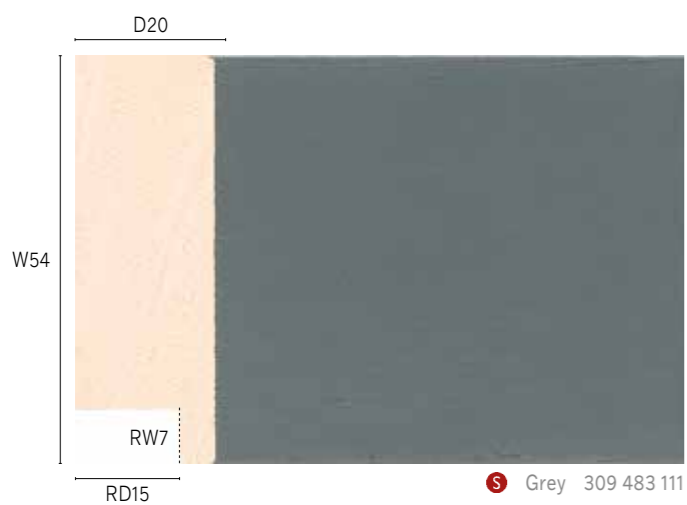
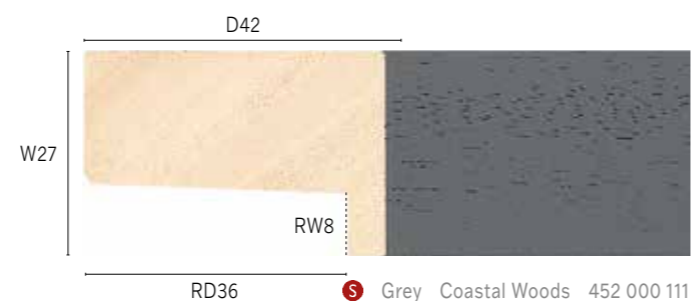
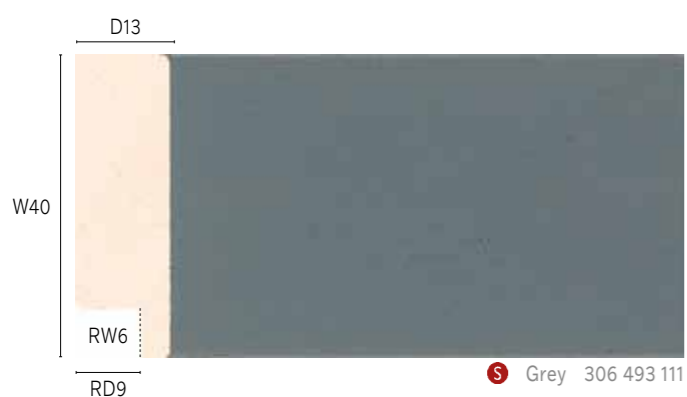

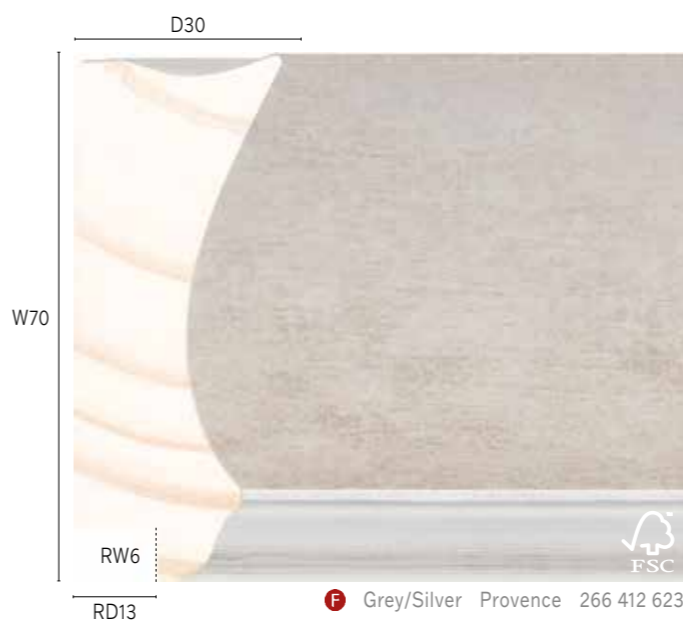

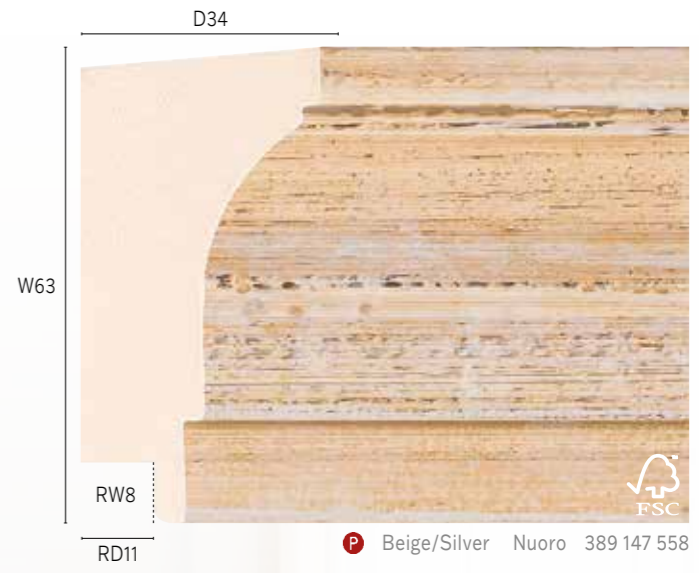



Black/Cream/Gold Chambery 908 045

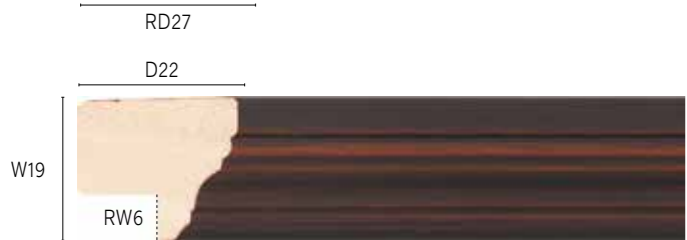

Burgundy Urbane 455 436 000

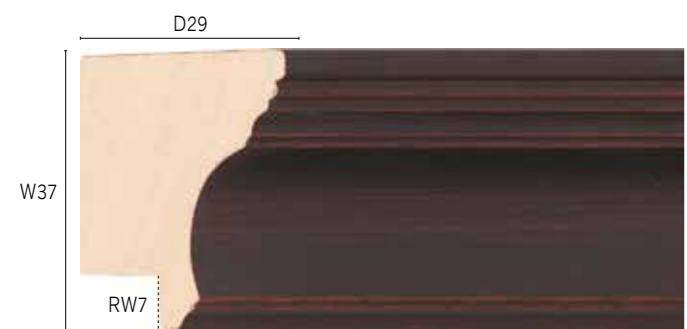

Burgundy Urbane 450 436 000

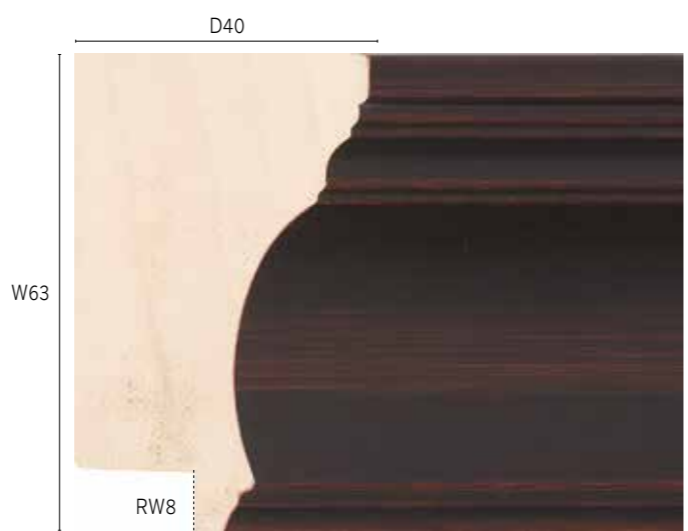

Burgundy Urbane 432 436 000



Rust TouchStone Art 991 100 247



Light Grey TouchStone Art 991 079 242



Light Grey TouchStone Art 991 100 242



Light Grey TouchStone Art 991 137 242

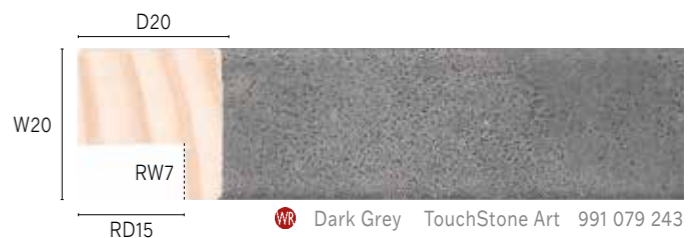

Dark Grey TouchStone Art 991 079 243



Dark Grey TouchStone Art 991 083 243



Dark Grey TouchStone Art 991 100 243

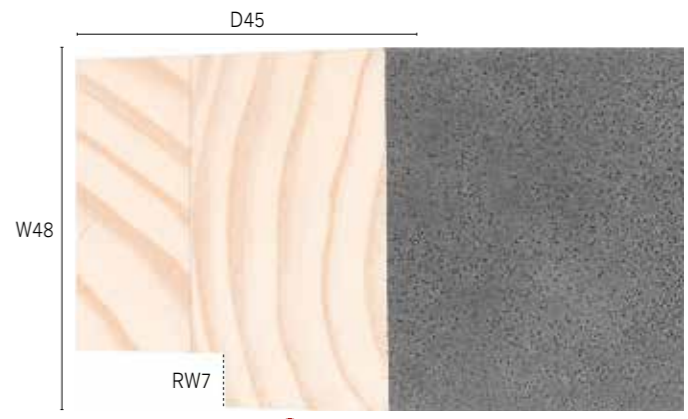

Dark Grey TouchStone Art 991 137 243



Coloured Lacquer

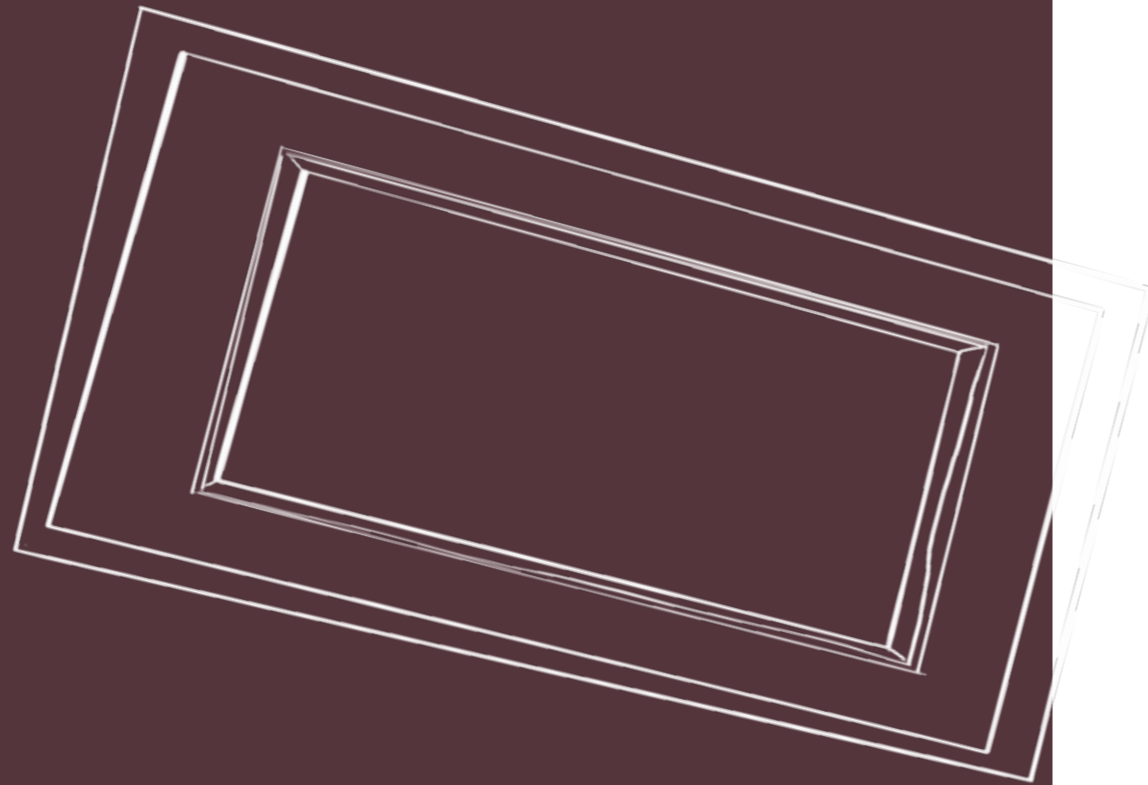

Moulding used
KL8 690 02



Coloured Lacquer



With styles to suit every project, from small cushioned profiles to a large range of decorative, lavish Baroque, our coloured lacquers are versatile and immaculately finished. The range also includes two float profiles in black and white.

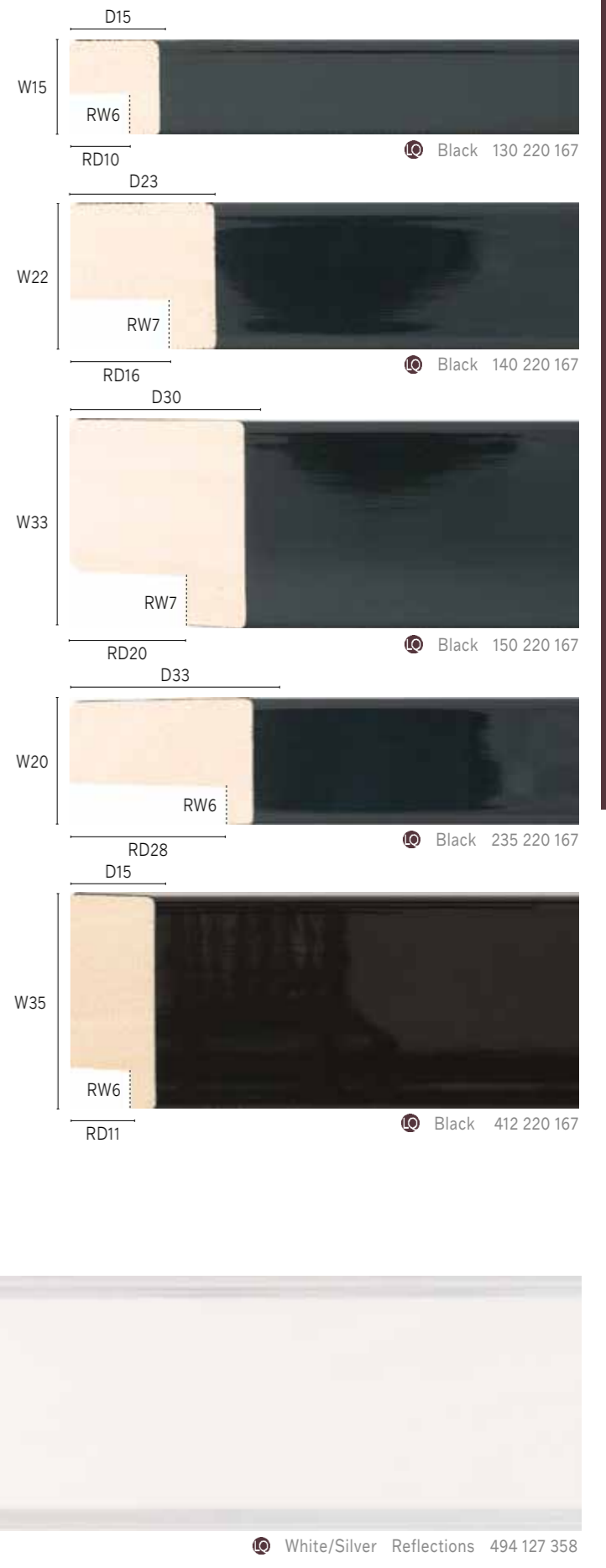
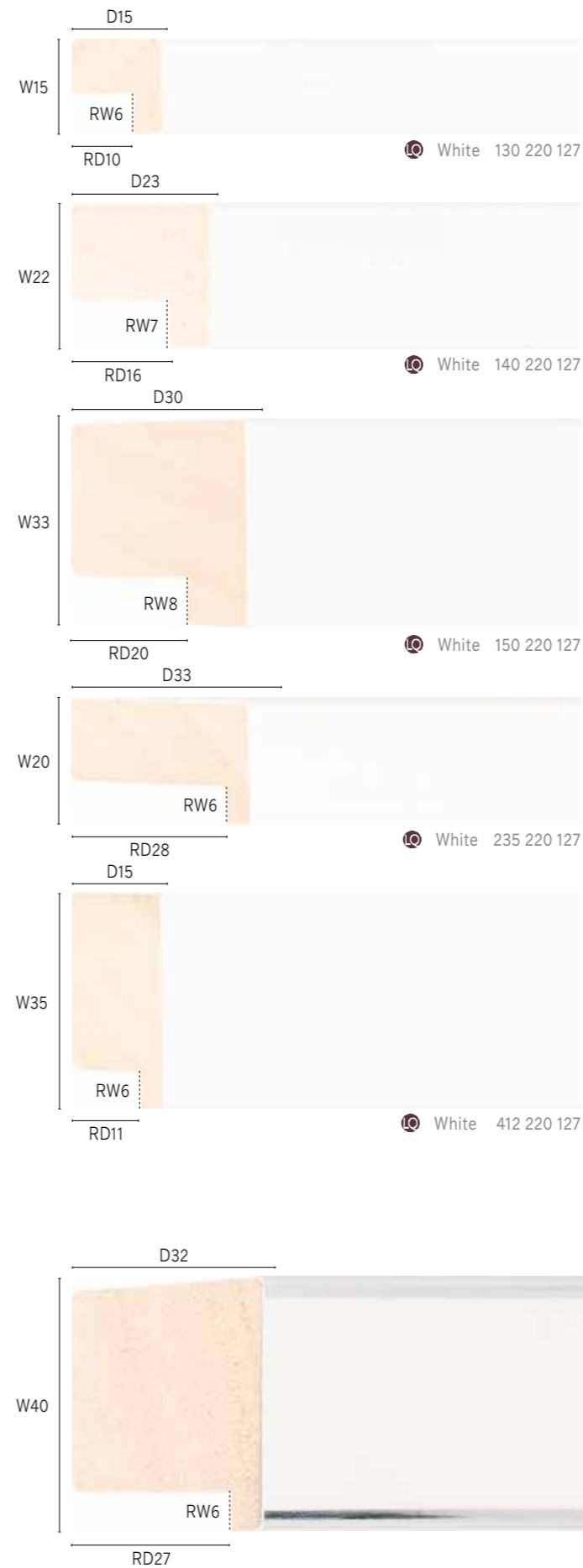

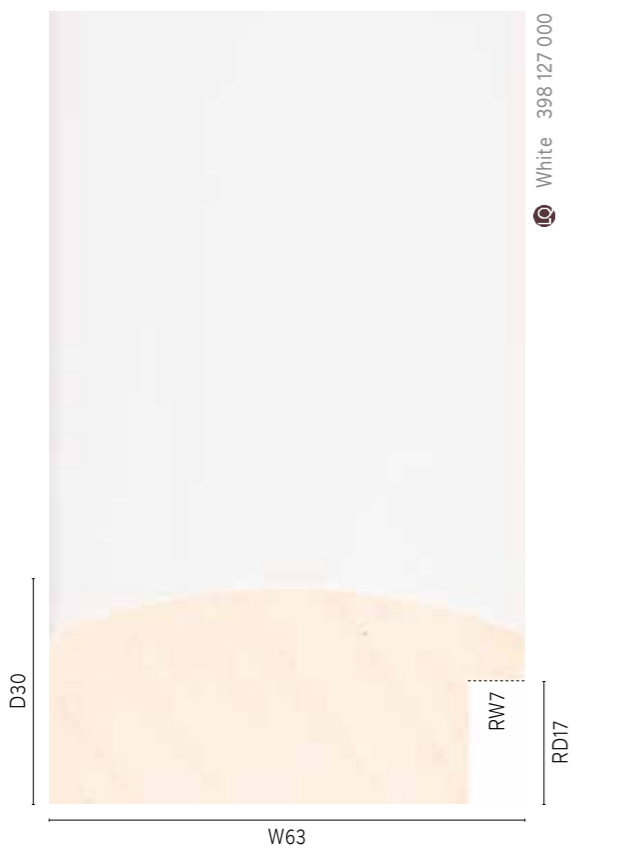
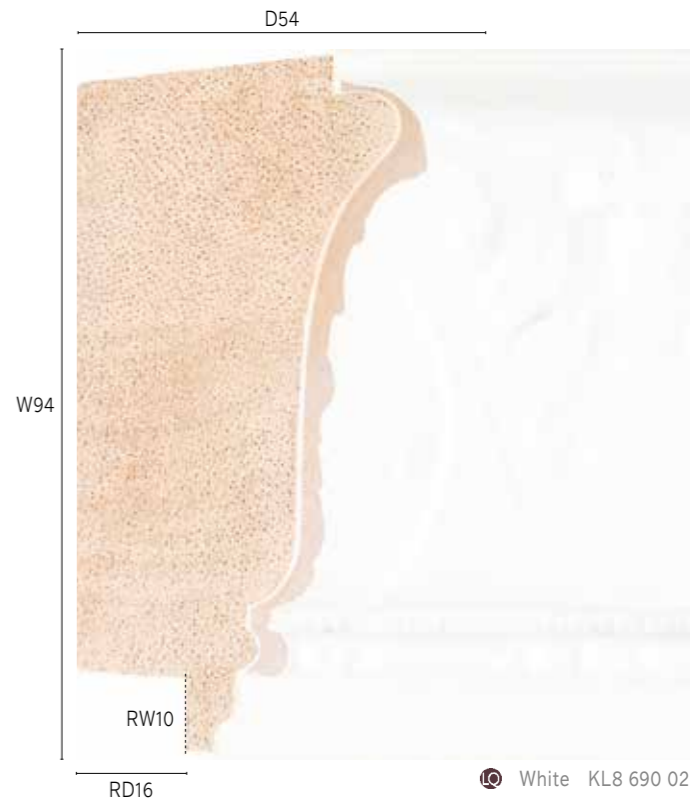
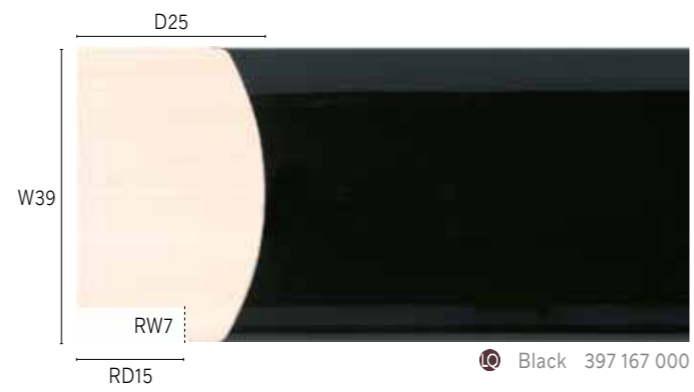
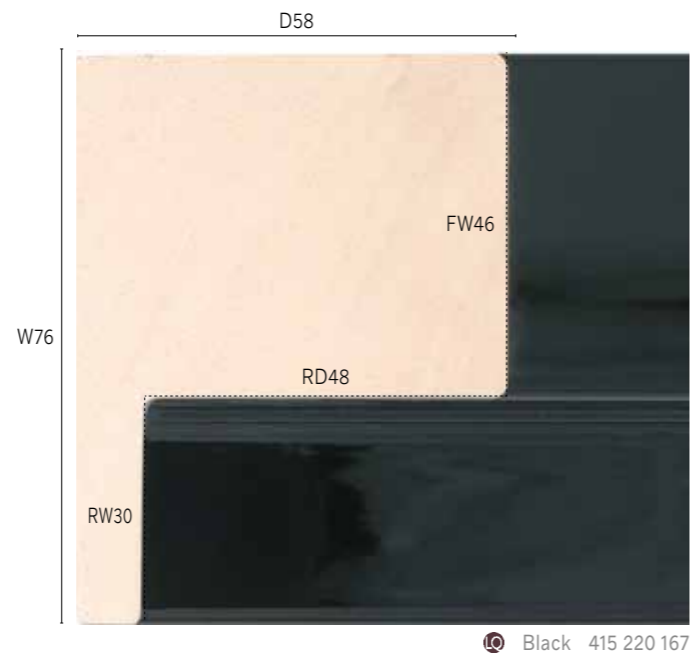
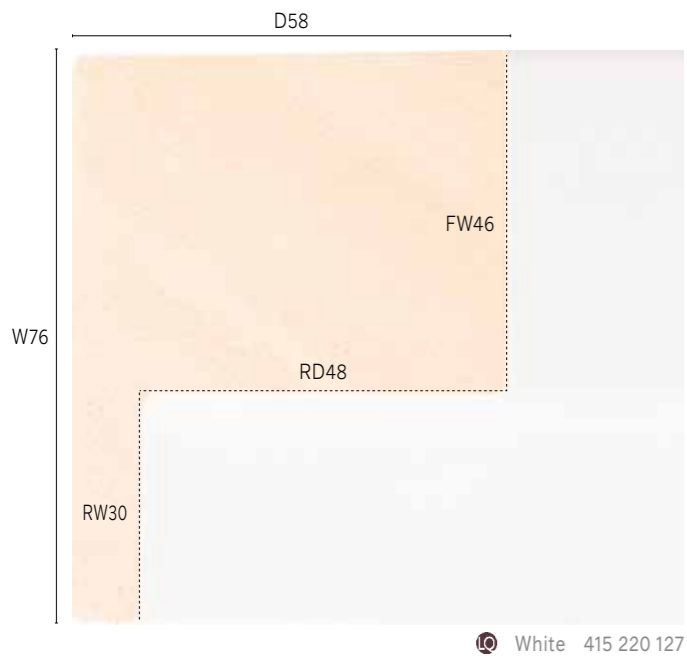

Plain and Decorative Wood

Plain and Decorative Wood

With a trend for warmer, darker and moodier hues, our collection of dark wood mouldings will help complement traditional décor or bring a unique natural feel to a piece of artwork.

Key ranges include the warm browns and wonderfully textured patterns of Navarra and the natural tones of the Simplicity range.



Moulding used
439 000 499

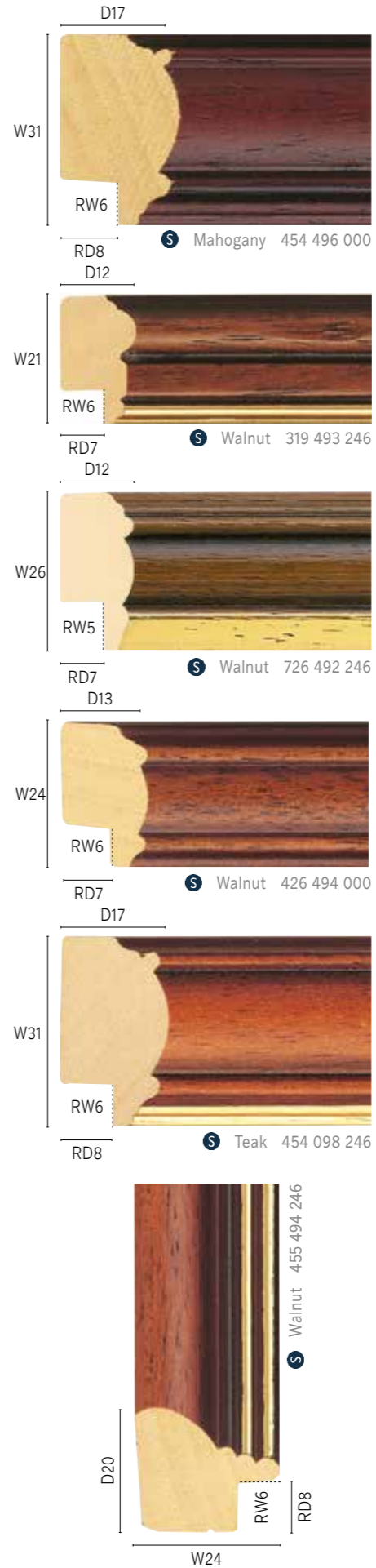
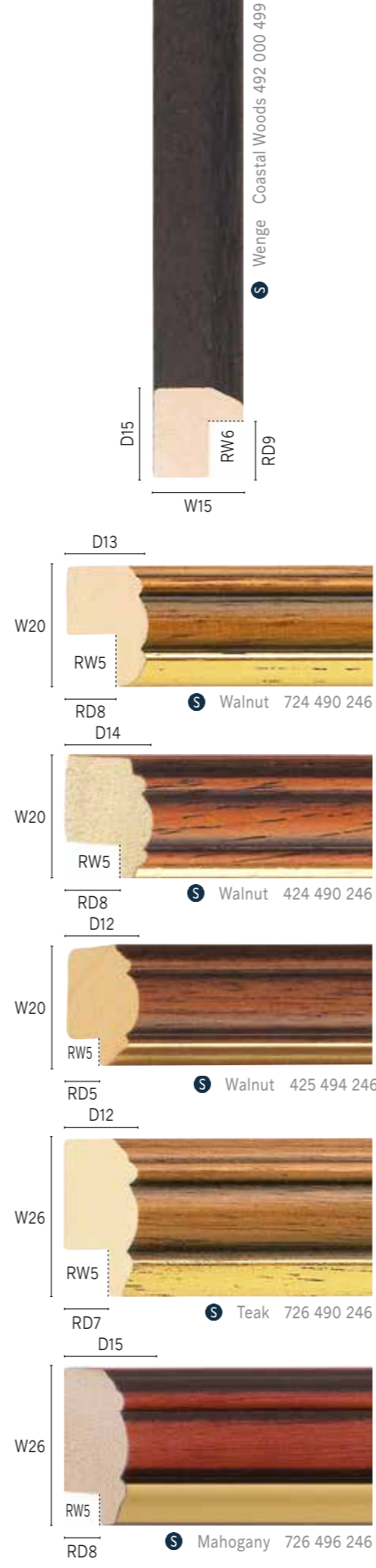
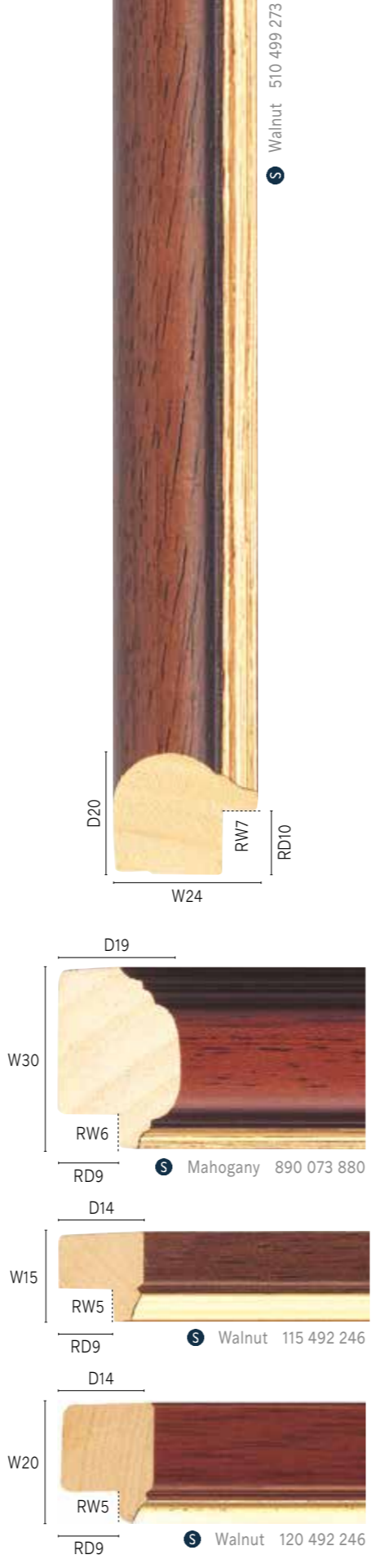
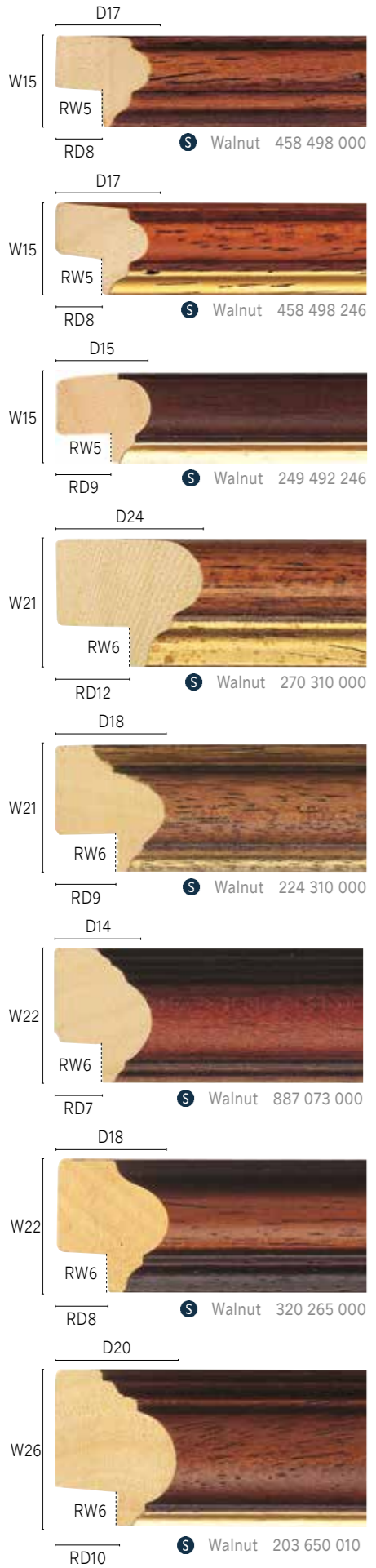



Walnut 116 011 000



Medium Oak 271 310 000



Mahogany 898 073 880



Dark Oak 293 033 000



Dark Wood 293 310 000



Walnut 720 225 246



Walnut 320 225 246



Medium Oak 235 033 000

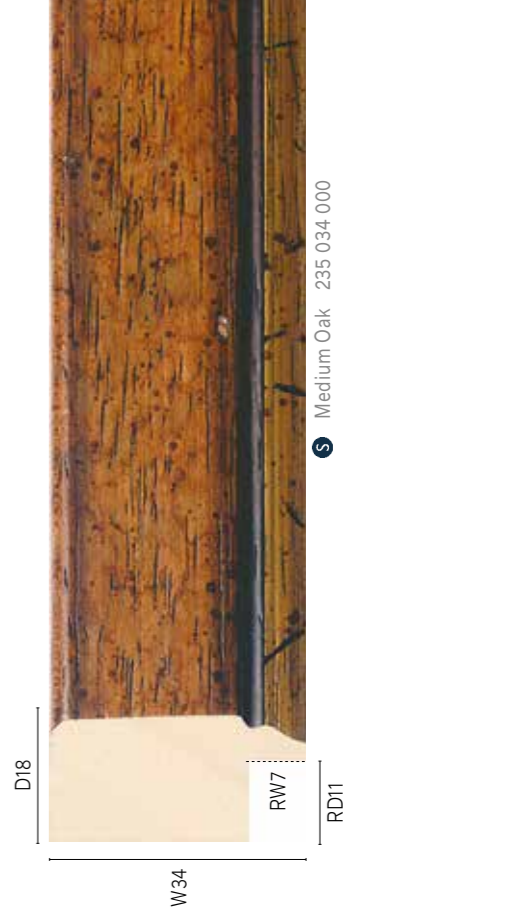

Medium Oak 235 034 000



Medium Oak 245 033 000



Medium Oak 245 034 000

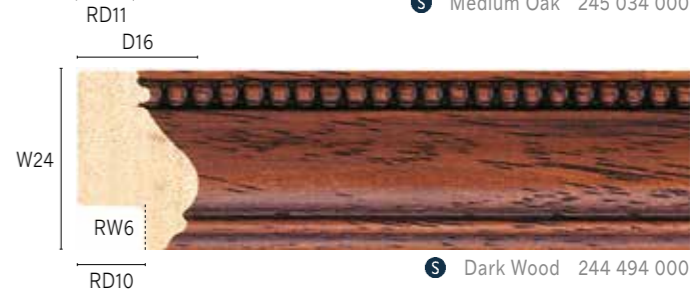

Dark Wood 244 494 000

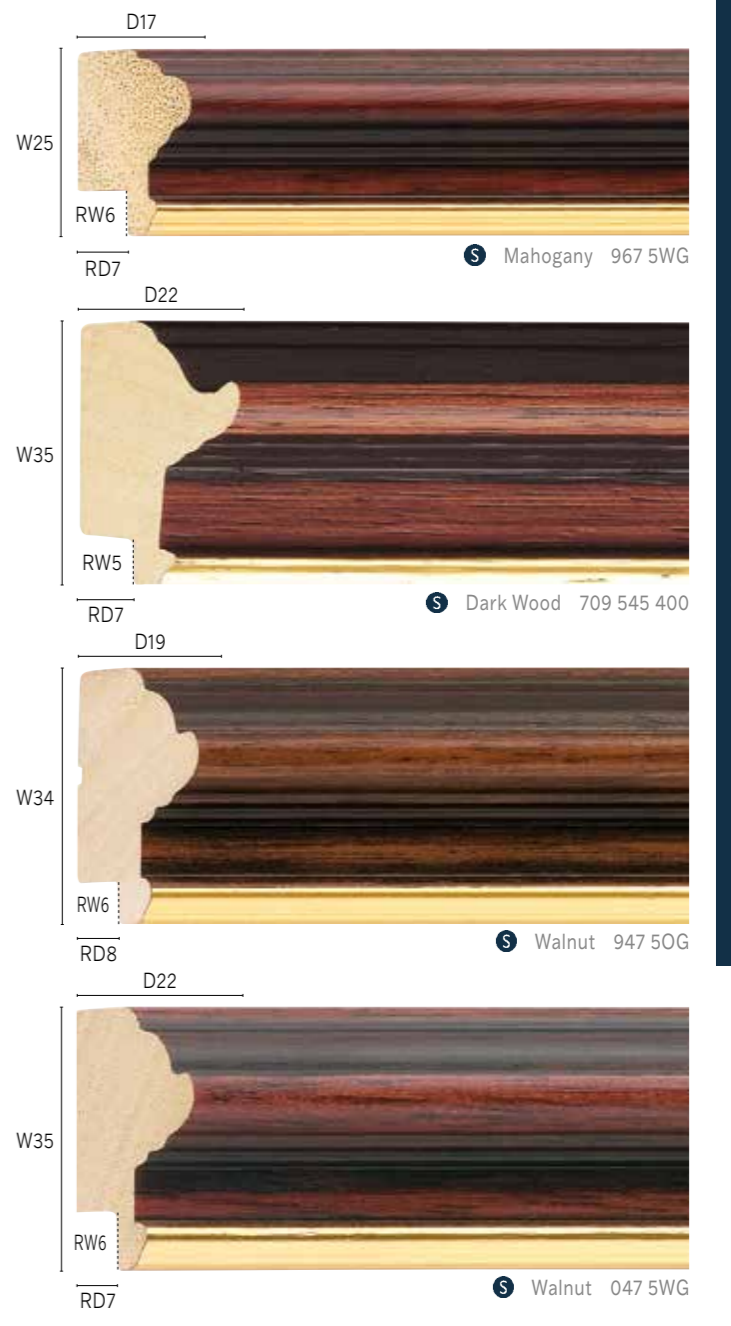
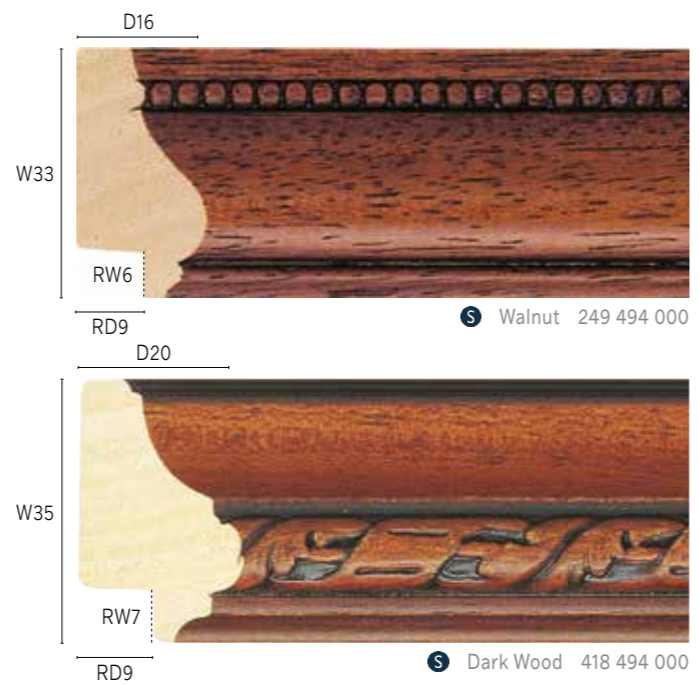
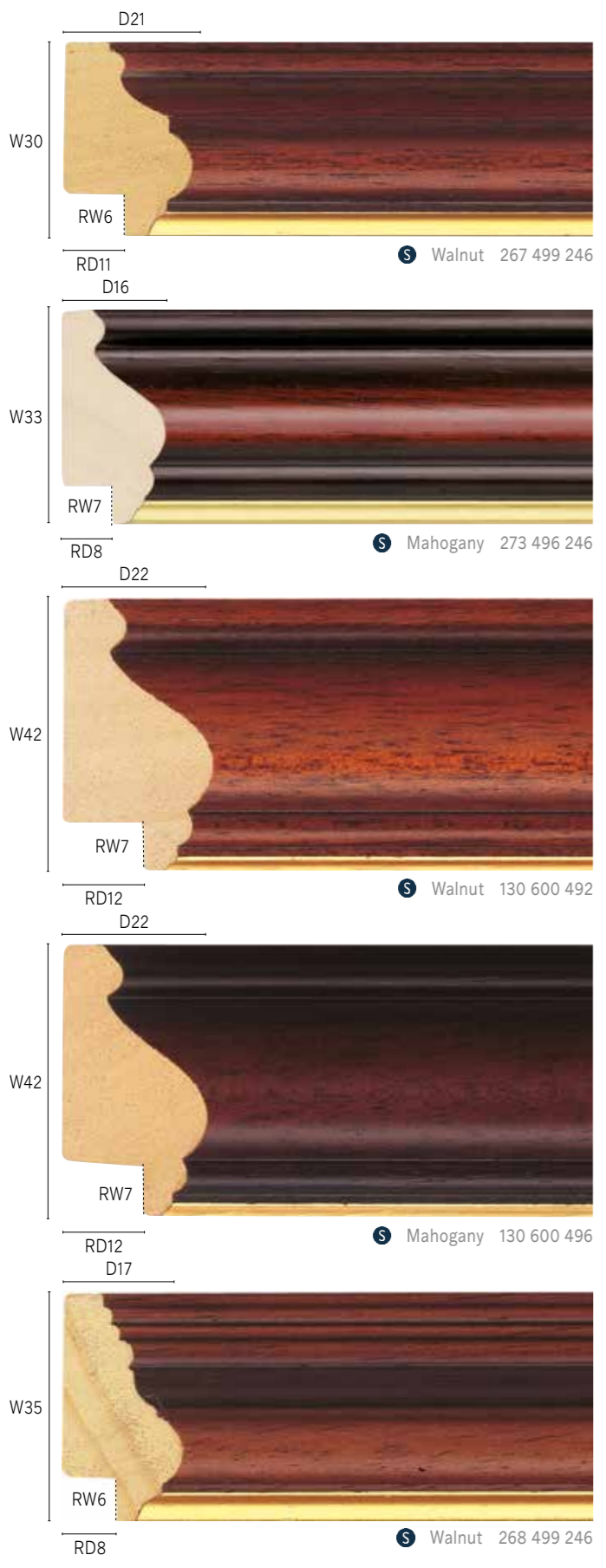

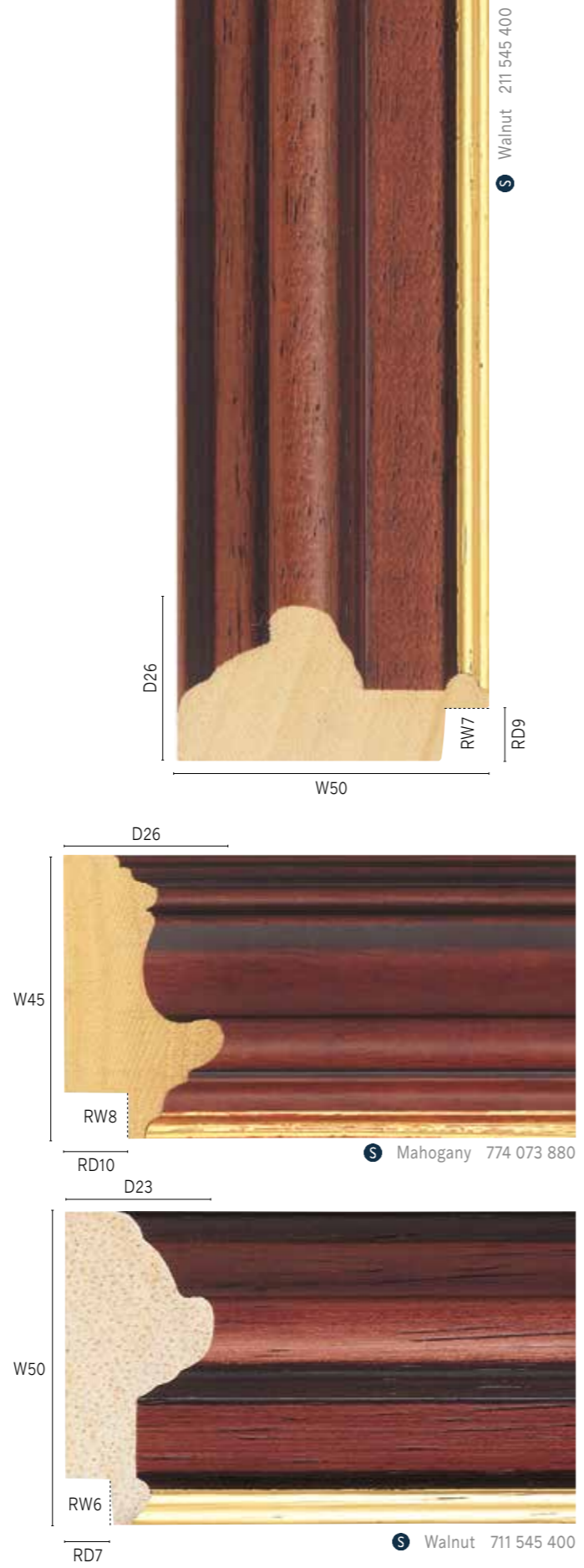

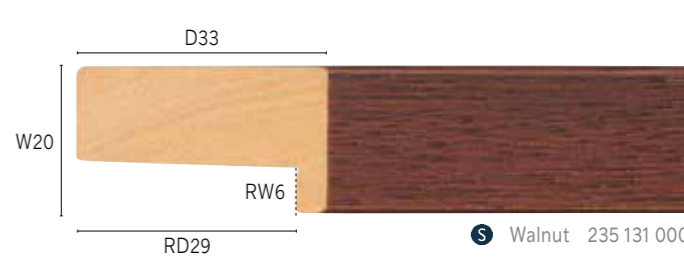
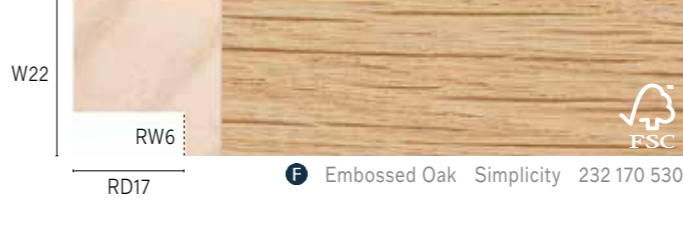
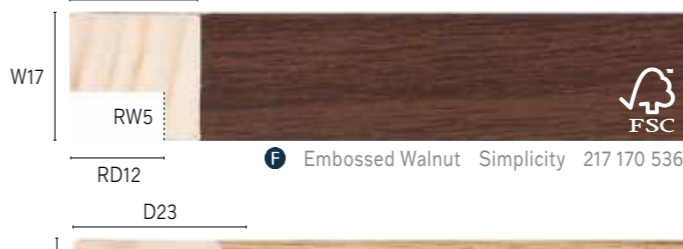
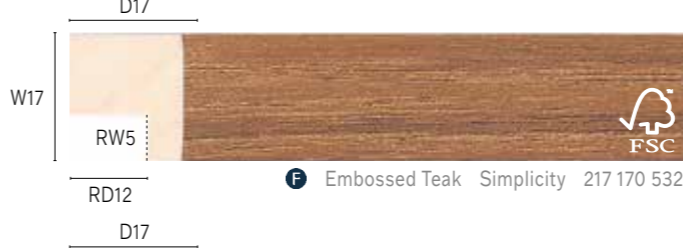
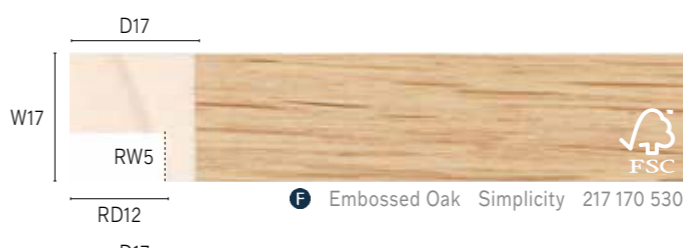

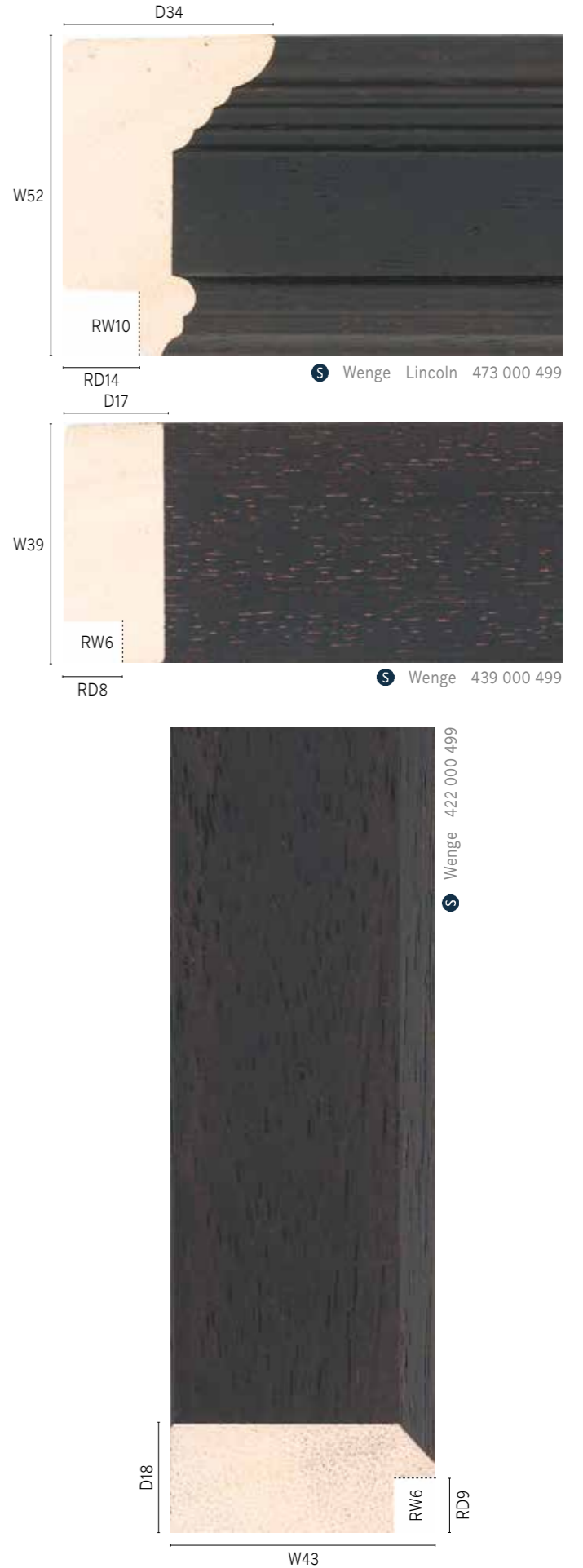
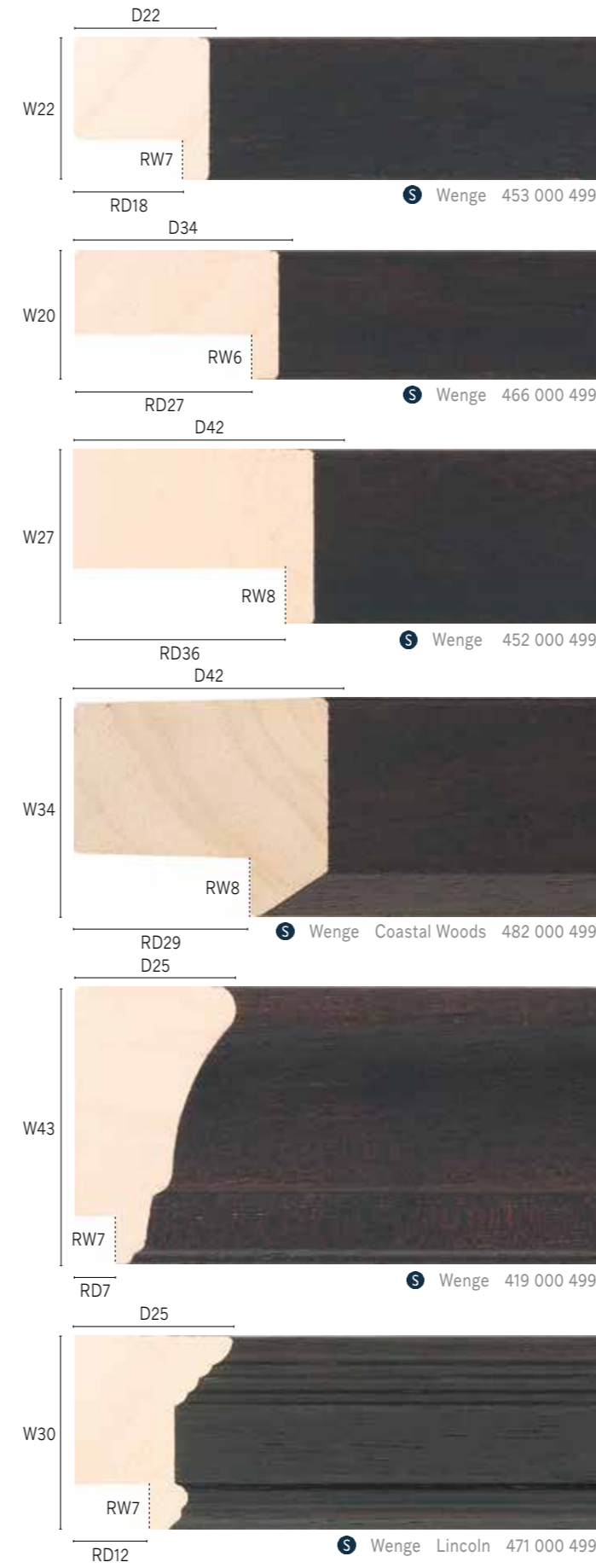
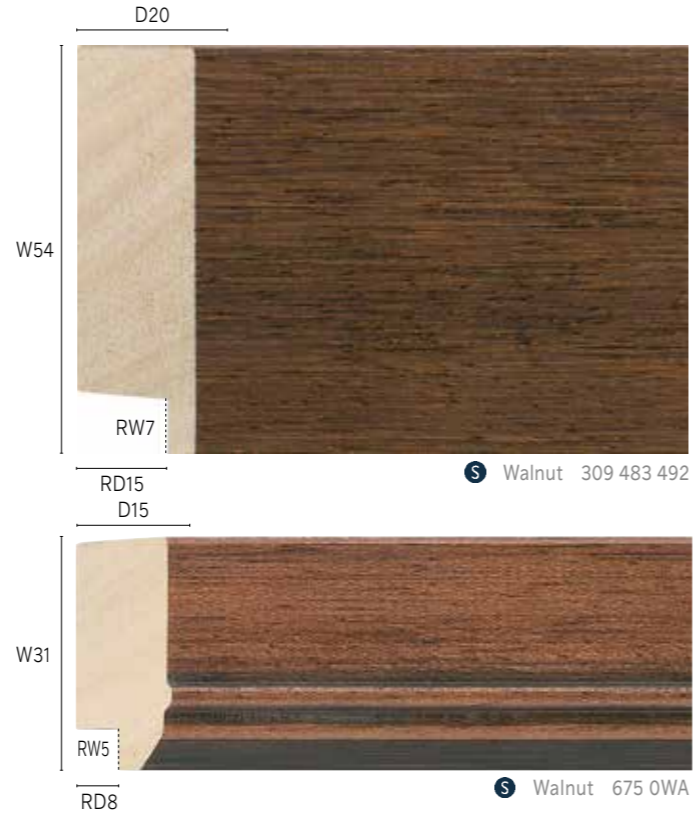

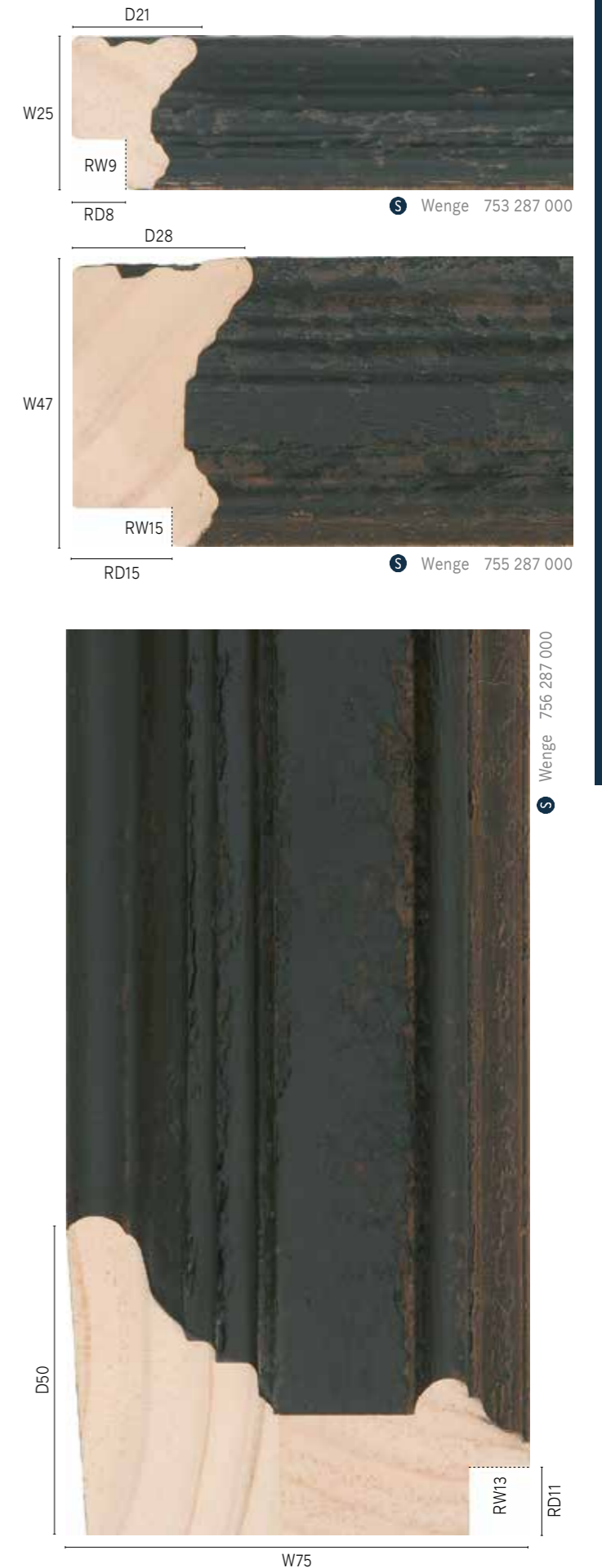

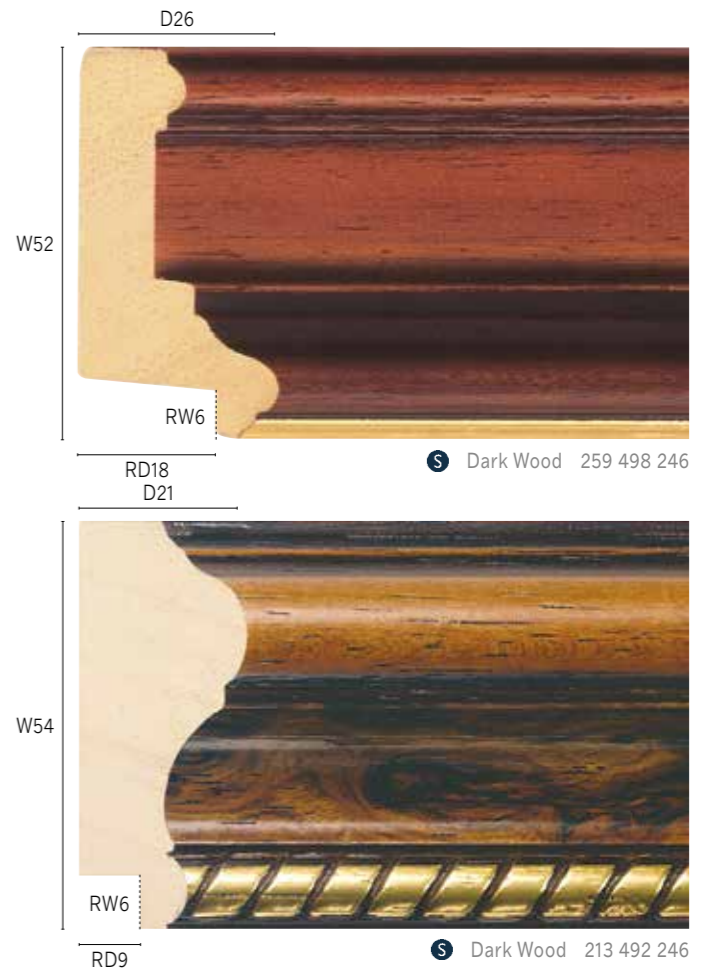

D35

W56



RW7

RD14 D47

Dark Wood 224 494 246

W87



RW16

RD17 D40

Brown/Grey 768 567 000

W84



RW10

RD17

Wenge Coastal Woods 241 000 499



D44

W105



RW6

RD20

Medium Oak Verdi 911 091

Natural Wood Veneers and Real Wood Veneers



Our Natural Wood Veneers give the opportunity to capture the unfinished or Nordic look, to the cutting edge profiles of our TouchWood range, designed to appeal to interior designers.

Natural Wood Veneers



Moulding used

991 116 115

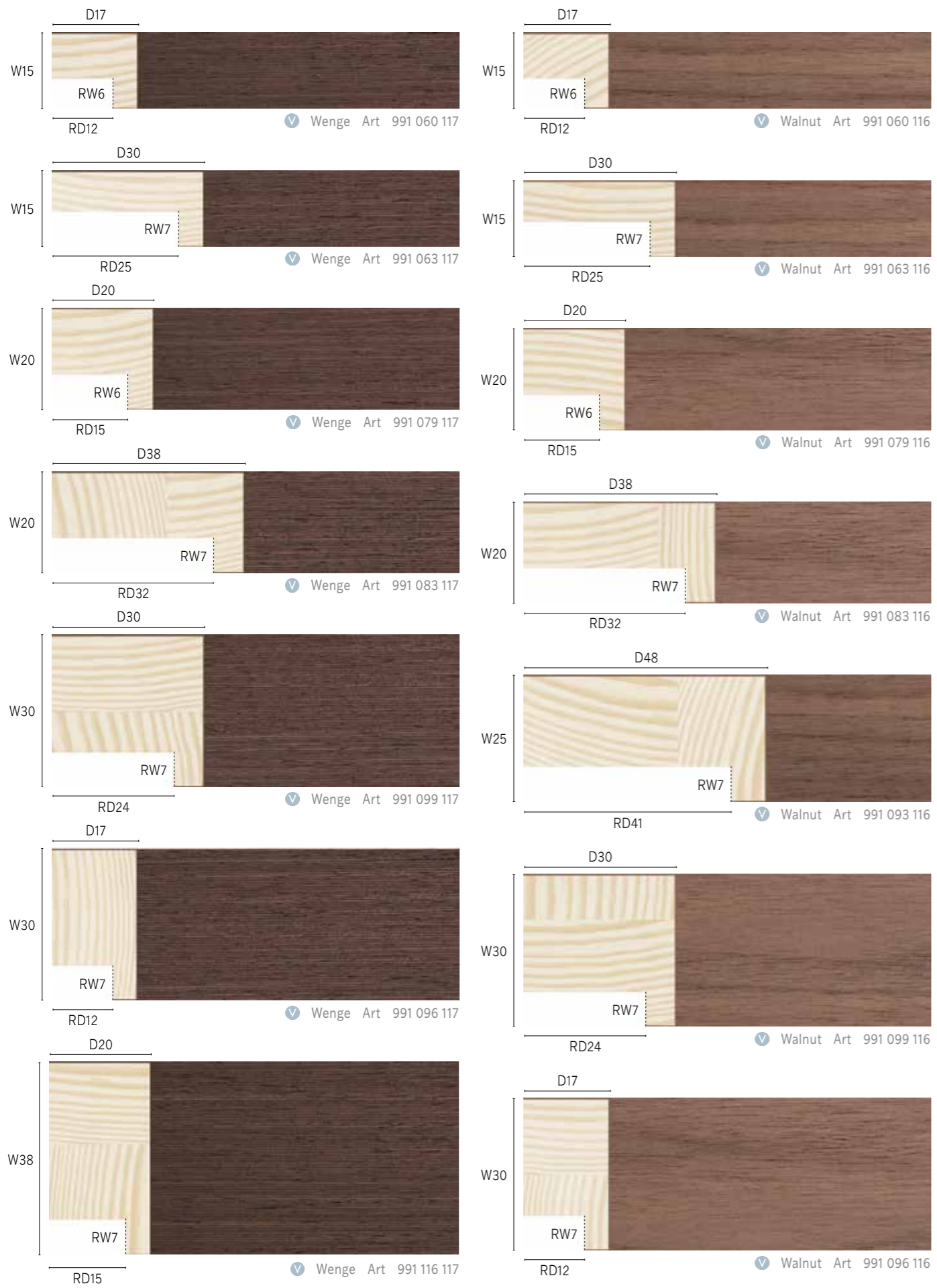

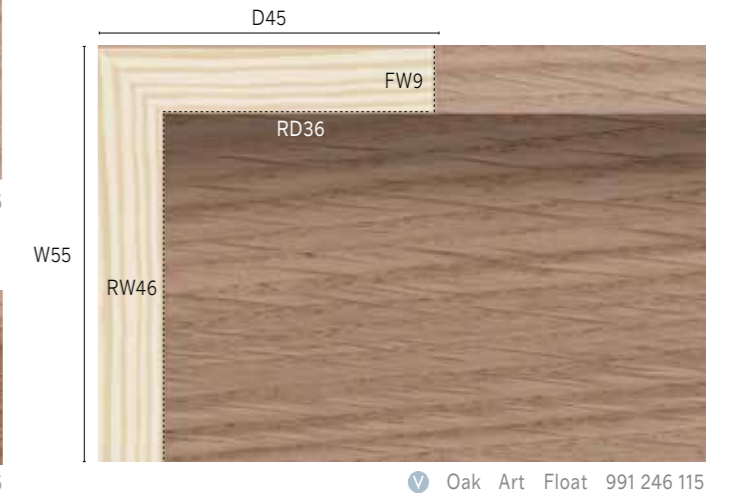
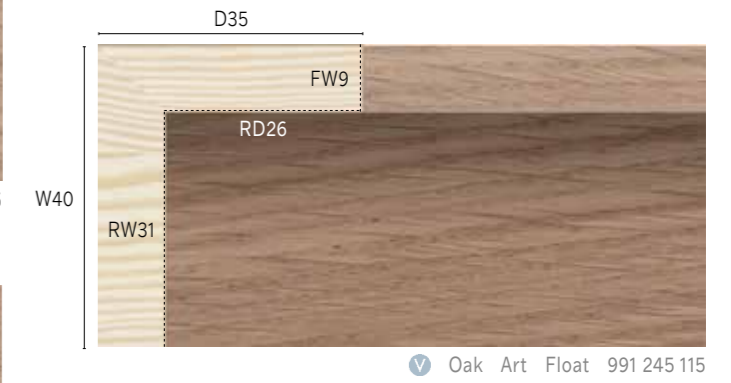
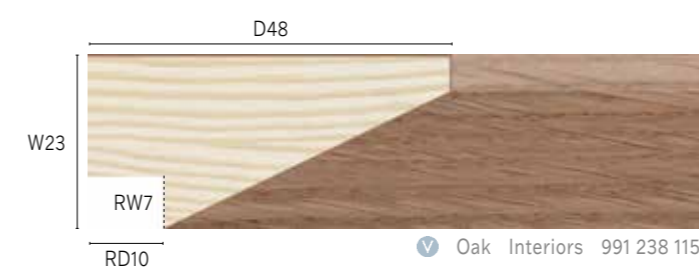
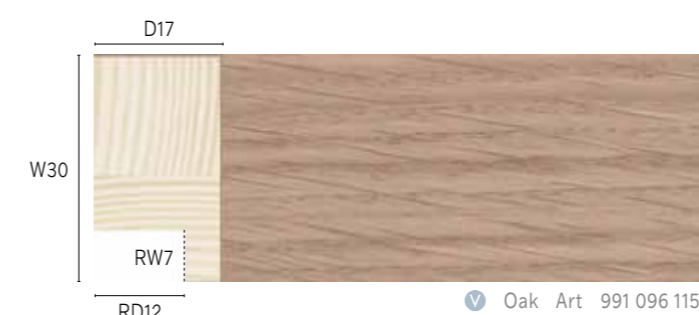
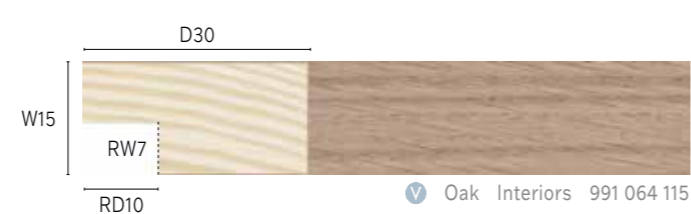

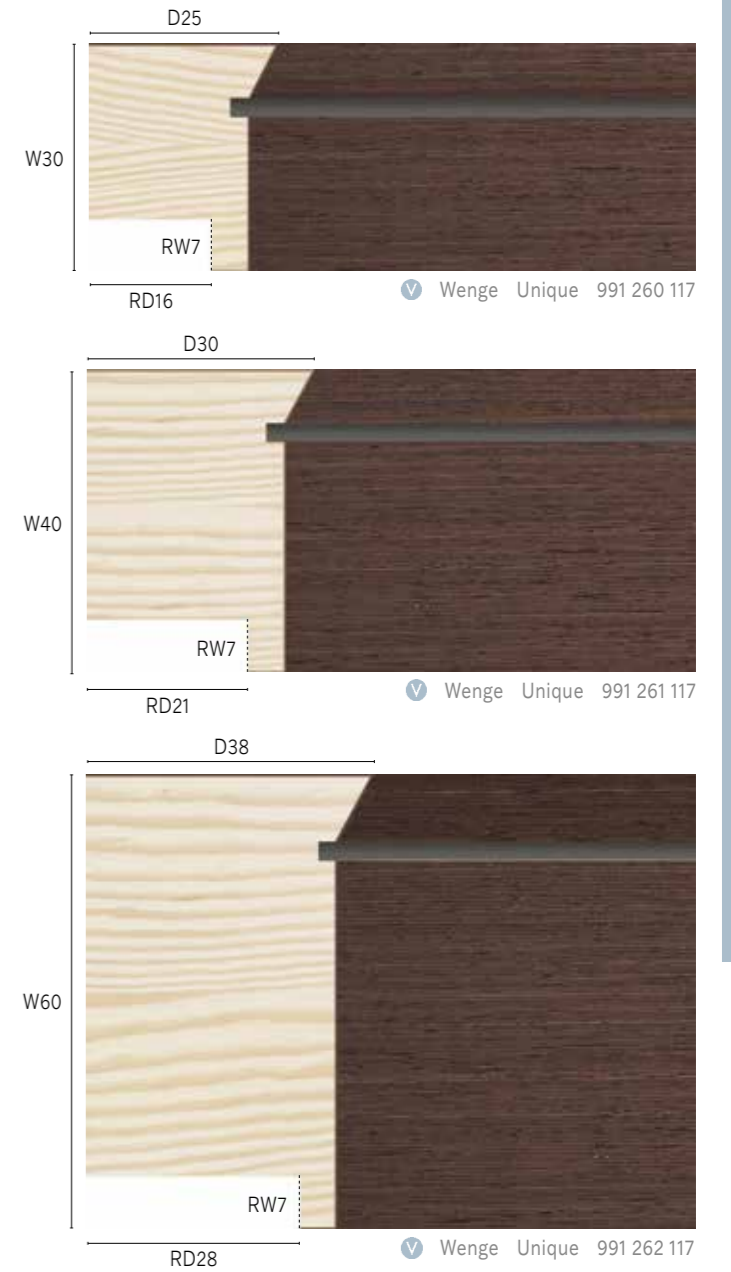

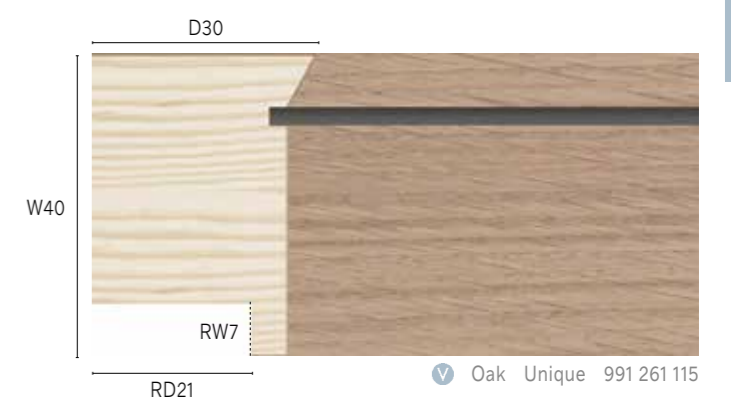
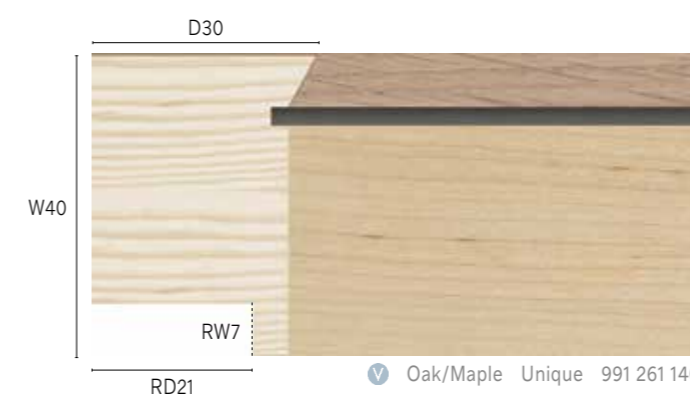
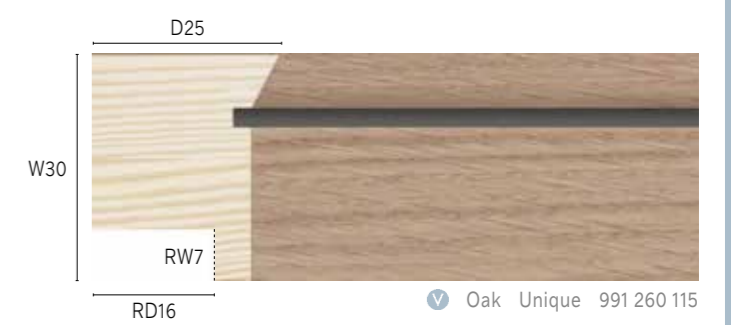
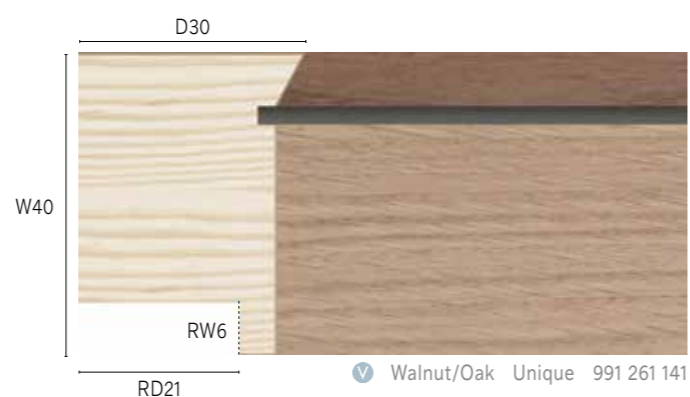
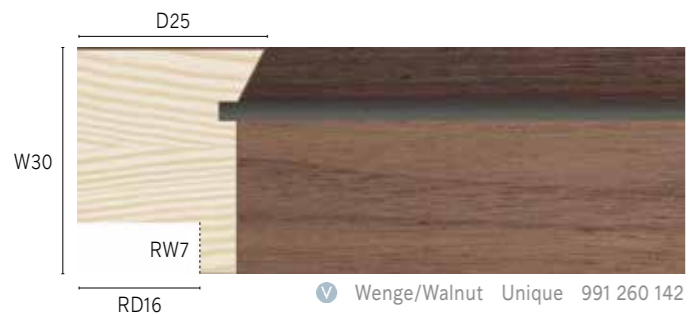
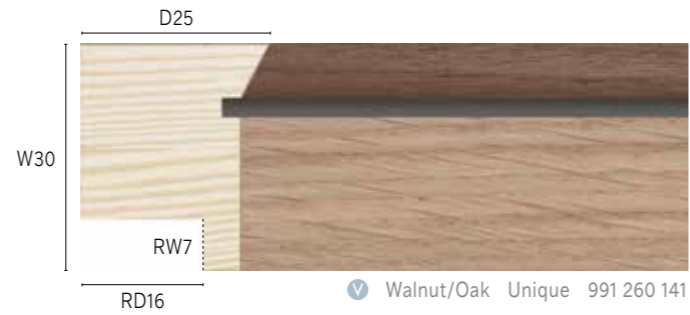
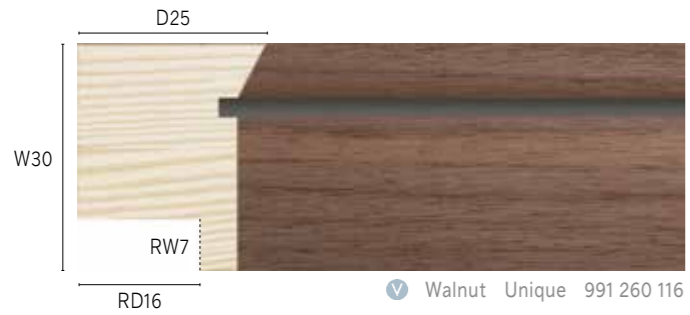

Real Wood Veneers

Veneers

Available in teak, light teak and walnut, we offer a selection of real wood veneer mouldings, some of which feature a lacquered finish.



Moulding used
322 422 000

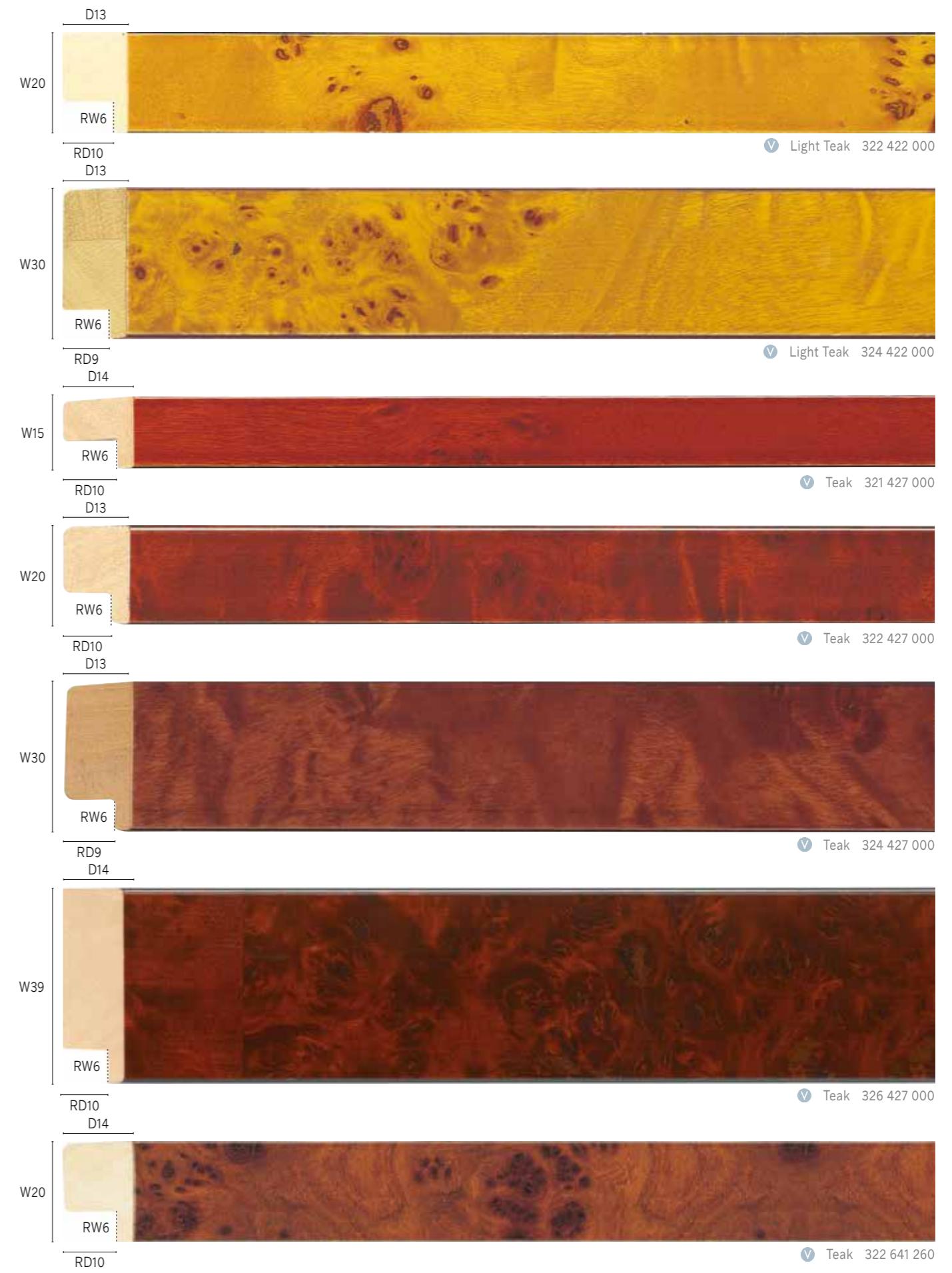

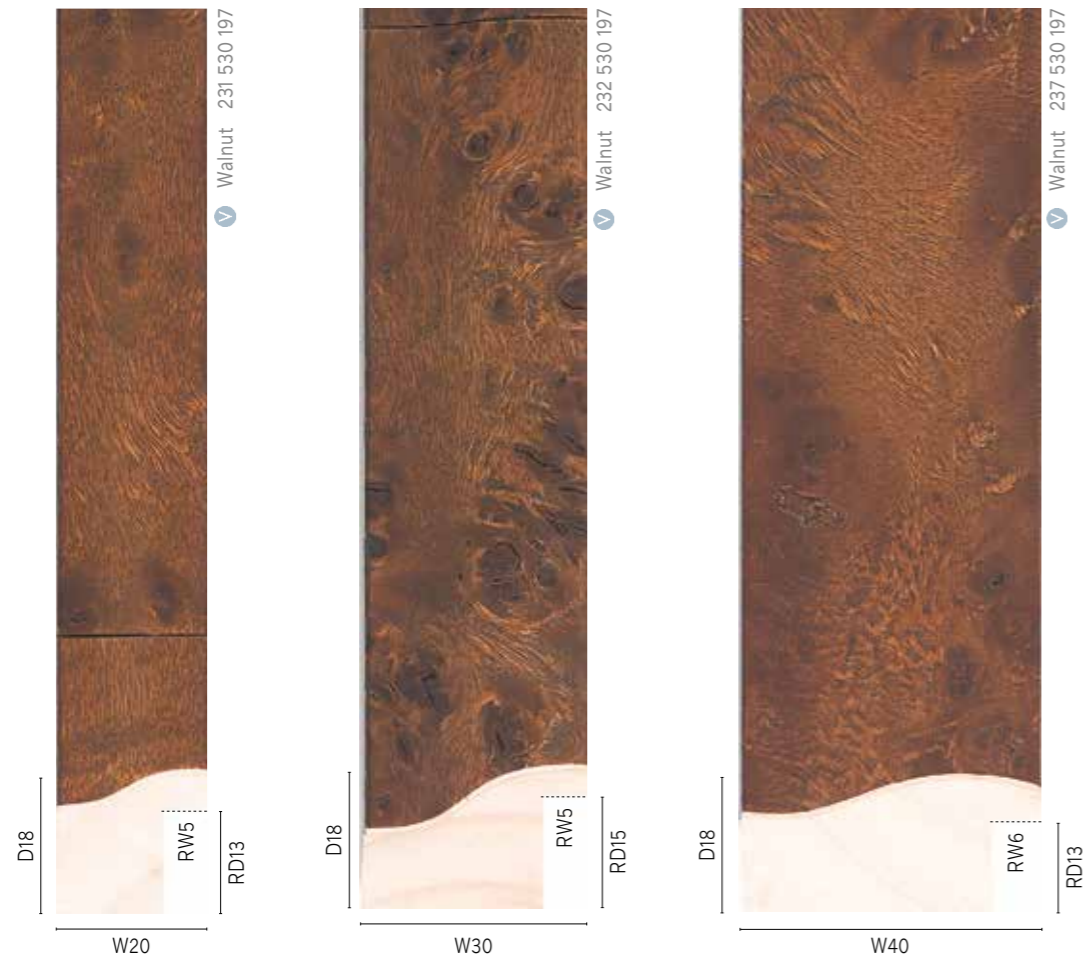
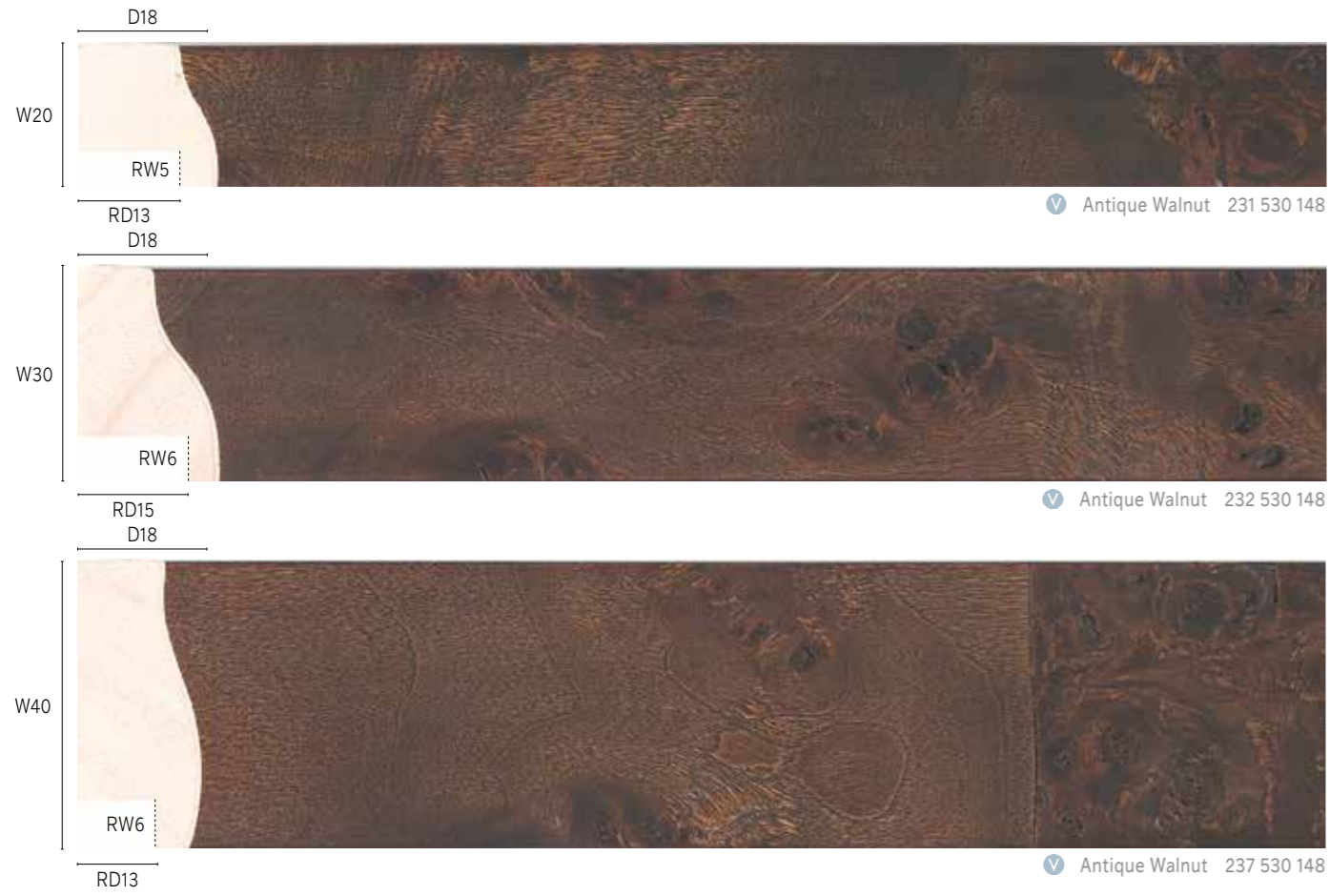

Whitewashed/ Natural and Honey Pine

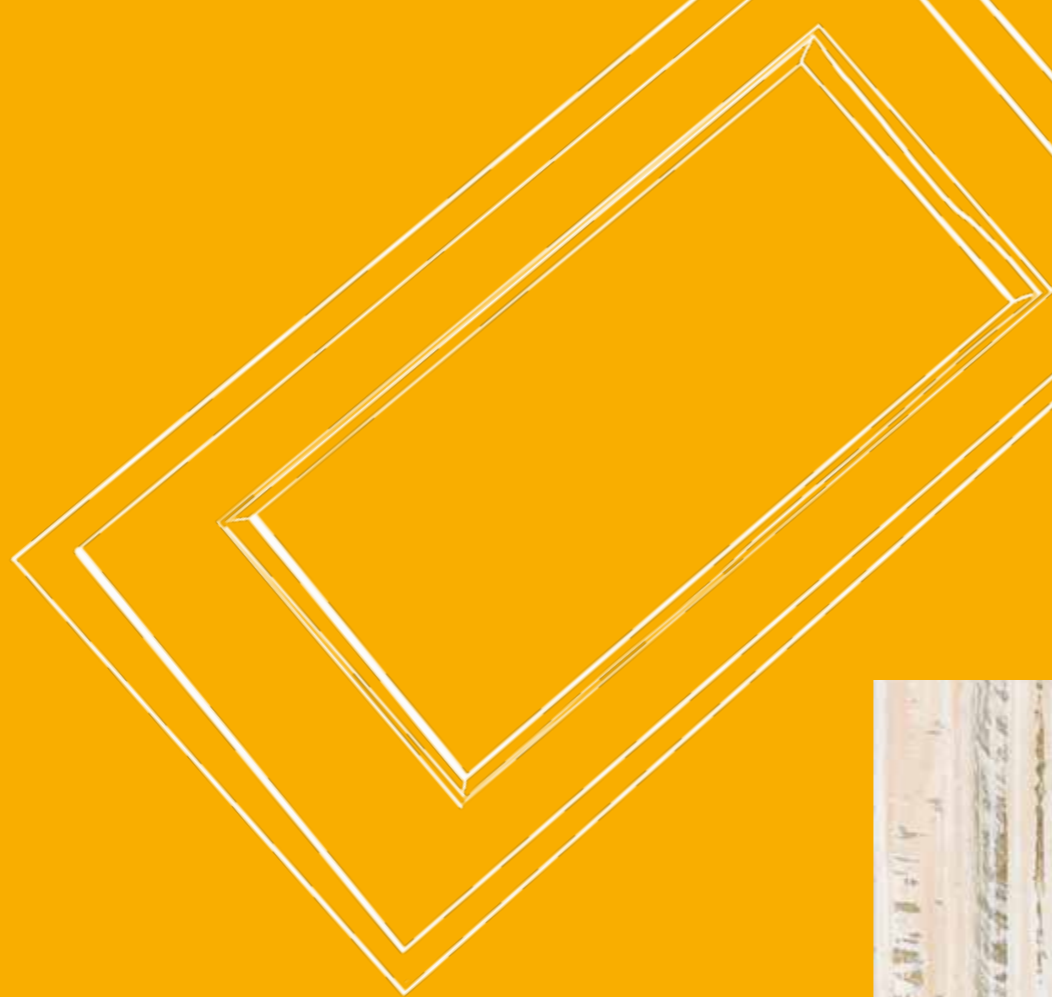

Whitewashed/ Natural and Honey Pine

The softer tones of light wood are perfect for achieving a natural and eco-conscious look. We offer a wide selection of light wood mouldings from the Coastal to the Simplicity range.



Moulding used
756 257 000



<p>D17</p> <p>W17</p> <p>RW5</p> <p>RD12</p> <p>F Maple Simplicity 217 170 540</p>	<p>D17</p> <p>W17</p> <p>RW5</p> <p>RD12</p> <p>F Whitewashed Oak Simplicity 217 170 541</p>
<p>D30</p> <p>W19</p> <p>RW6</p> <p>RD25</p> <p>F Maple Simplicity 219 170 540</p>	<p>D30</p> <p>W19</p> <p>RW6</p> <p>RD25</p> <p>F Whitewashed Oak Simplicity 219 170 541</p>
<p>D23</p> <p>W22</p> <p>RW6</p> <p>RD17</p> <p>F Maple Simplicity 232 170 540</p>	<p>D23</p> <p>W22</p> <p>RW6</p> <p>RD17</p> <p>F Whitewashed Oak Simplicity 232 170 541</p>
<p>D30</p> <p>W30</p> <p>RW7</p> <p>RD24</p> <p>F Maple Simplicity 233 170 540</p>	<p>D30</p> <p>W30</p> <p>RW7</p> <p>RD24</p> <p>F Whitewashed Oak Simplicity 233 170 541</p>
<p>D17</p> <p>W40</p> <p>RW7</p> <p>RD12</p> <p>F Maple Simplicity 240 170 540</p>	<p>D17</p> <p>W40</p> <p>RW7</p> <p>RD12</p> <p>F Whitewashed Oak Simplicity 240 170 541</p>



<p>D15</p> <p>W20</p> <p>RW6</p> <p>RD8</p> <p>S Ivory Coastal Woods 219 000 137</p>	<p>D34</p> <p>W20</p> <p>RW6</p> <p>RD27</p> <p>S Cream Coastal Woods 466 000 137</p>
<p>D22</p> <p>W22</p> <p>RW7</p> <p>RD18</p> <p>S Ivory Coastal Woods 453 000 137</p>	<p>D13</p> <p>W20</p> <p>RW6</p> <p>RD9</p> <p>S Ivory 303 423 157</p>
<p>D17</p> <p>W17</p> <p>RW8</p> <p>RD12</p> <p>F Ivory Driftwood 217 170 985</p>	<p>D30</p> <p>W19</p> <p>RW8</p> <p>RD25</p> <p>F Ivory Driftwood 219 170 985</p>
<p>D23</p> <p>W22</p> <p>RW6</p> <p>RD18</p> <p>F Ivory Driftwood 232 170 985</p>	<p>D15</p> <p>W15</p> <p>RW6</p> <p>RD9</p> <p>S Ivory Coastal Woods 492 000 137</p>
<p>D16</p> <p>W28</p> <p>RW7</p> <p>RD11</p> <p>F Ivory Driftwood 250 281 985</p>	<p>D30</p> <p>W30</p> <p>RW6</p> <p>RD25</p> <p>F Ivory Driftwood 233 170 985</p>
<p>D17</p> <p>W40</p> <p>RW7</p> <p>RD12</p> <p>F Ivory Driftwood 240 170 985</p>	<p>D22</p> <p>W20</p> <p>RW6</p> <p>RD16</p> <p>S Ivory 114 300 157</p>
<p>D13</p> <p>W22</p> <p>RW5</p> <p>RD9</p> <p>S Ivory 242 31V</p>	

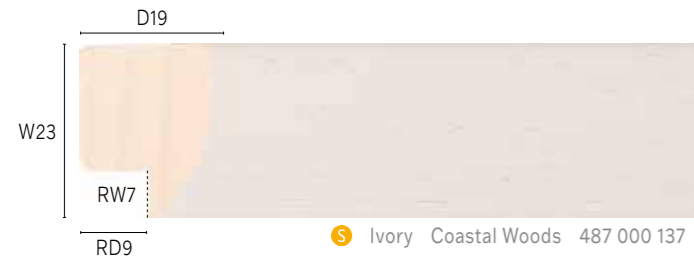

S Ivory Coastal Woods 487 000 137



S Beige Whitewashed 754 000 152

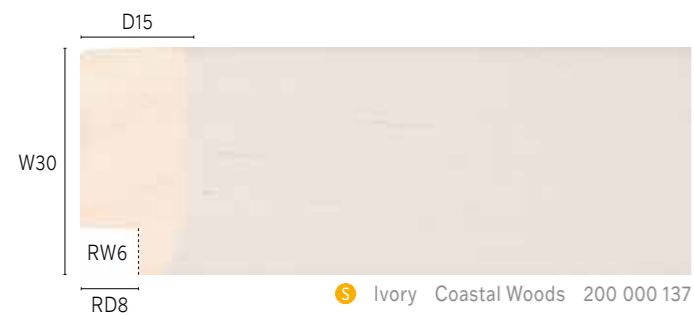

S Ivory Coastal Woods 200 000 137

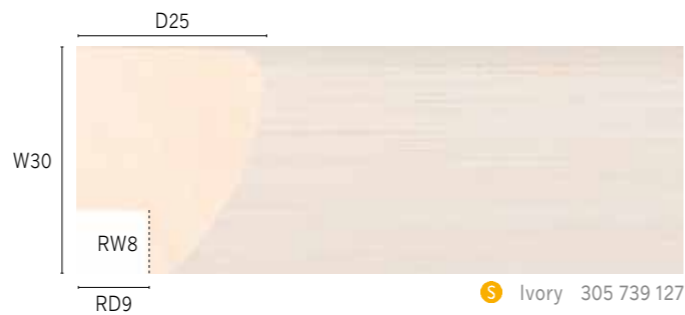

S Ivory 305 739 127

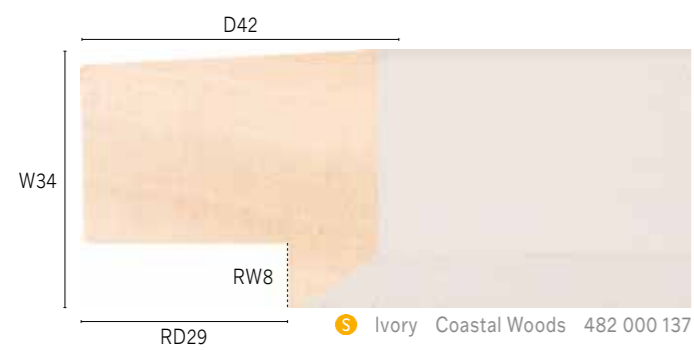

S Ivory Coastal Woods 482 000 137

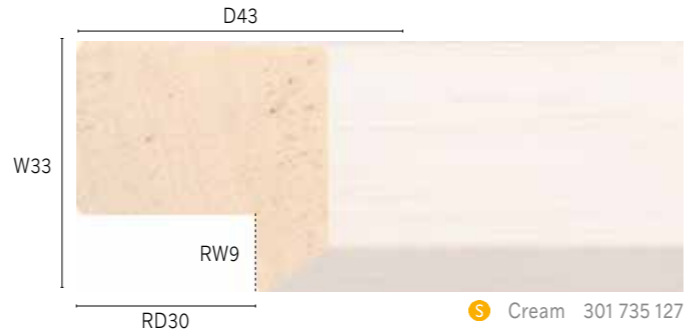

S Cream 301 735 127

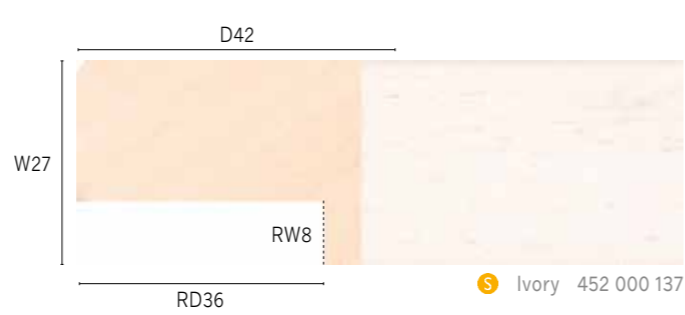

S Ivory 452 000 137



S Ivory Coastal Woods 439 000 137



S Ivory Coastal Woods 256 000 137



S Ivory Coastal Woods 419 000 137



S Ivory 302 443 157

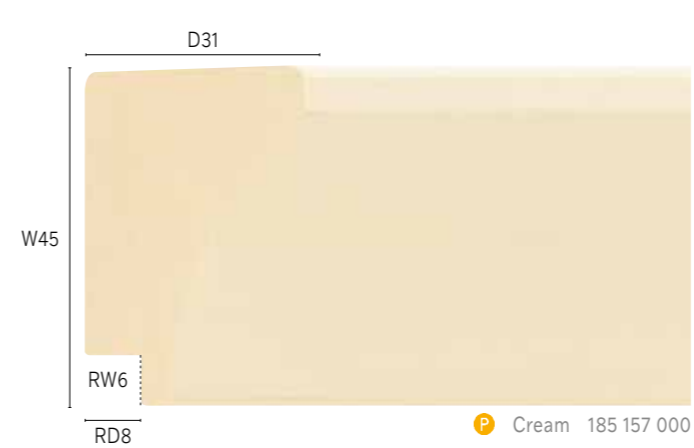

P Cream 185 157 000

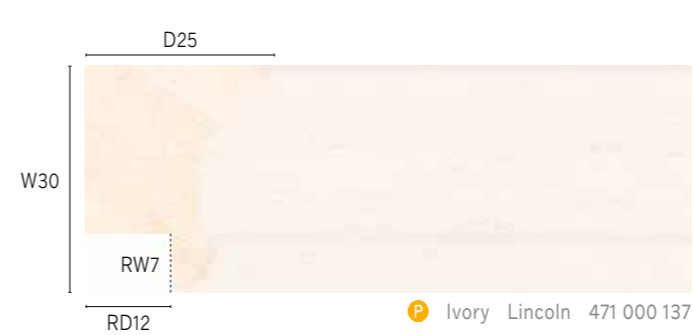

P Ivory Lincoln 471 000 137

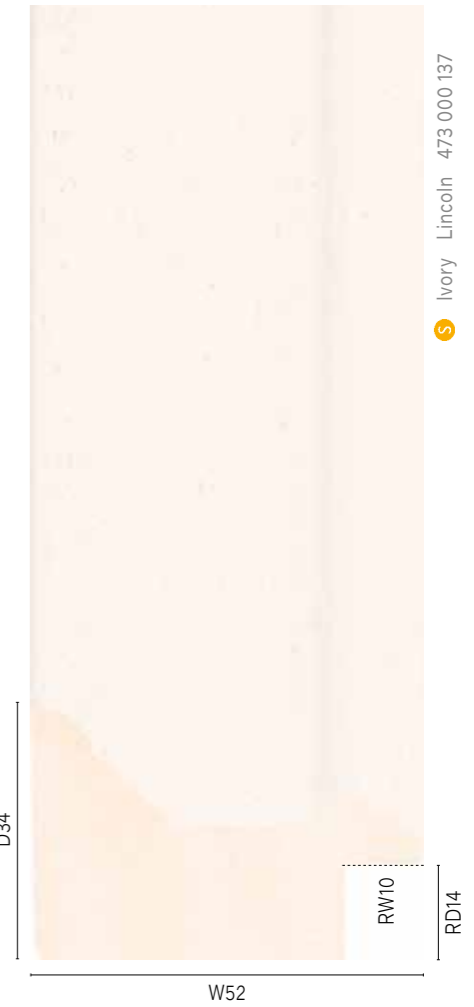

S Ivory Lincoln 473 000 137



S Ivory Coastal Woods 422 000 137



S Ivory Coastal Woods 185 000 137



S Cream 302 736 127

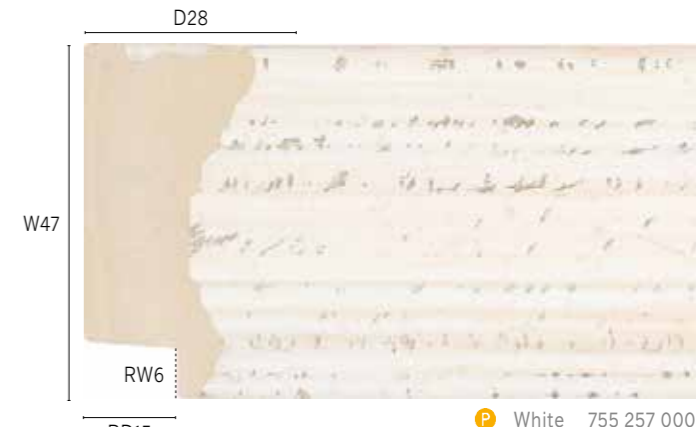
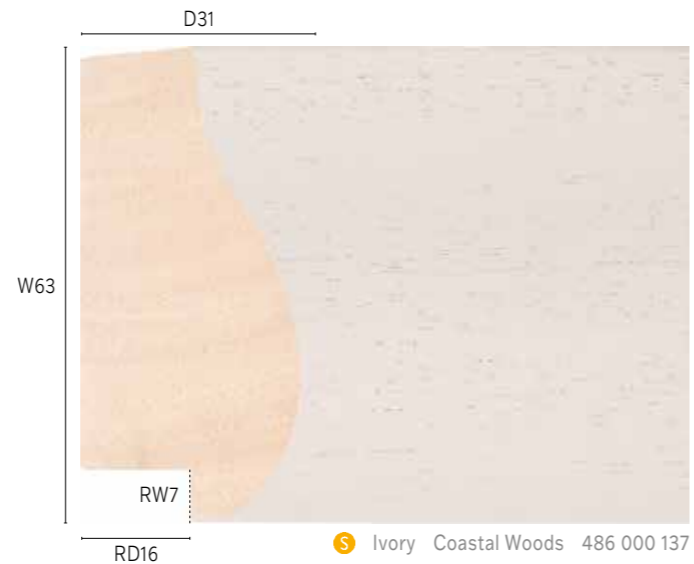
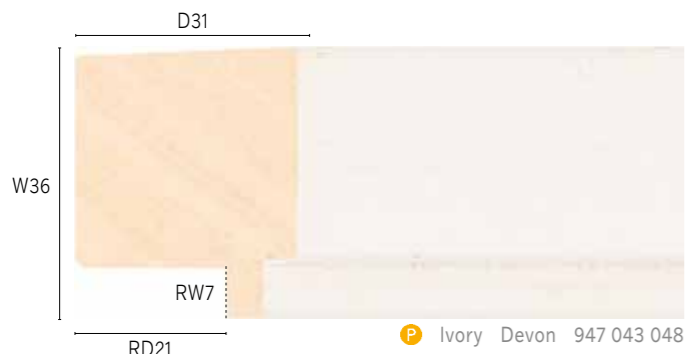

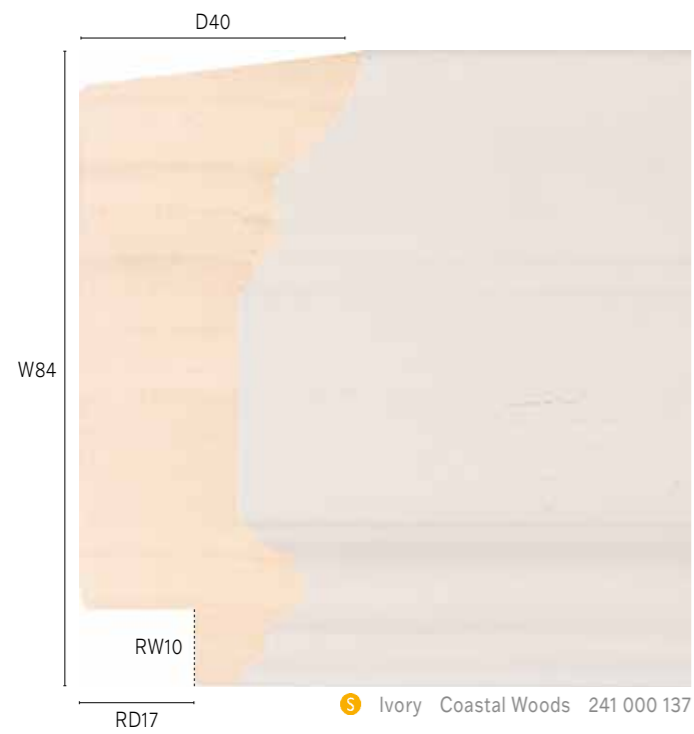
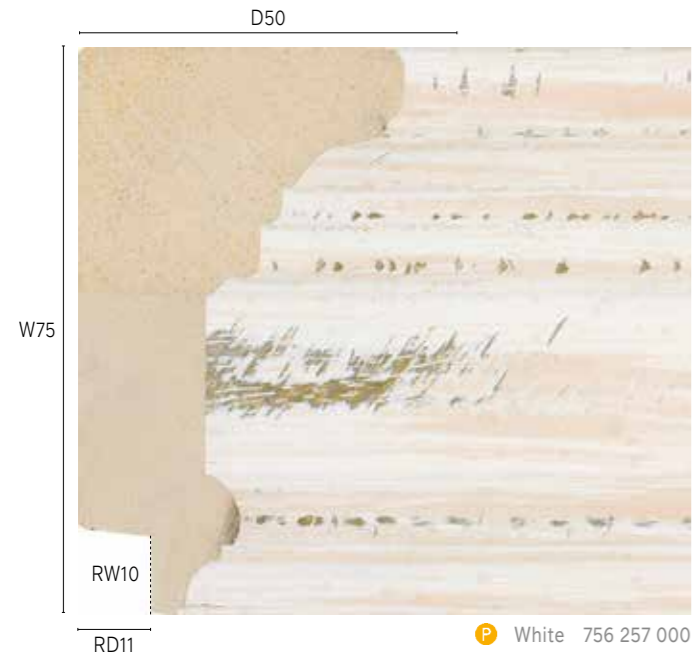

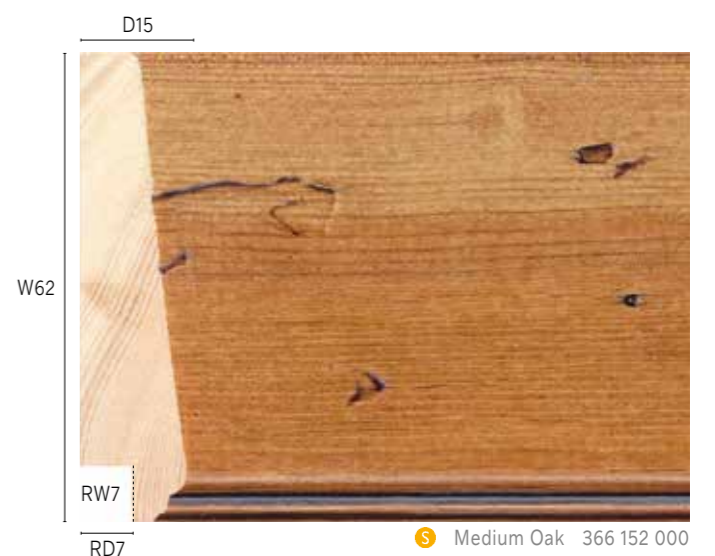
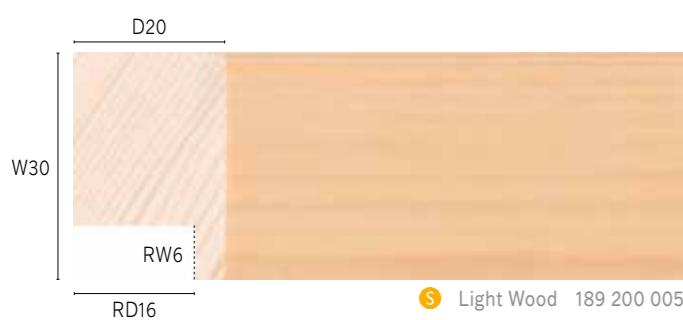
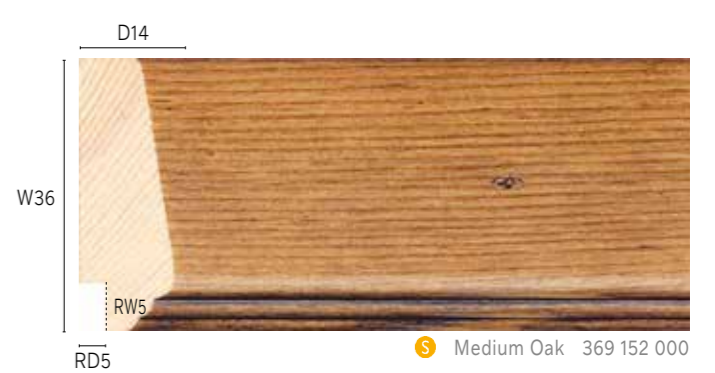
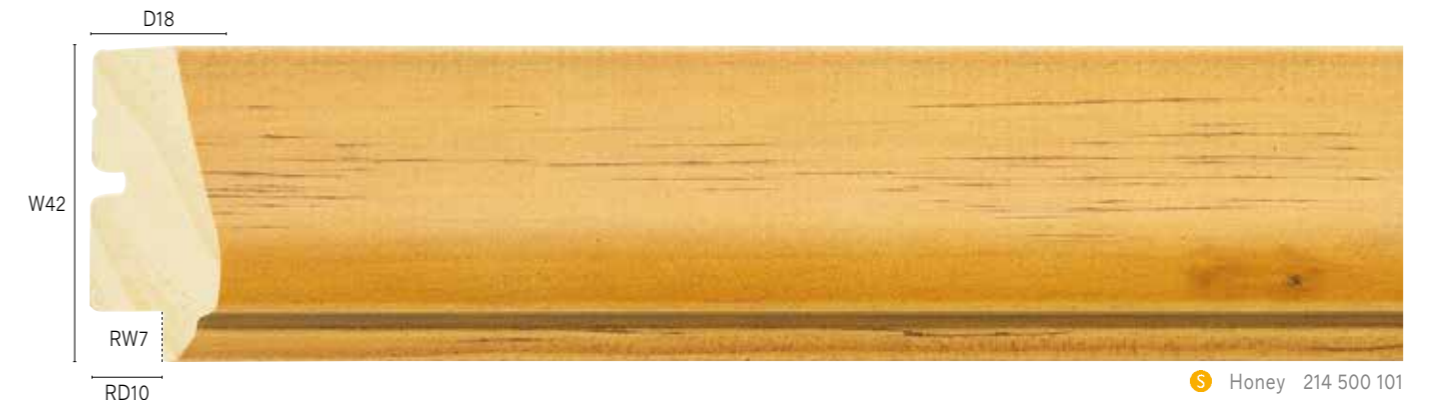
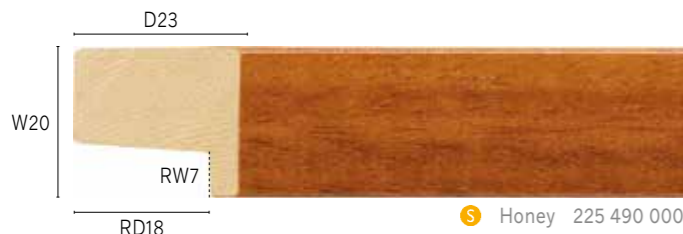

Barefaced!

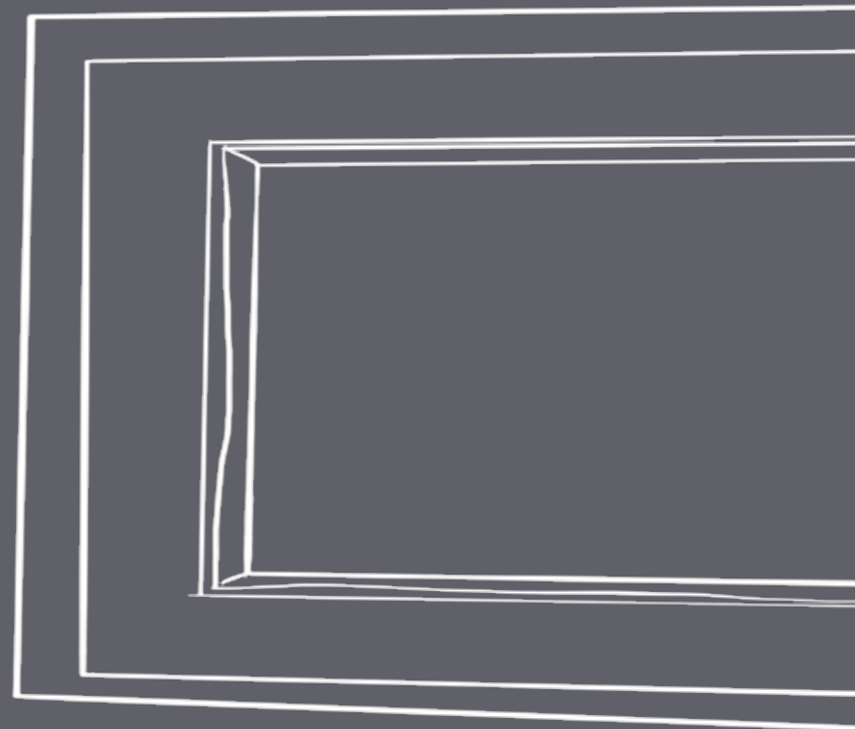

Barefaced!

When you want the simplicity and elegance of natural wood, our Barefaced! mouldings give you a wide range of options. Woods include Ash, Beech, Oak, Obeche, Pine, Lime and Tulip. Also included are many canvas stretcher profiles including Arrow-Head.



Moulding used
121 300 000

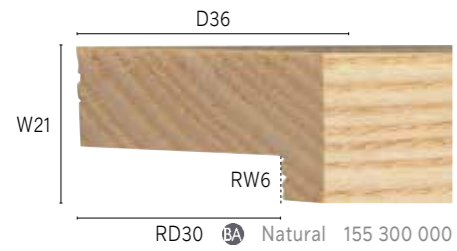
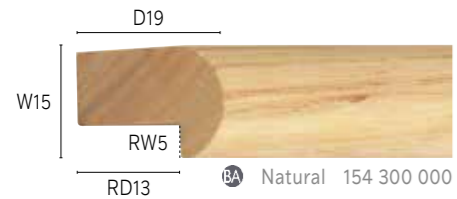

Natural 113 300 000

D14 W20 RW6 RD9

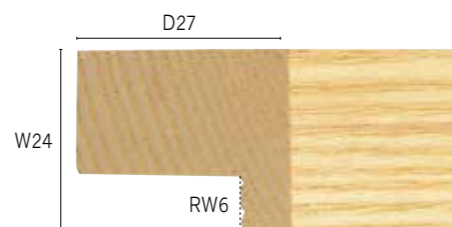
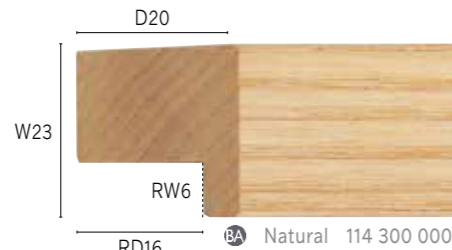

RD22 Natural 103 300 000



RD13 Natural 180 300 000



RD9 Natural 390 300 000

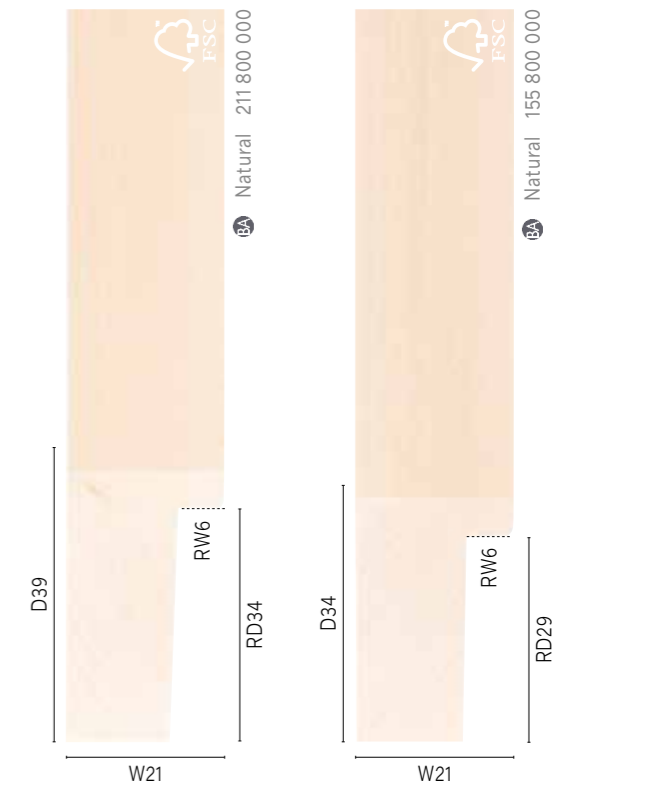
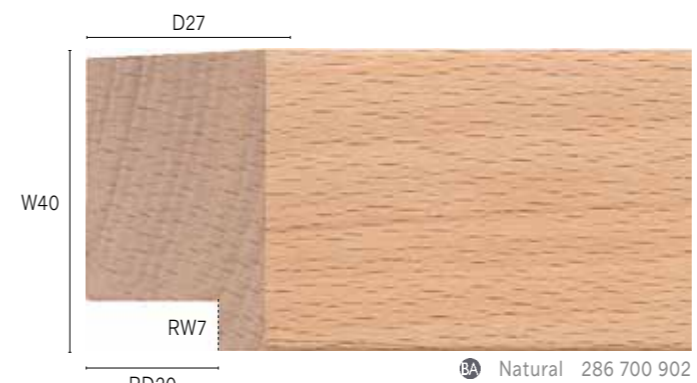
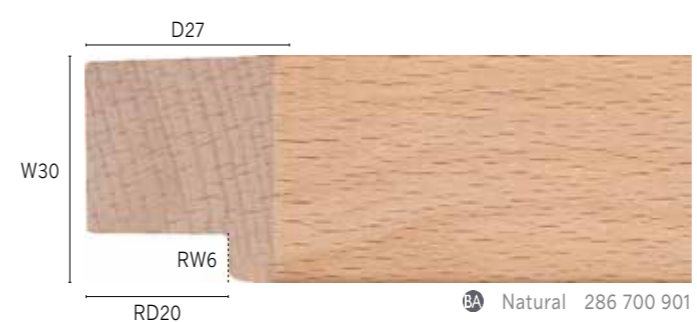
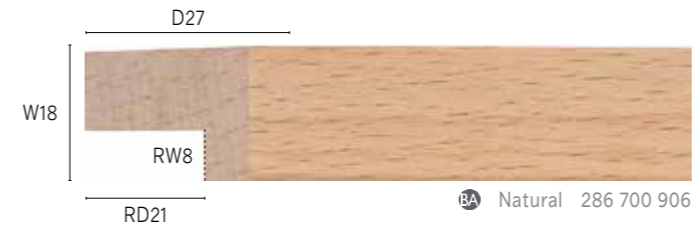
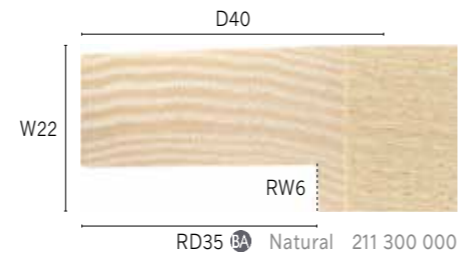
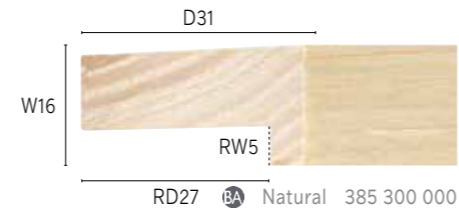

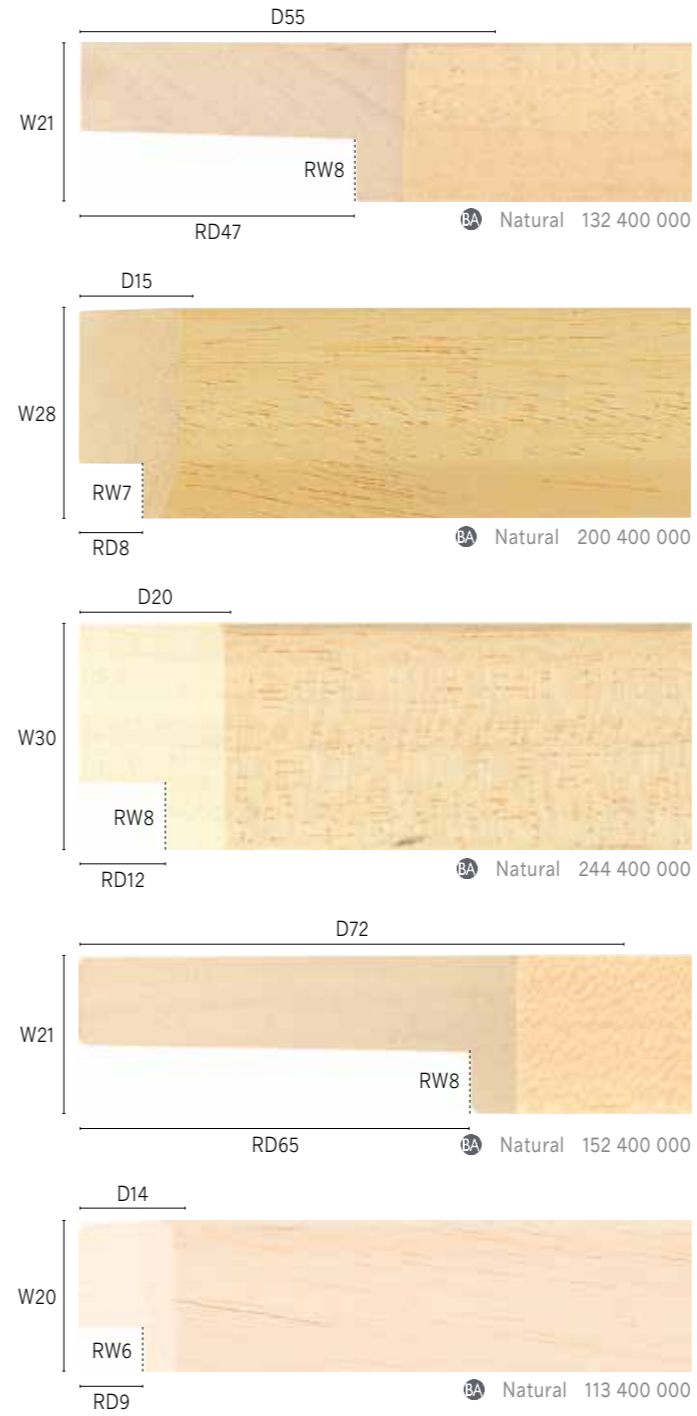
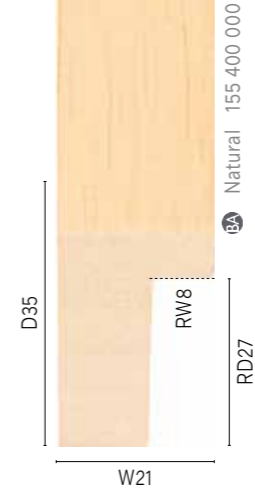

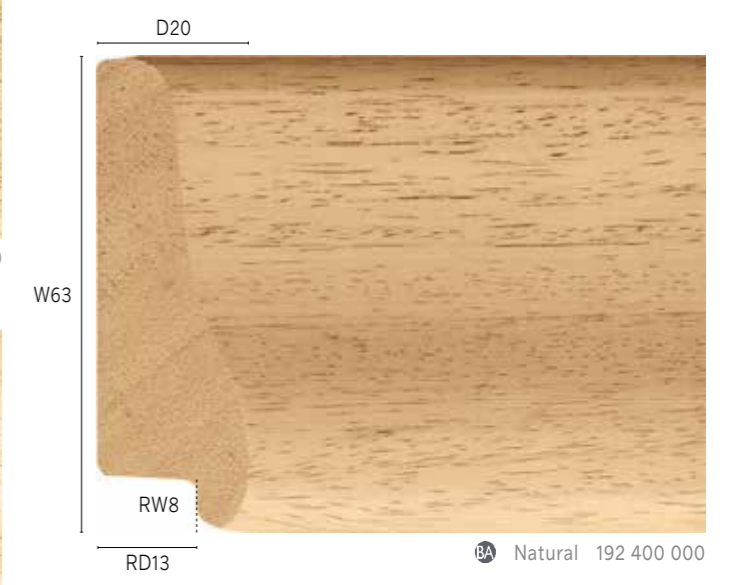
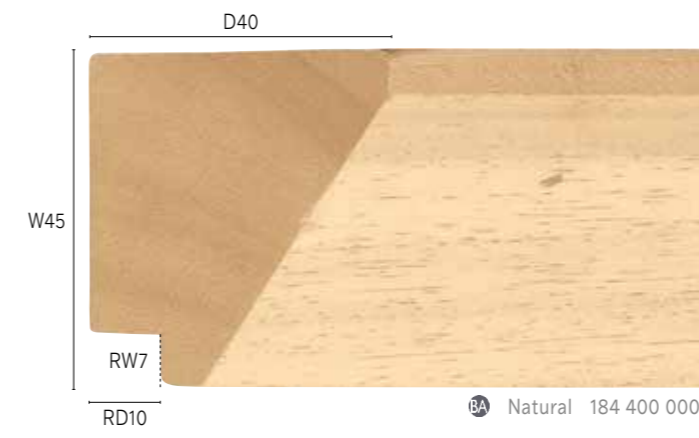

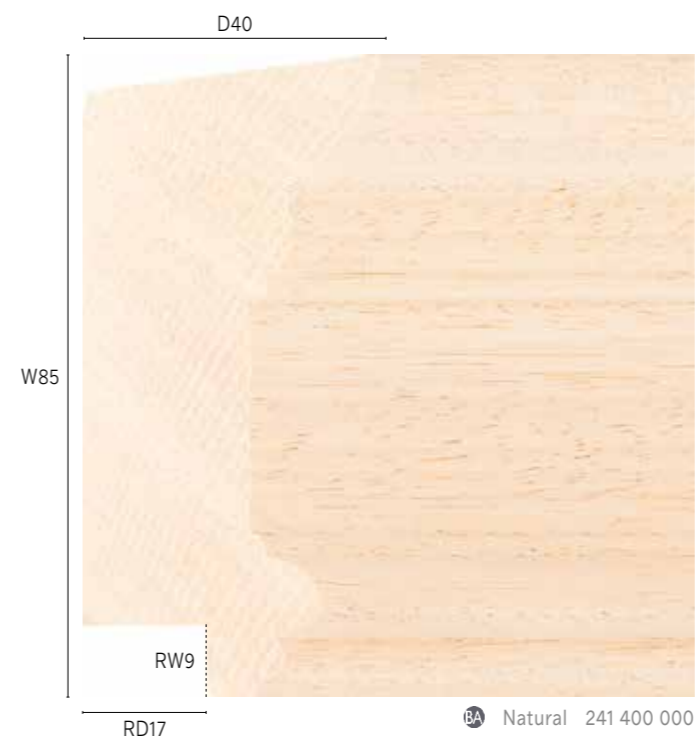
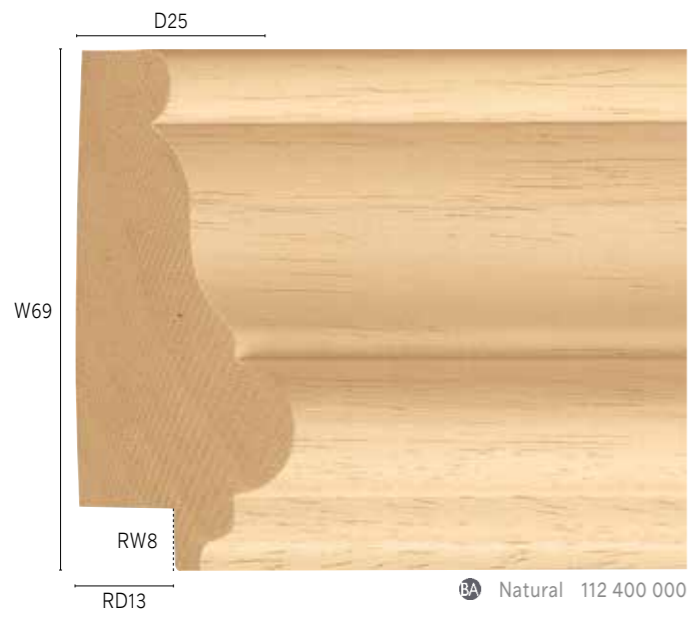



FrameBox® allows any 3-dimensional item to be framed quickly and simply

FrameBox® eliminates the need for deep rebate frames, which can be expensive and limited in size.

With FrameBox®, any depth can be achieved, allowing those previously 'impossible' items to be framed quickly, easily and at a more affordable cost.

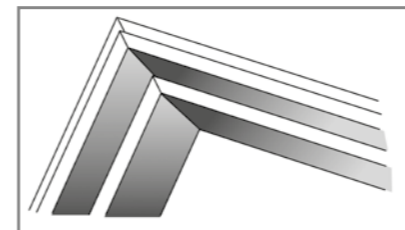
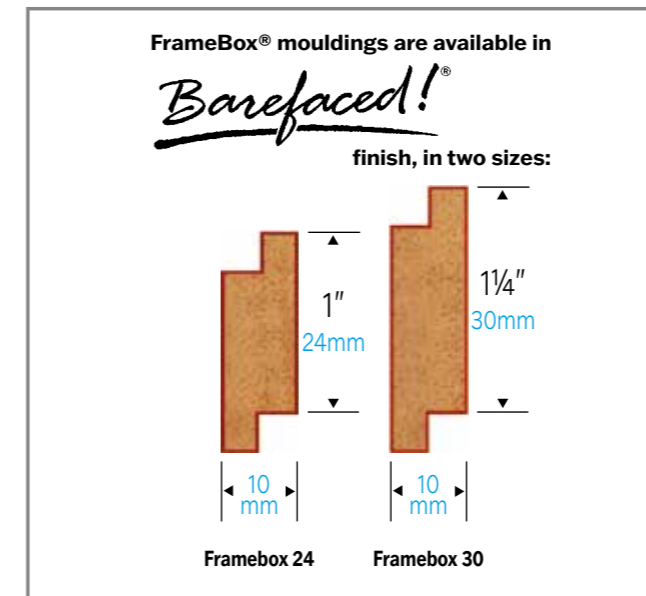

Flip FrameBoxes® to create a reducing perspective effect.

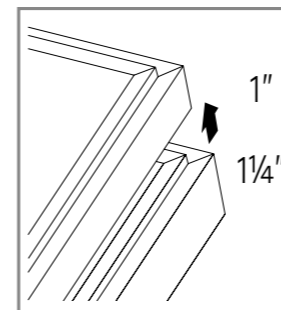

Use two or more in any combination to create special size FrameBoxes®

Hints and Advice

- For a permanent fitting, FrameBox® may be secured in place using PVA wood glue.
- A silicone sealant is recommended for the easier removal of your FrameBox® at a later date.

This unique product allows the framer to add a deep box to any picture frame - using exactly the same equipment to mitre and underpin that they already use to make an ordinary frame - and can accommodate items of varying depth:

- 3D Decoupage Paper Sculpture
- Wedding Bouquets
- Butterflies
- Decorative Plates and Thimbles
- Collectors Items
- Sugarcraft
- Medals and Coins
- Special Editions
- Hole-in-One Golf Balls
- Dried Flower Arrangements
- Models - Dinky Toys

FrameBox® turns any frame into a Deep Box Frame

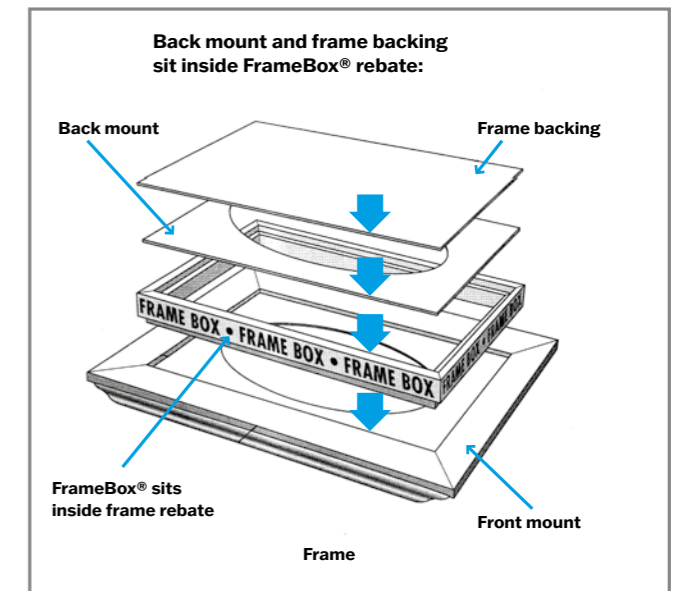

The FrameBox® logo and design are protected by Registered Patent.

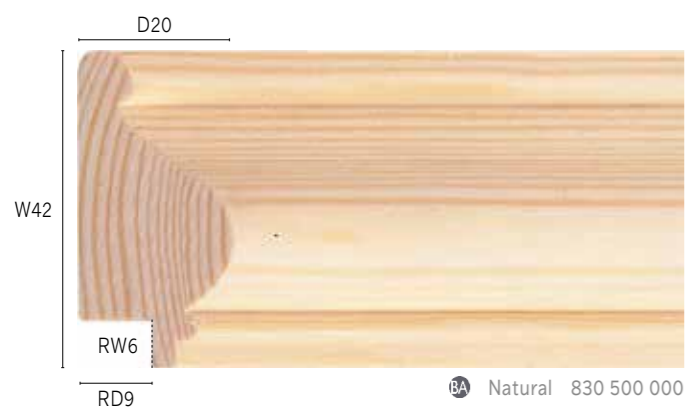
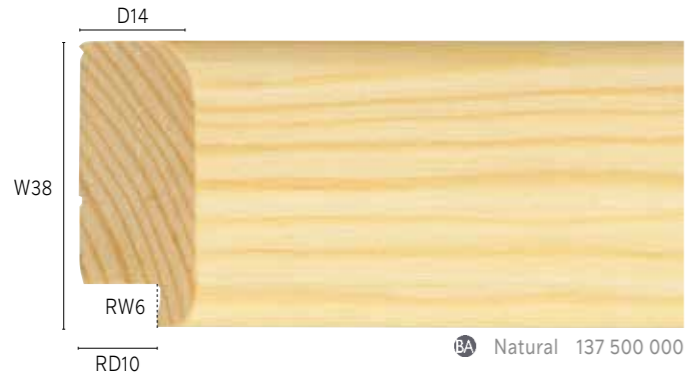
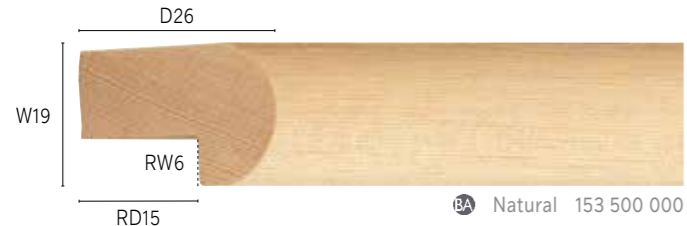

Larson-Juhl's Arrow-Head is designed for canvas artwork and involves a stretcher bar moulding made in pine, with a specially created groove, together with plastic Arrow-Head fixings. Framers simply cut appropriate lengths of moulding to size, then using an Arrow-Head in each corner create the basic structure of the frame; they then wrap the canvas around and finally secure it in place with staples. The Arrow-Heads are then tapped into the four corner joints with a hammer – an integral steel tensioner incorporated into the hard plastic Arrow-Head tightens the canvas. This stretches the canvas artwork to the desired tension.

BAREFACED! - PINE ARROW-HEAD

BAREFACED! - TULIP

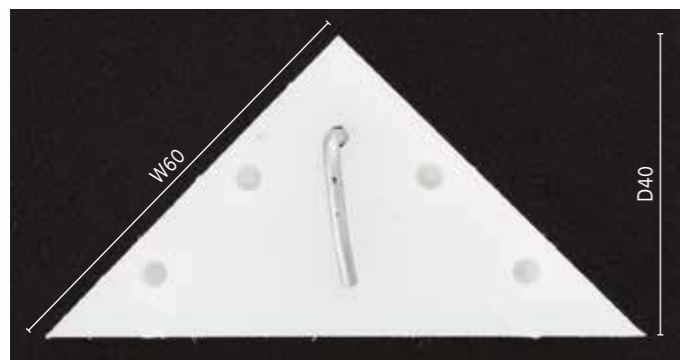

20pcs 999 000 290



Slips and Spacers

Slips and Spacers

We have a large range of slip mouldings to suit any taste, including canvas, mountslips and spacers, all which bring emphasis and a feel of high-quality to your framing project.



Moulding used
195 190 100/441 600 000

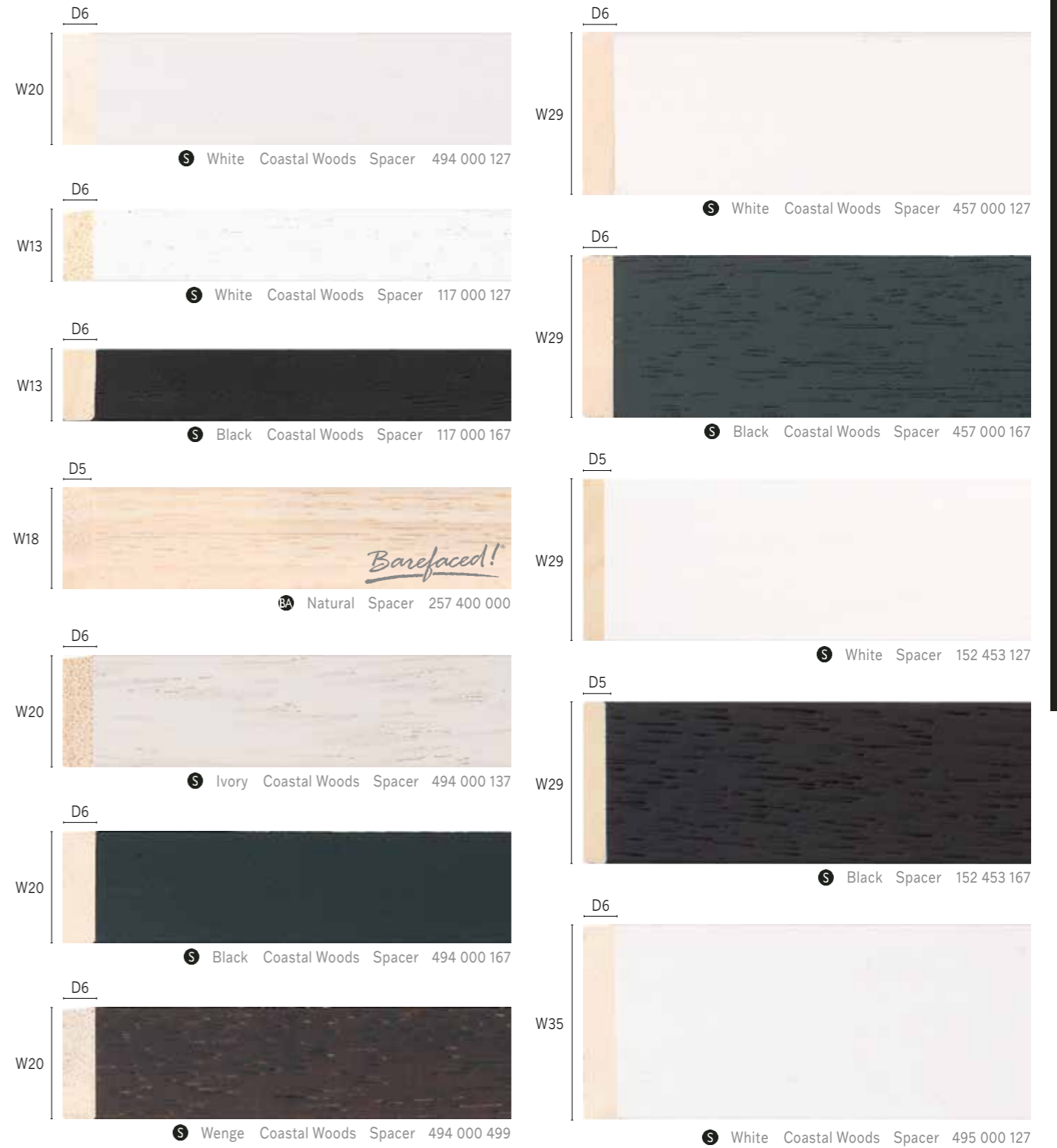
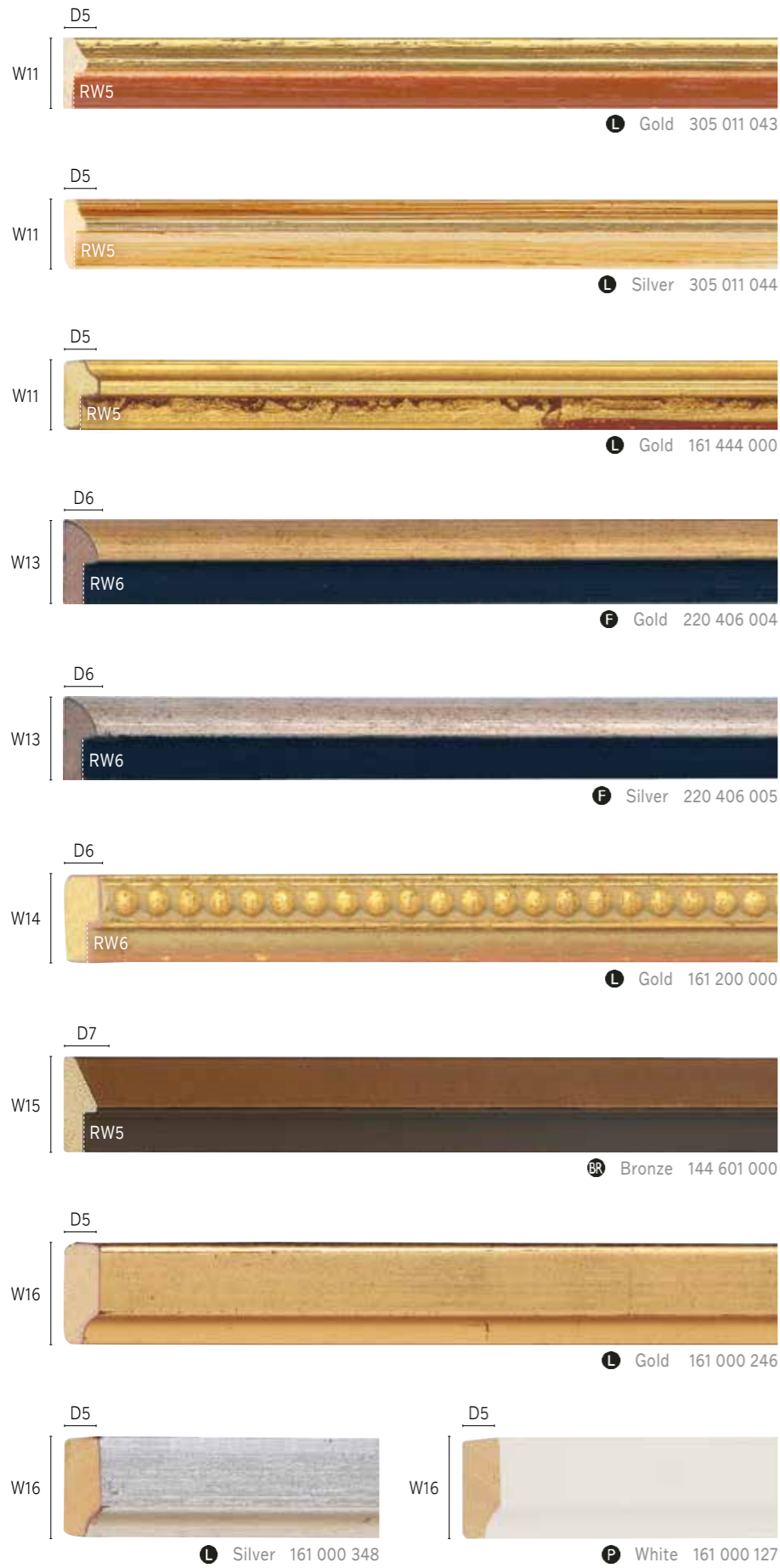

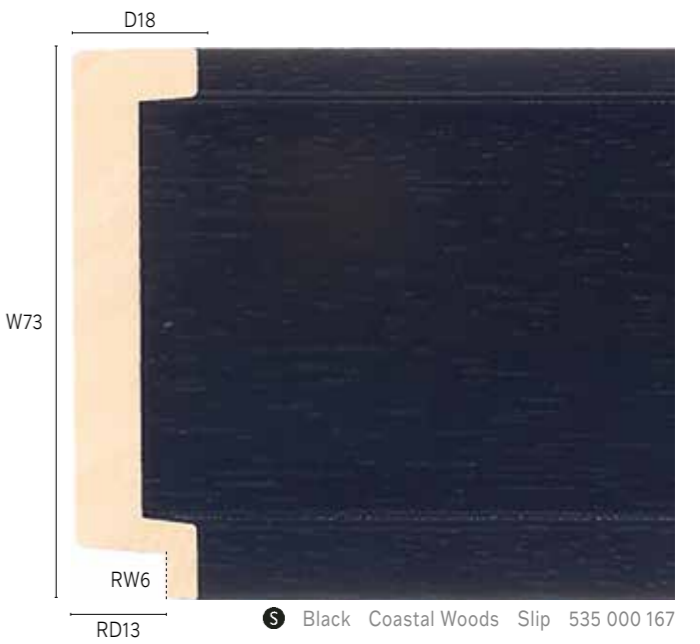
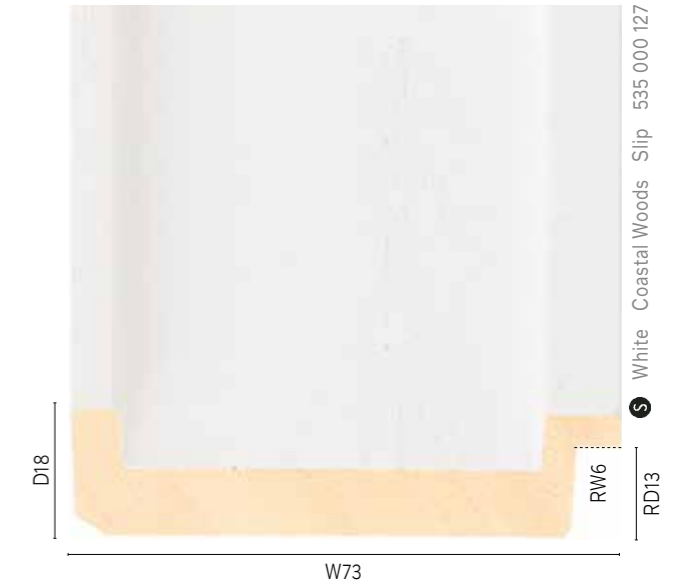
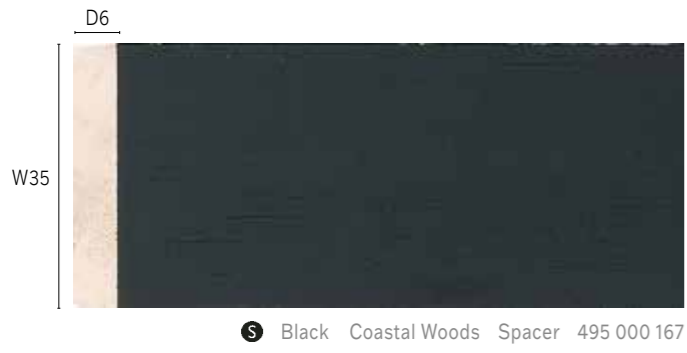

Floats and Insets

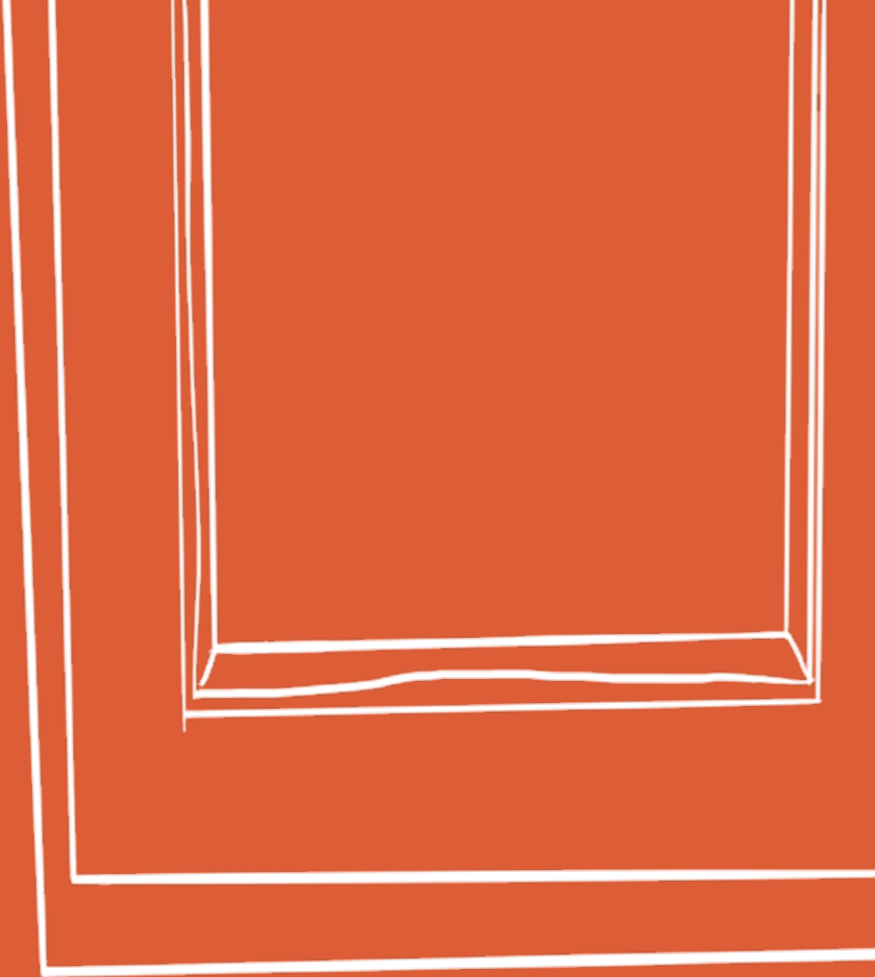

Floats

The trend towards a floating look for artwork means that this is now a hugely popular framing style. Our float range now contains over 50 styles including versatile Andover and Bari.



Moulding used

239 137 471



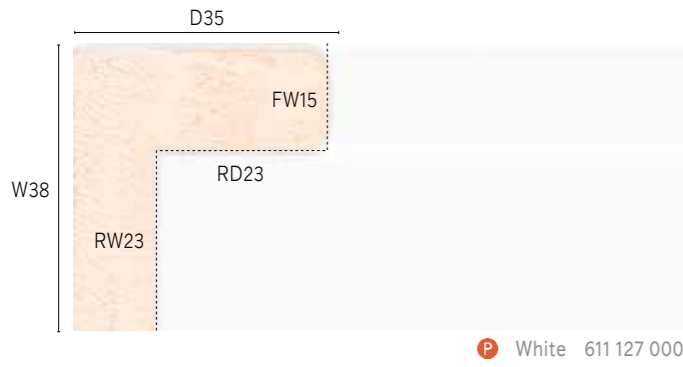

White 611 127 000



Black 611 167 000

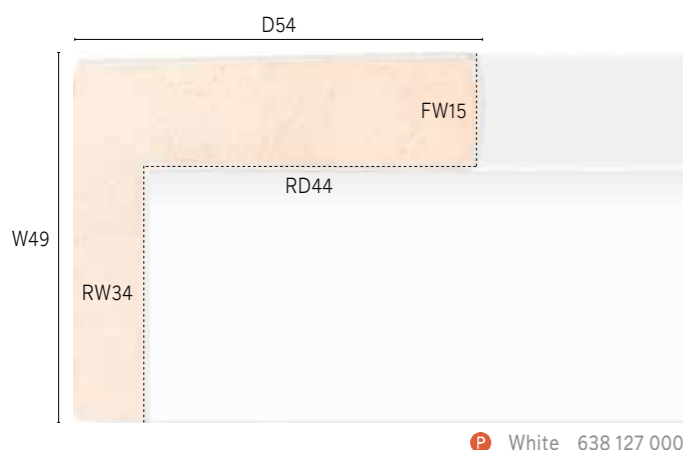

White 638 127 000



Black 638 167 000

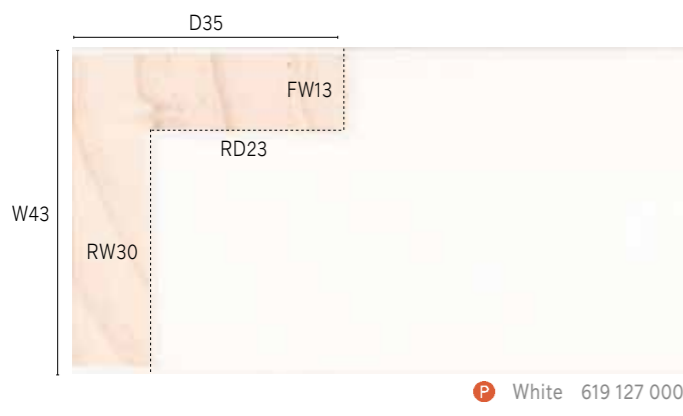

White 619 127 000



Natural 638 400 000

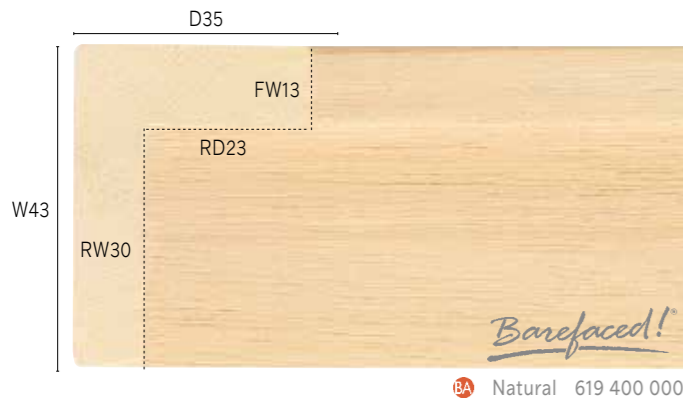

Natural 619 400 000



Black 619 167 000

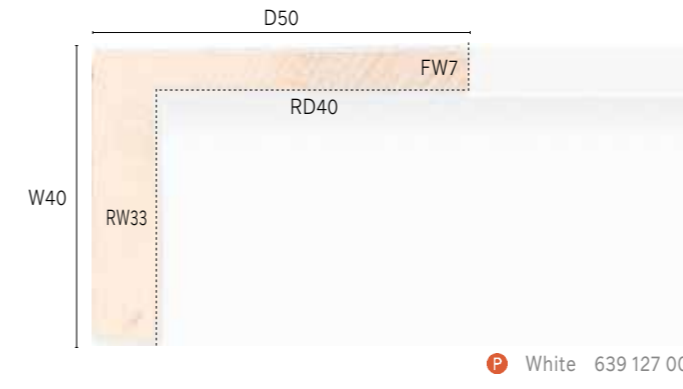

White 639 127 000

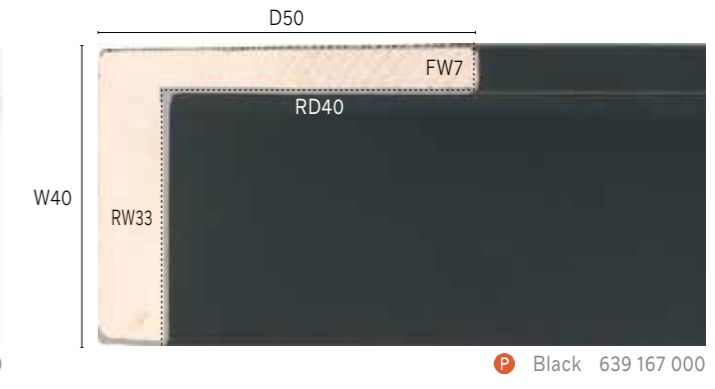

Black 639 167 000



Black Andover II Float 237 126 171

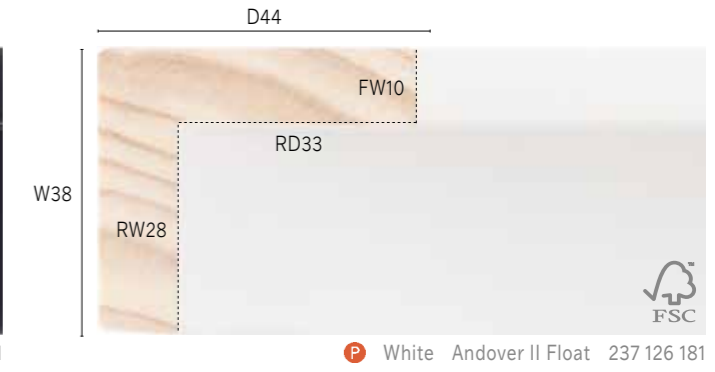

White Andover II Float 237 126 181



Gold/Brown Andover II Float 237 126 477

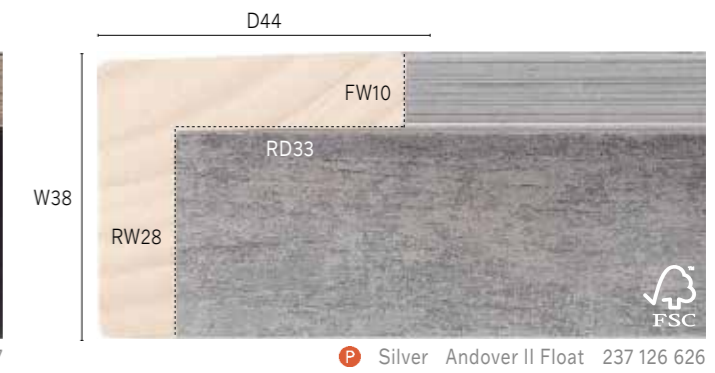

Silver Andover II Float 237 126 626



Silver/Black Andover II Float 237 126 629

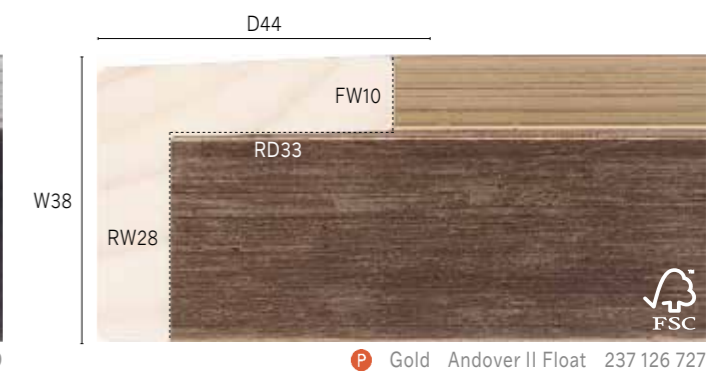

Gold Andover II Float 237 126 727



P Black/Orange Andover 236 124 471

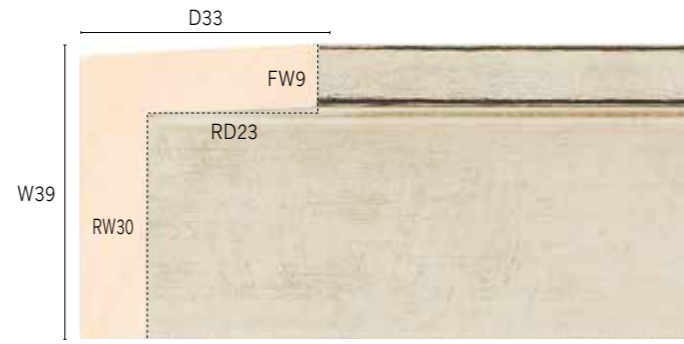

F Gold Andover 236 124 673



P Black/Orange Andover 239 137 471

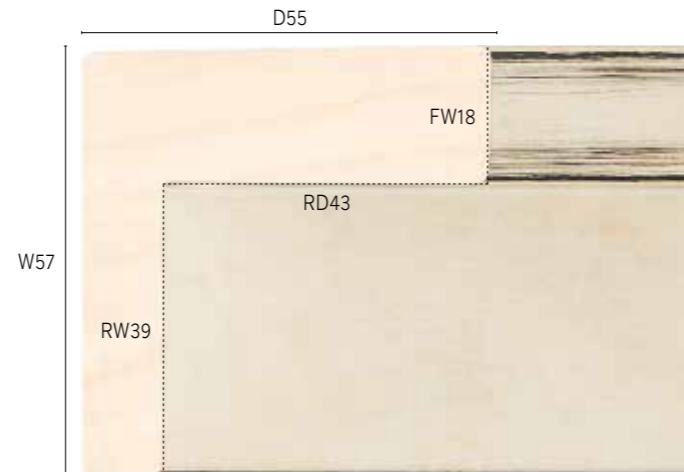

F Gold Andover 239 137 673

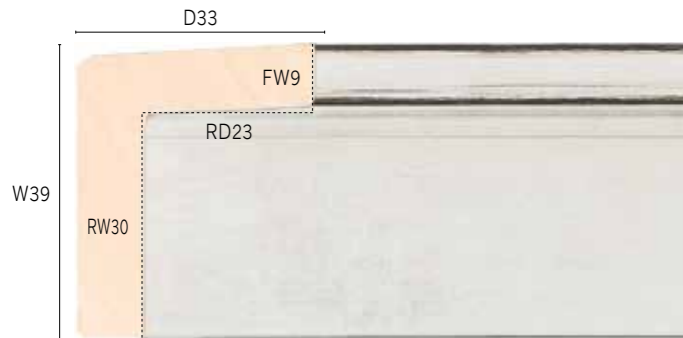

F Silver Andover 236 124 653

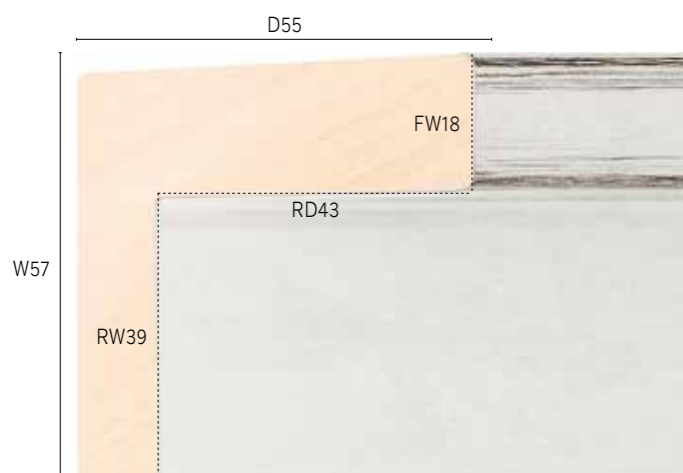

F Silver Andover 239 137 653

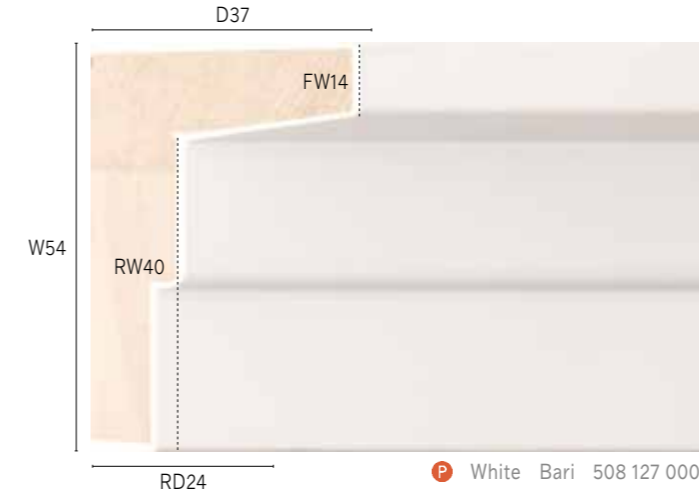

P White Bari 508 127 000



Pf Gold/Black Bari 508 167 246

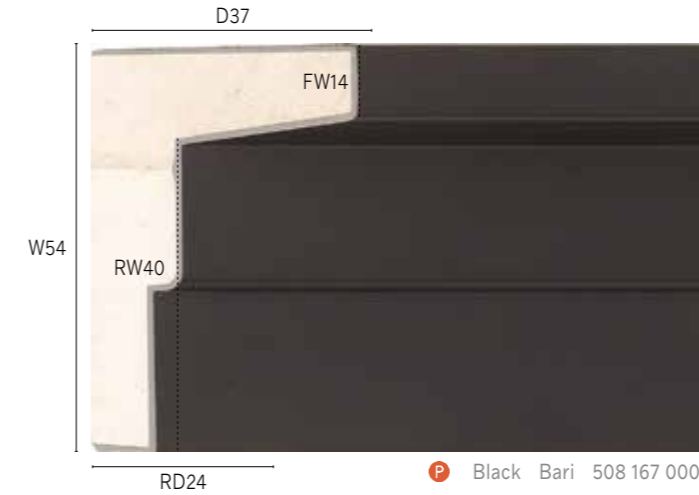

P Black Bari 508 167 000



Pf Silver/Black Bari 508 167 348

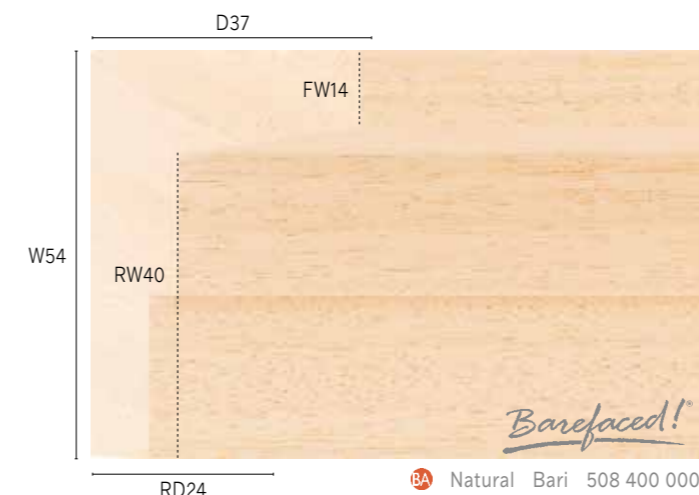

BA Natural Bari 508 400 000

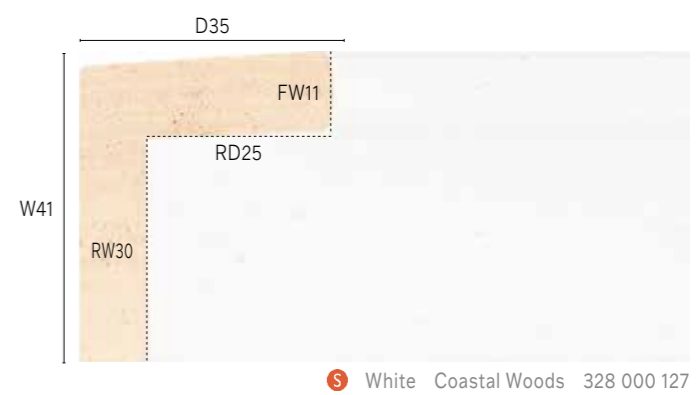

S White Coastal Woods 328 000 127

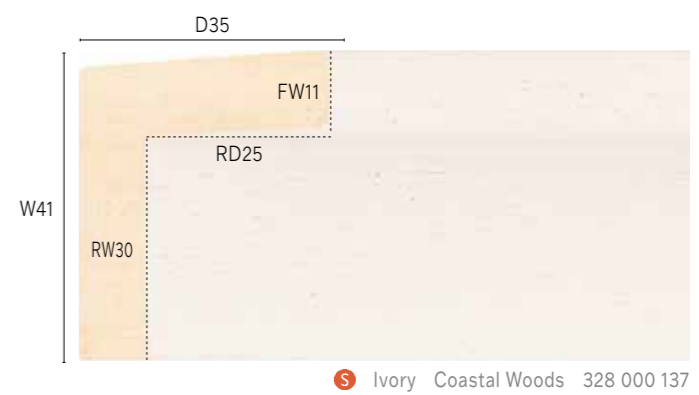

S Ivory Coastal Woods 328 000 137



S Black Coastal Woods 328 000 167



S Natural Coastal Woods 328 400 000



S Wenge Coastal Woods 328 000 499

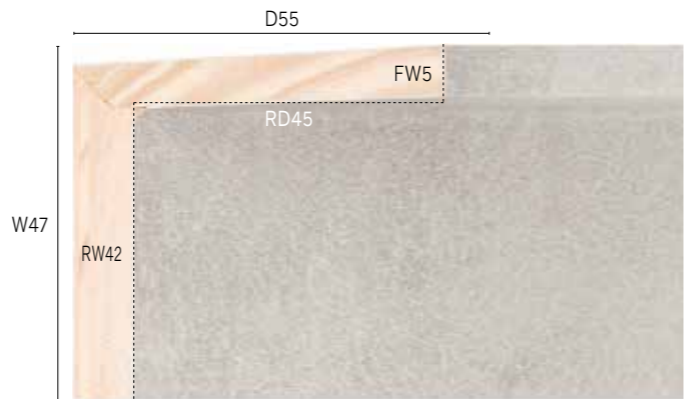

WR Light Grey TouchStone 991 243 242



S Light Grey 328 000 107

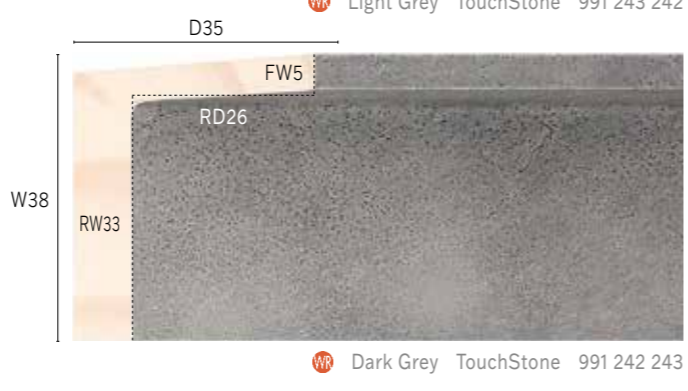

WR Dark Grey TouchStone 991 242 243



S Dark Grey 328 000 111

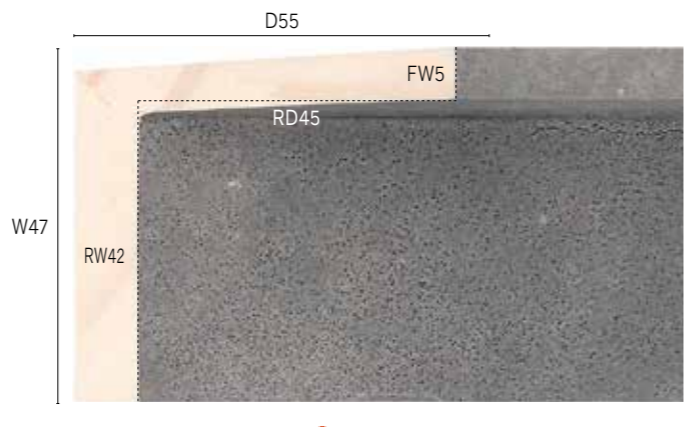

WR Dark Grey TouchStone 991 243 243



V Maple TouchWood 991 245 113



V Oak TouchWood 991 245 115



V Walnut TouchWood 991 245 116



V Wenge TouchWood 991 245 117

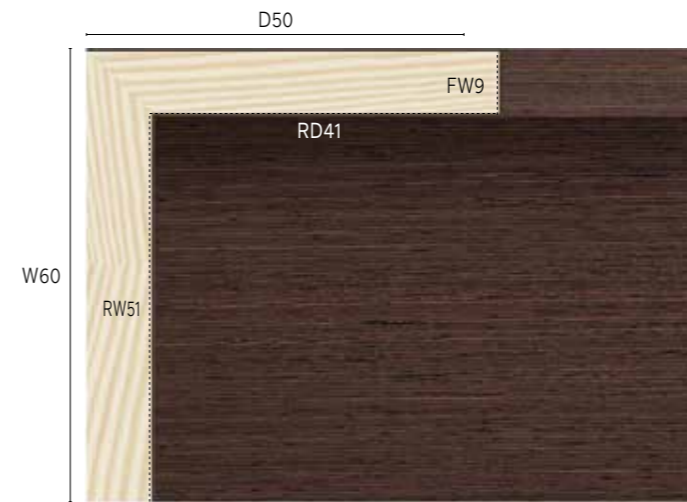

V Wenge TouchWood 991 247 117



V Oak TouchWood 991 247 115



V Oak TouchWood 991 246 115



V Walnut TouchWood 991 246 116

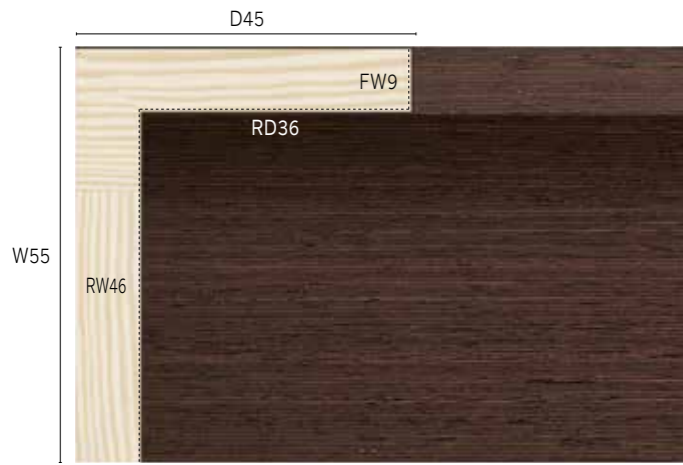

V Wenge TouchWood 991 246 117



S Black Coastal Woods 511 000 167

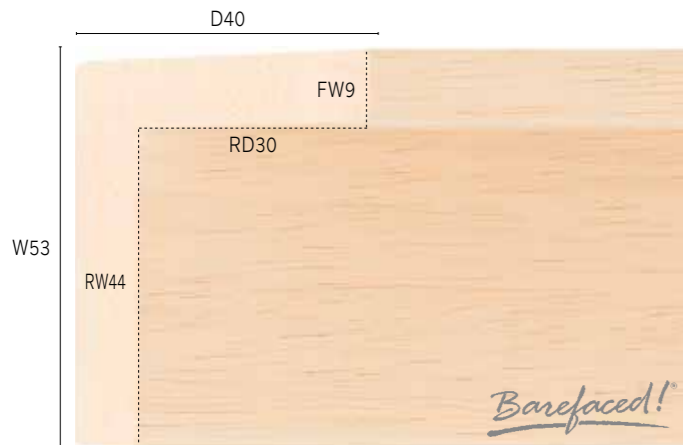

BA Natural 511 400 000

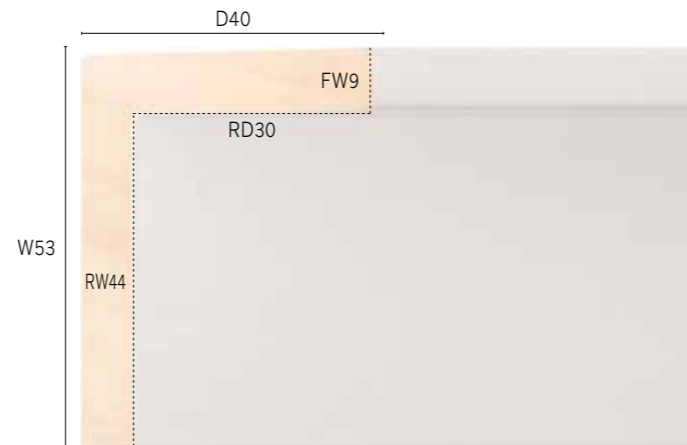

S White Coastal Woods 511 000 127

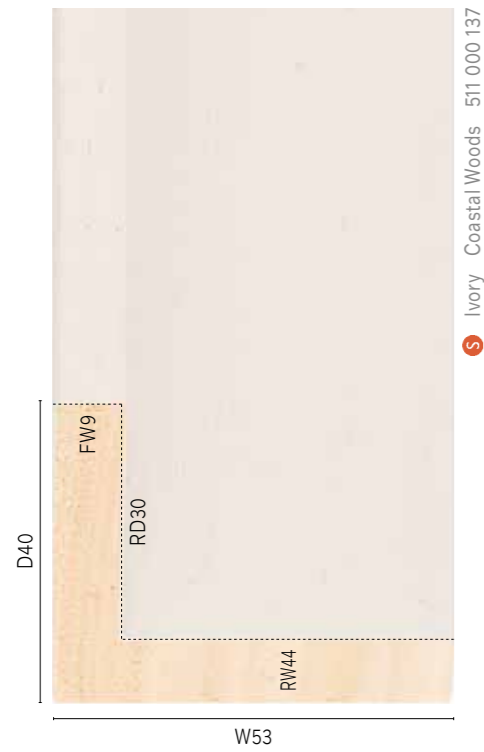

S Ivory Coastal Woods 511 000 137

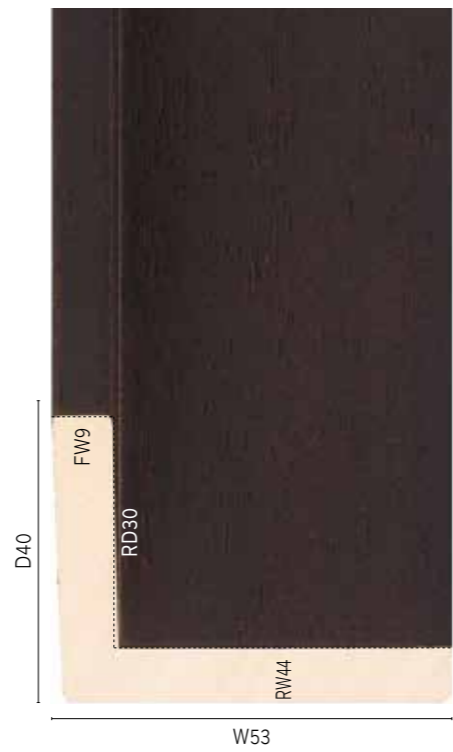

S Wenge Coastal Woods 511 000 499

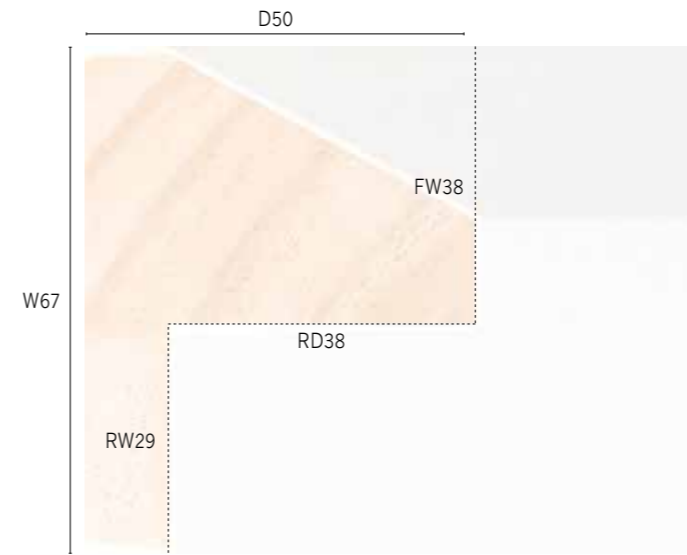

P White 515 127 000

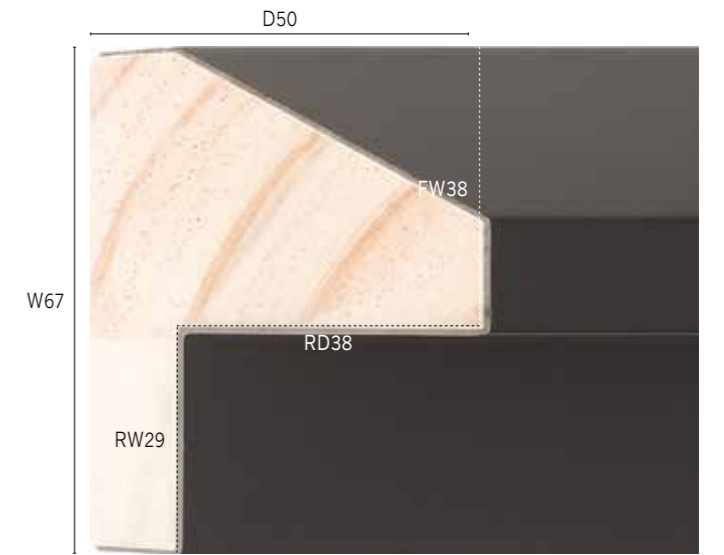

P Black 515 167 000

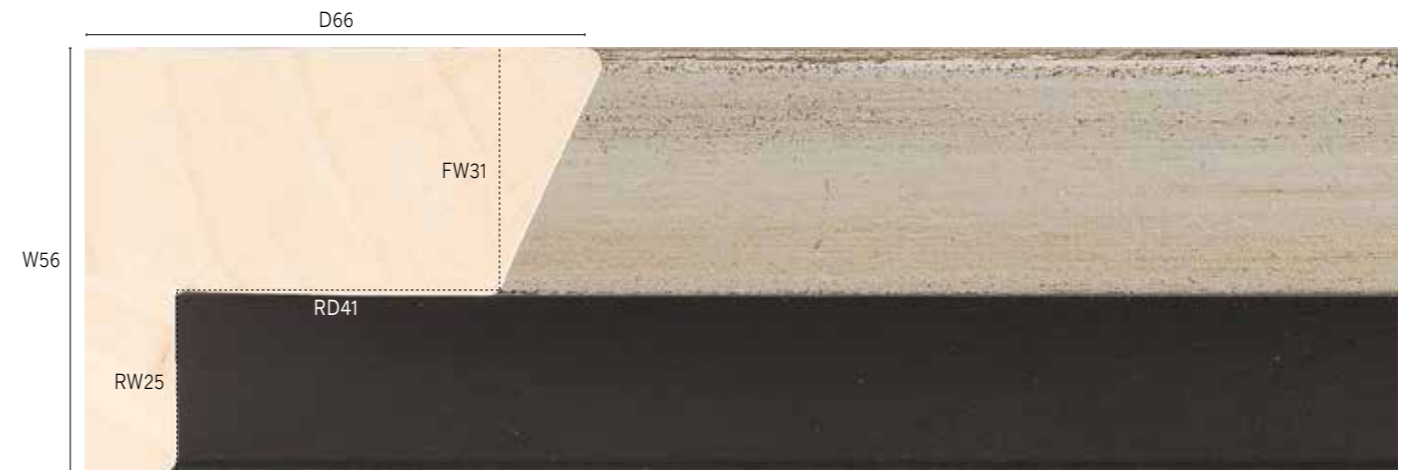

PL Black/Silver Winchester 942 006 054



PL Black/Silver Verdi 913 054



P Ivory Verdi 913 048

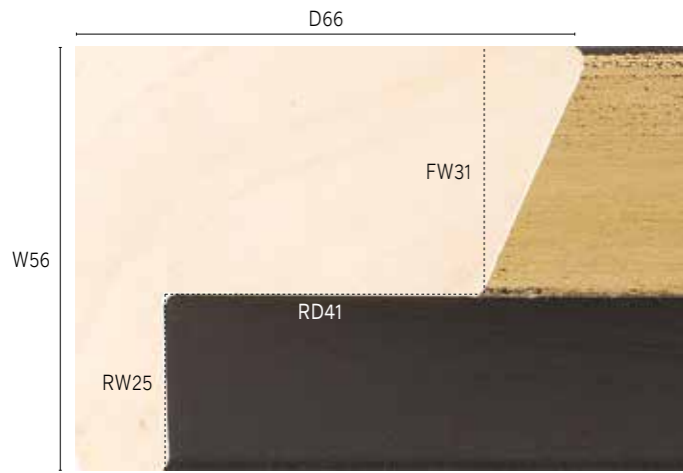

P Black/Gold Winchester 942 006 055

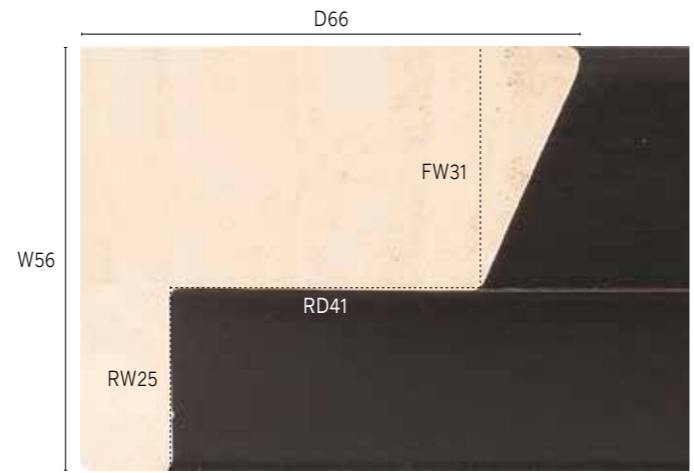

P Black Winchester 942 006 086

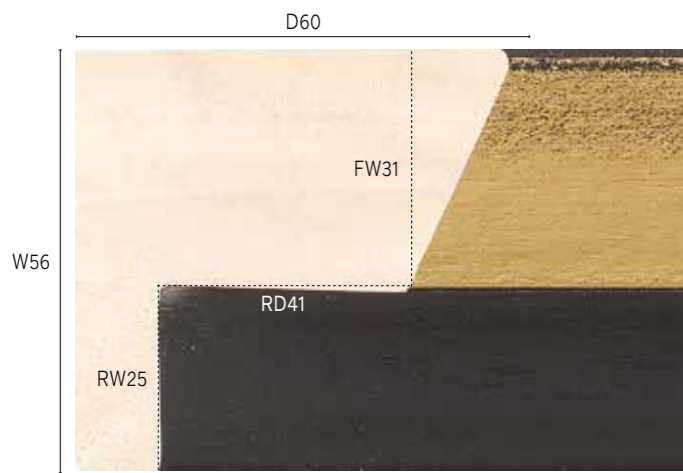

P Black/Gold Verdi 913 055

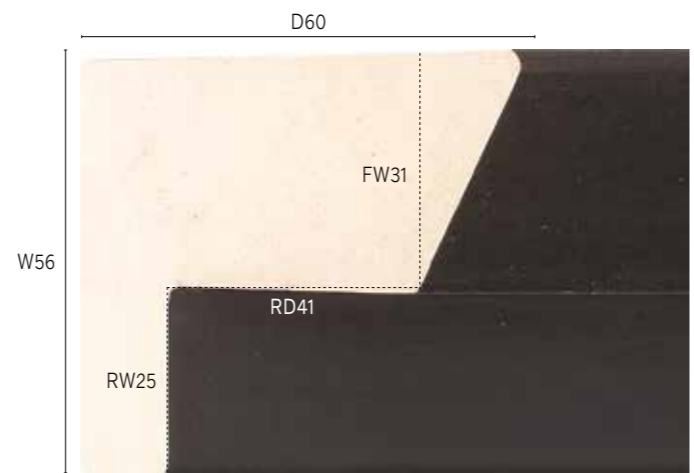

P Black Verdi 913 086

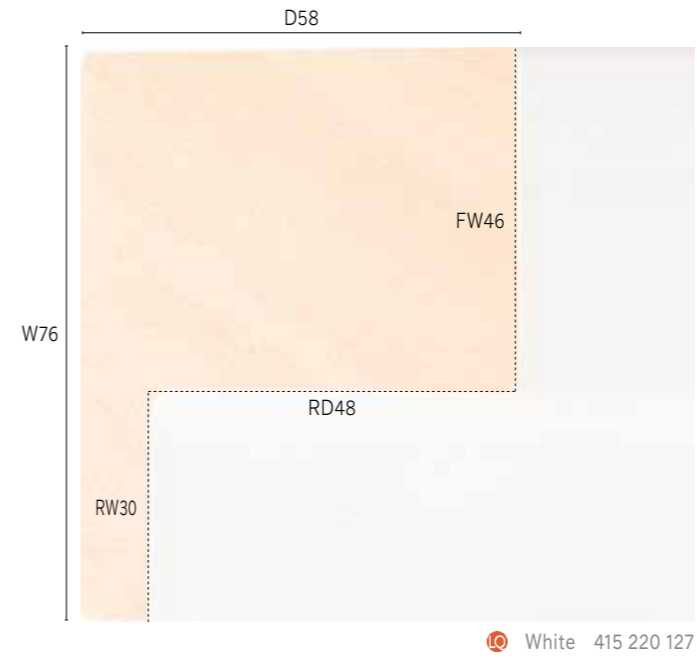

P White 415 220 127

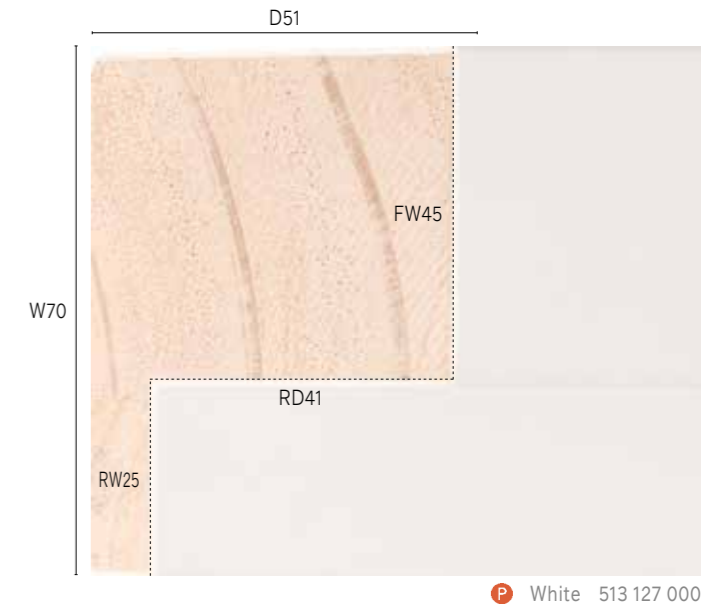

P White 513 127 000

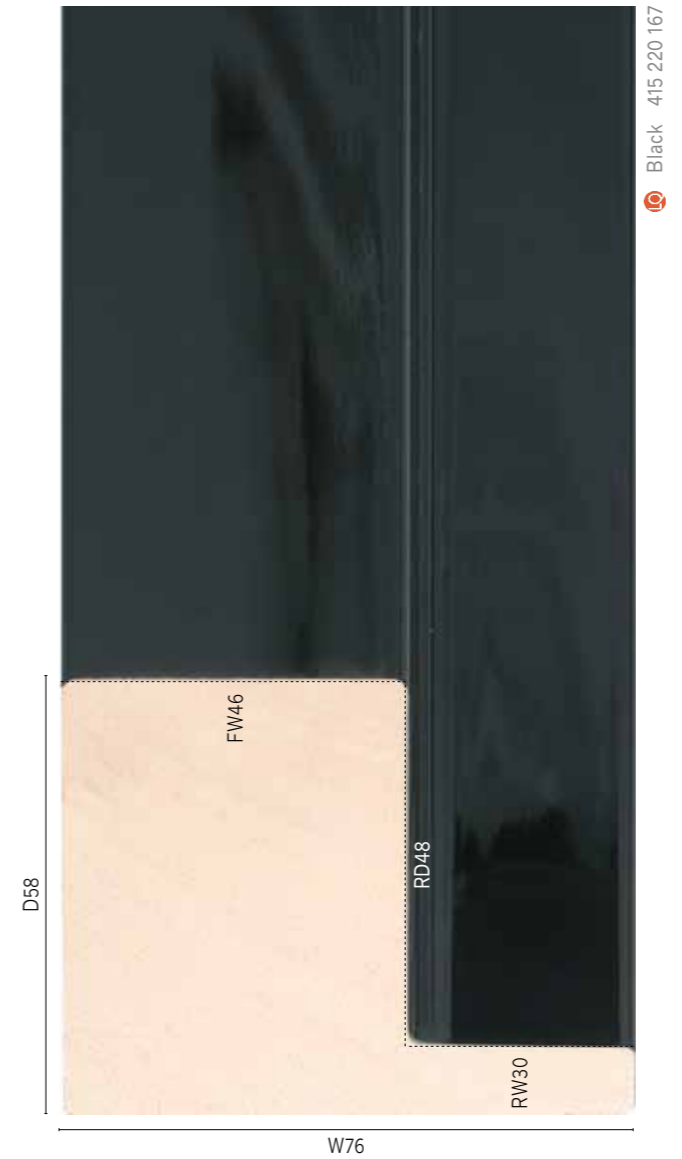

P Black 415 220 167



P Black 513 287 000



P Black 513 167 000



S White Coastal Woods 407 000 127

S Black Coastal Woods 407 000 167



Insets

Our inset mouldings can be used in two ways; either as a regular moulding or on their side to create a box-style frame. This range also includes our Barefaced! style for when you want the understated class of a natural wood finish.



Moulding used

282 167 000

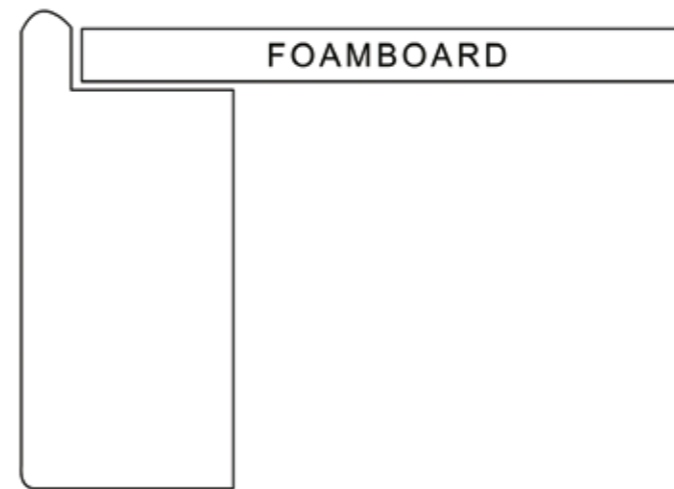
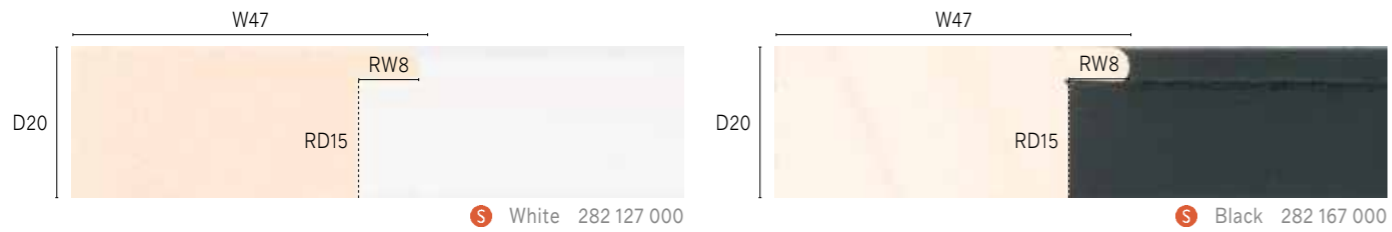
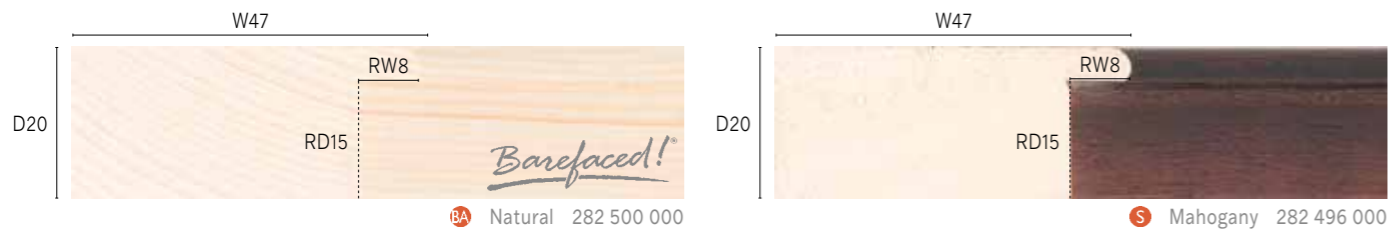
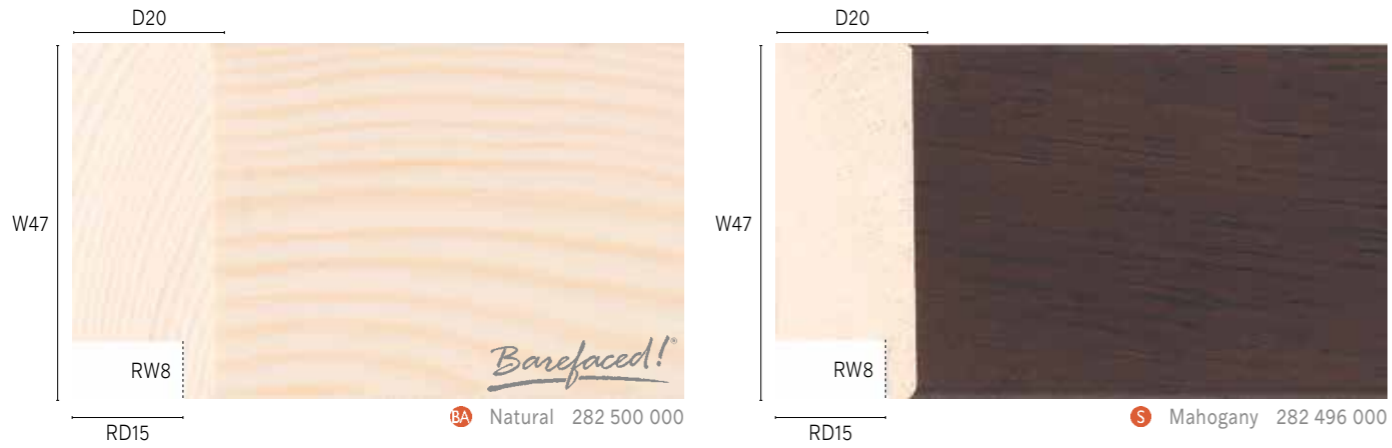

Designer Aluminium framing system and mitre service

Aluminium framing system

The LJ Aluminium range is distributed in the UK exclusively by Larson-Juhl.

There are 14 different profiles available in a wide choice of colours and finishes. Overleaf we illustrate all 31 colours, the Artel finishes are actually bonded to the metal for unparalleled scratch resistance and corner cuts that won't chip or flake.

Aluminium framing mitre service

We operate, nationwide, the Designer Mouldings Mitre Service, which can supply framing kits of precut mitred aluminium mouldings. Each frame kit is supplied complete with corner brackets, spring clips, hangers and wall protection bumpers.



Moulding used
860 260 000

Powder Coated

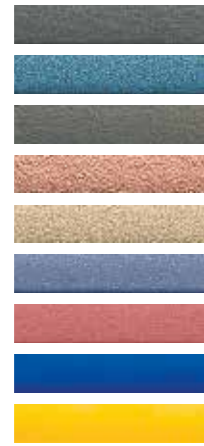

- 300 Etched Black
- 303 Pacific Mist
- 305 Khaki
- 309 Etched Bronze
- 310 Gothic Gold
- 313 Cobalt Blue
- 316 Paprika
- 401 Jollipop Blue
- 404 Jollipop Yellow

Anodised



- 11 Silver
- 12 Frosted Silver
- 13 Gold
- 14 Frosted Gold
- 15 Copper
- 16 Frosted Copper
- 17 Grey Pewter
- 20 Gun Metal
- 22 Dark Bronze
- 23 Old World Pewter
- 25 Satin Black
- 26 Bright Black
- 28 Light Gold

Artel Coating

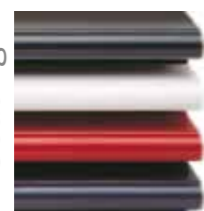

- 30 Raven Black
- 31 Snowflake White
- 33 Chinese Red
- 37 Newport Blue

Artel High Gloss Finish



- 100 Jet Black
- 101 Cardinal Red
- 103 Midnight Blue
- 115 Evergreen
- 123 Photo Grey

Profile 29

12 Frosted Silver 290 120 000

14 Frosted Gold 290 140 000

17 Grey Pewter 290 170 000

25 Satin Black 290 250 000

23 Old World Pewter 290 230 000

Profile 37

11 Silver 370 110 000

13 Gold 370 130 000

25 Satin Black 370 250 000

Profile 38

11 Silver 380 110 000

13 Gold 380 130 000

14 Frosted Gold 380 140 000

404 Jollipop Yellow 380 404 000

Profile 38

300 Etched Black 380 300 000

303 Pacific Mist 380 303 000

305 Khaki 380 305 000

309 Etched Bronze 380 309 000

310 Gothic Gold 380 310 000

313 Cobalt Blue 380 313 000

316 Paprika 380 316 000

401 Jollipop Blue 380 401 000

20 Gun Metal 380 200 000

Profile 38

25 Satin Black 380 250 000

11 Silver 410 110 000

25 Satin Black 410 250 000

Profile 41

11 Silver 410 110 000

25 Satin Black 410 250 000

Profile 43

11 Silver 430 110 000

Profile 50

11 Silver 500 110 000

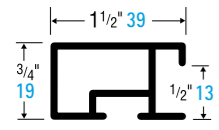

Profile 59



06 Stainless 590 006 000



12 Frosted Silver 590 012 000



17 Grey Pewter 590 170 000



25 Satin Black 590 250 000

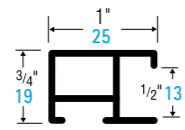

Profile 60



06 Stainless 600 006 000



12 Frosted Silver 600 012 000



17 Grey Pewter 600 170 000



25 Satin Black 600 250 000

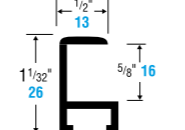

Profile 67



11 Silver 670 110 000

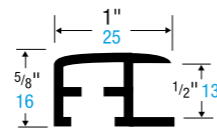

Profile 68



11 Silver 680 110 000

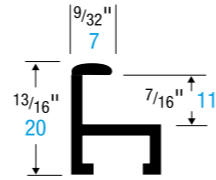

Profile 84



11 Silver 840 110 000



12 Frosted Silver 840 120 000



13 Gold 840 130 000



14 Frosted Gold 840 140 000



16 Frosted Copper 840 160 000



17 Grey Pewter 840 170 000



20 Gun Metal 840 200 000



22 Dark Bronze 840 220 000

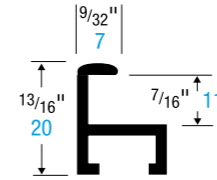

Profile 84



23 Old World Pewter 840 230 000



25 Satin Black 840 250 000



26 Bright Black 840 260 000



30 Raven Black 840 300 000



31 Snowflake White 840 310 000

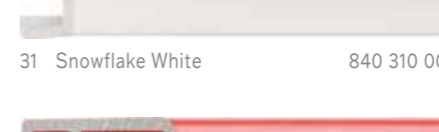

33 Chinese Red 840 330 000

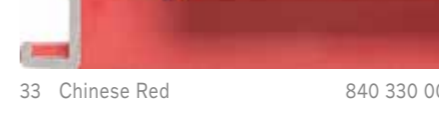

37 Newport Blue 840 370 000

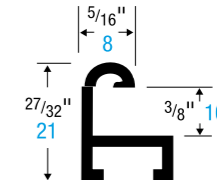

Profile 85



11 Silver 850 011 000



12 Frosted Silver 850 012 000



100 Jet Black 850 100 000

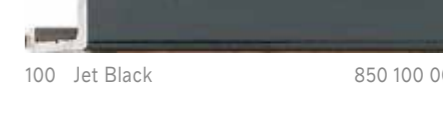

103 Midnight Blue 850 103 000



105 Slate Blue 850 105 000



105 Slate Blue 850 105 000



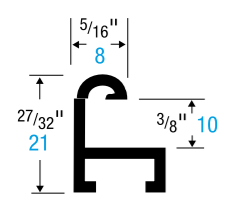

Profile 85

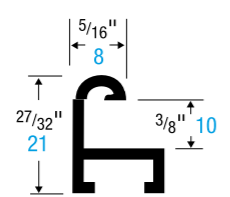

Profile 85

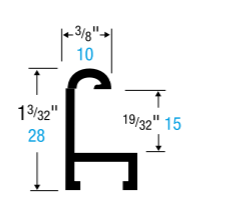

Profile 86

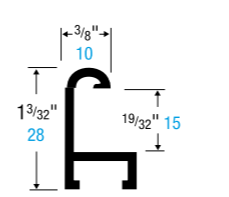

Profile 86

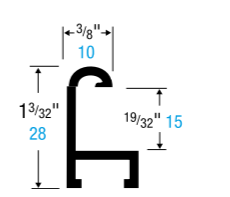

Profile 86

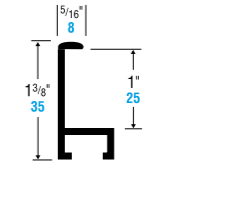

Profile 99



123 Photo Grey 850 123 000



22 Dark Bronze 850 220 000



11 Silver 860 011 000



17 Grey Pewter 860 170 000



30 Raven Black 860 300 000



11 Silver 990 110 000



13 Gold 850 130 000



23 Old World Pewter 850 230 000



12 Frosted Silver 860 012 000



20 Gun Metal 860 200 000



31 Snowflake White 860 310 000



12 Frosted Silver 990 120 000



14 Frosted Gold 850 140 000



25 Satin Black 850 250 000



100 Jet Black 860 100 000



22 Dark Bronze 860 220 000

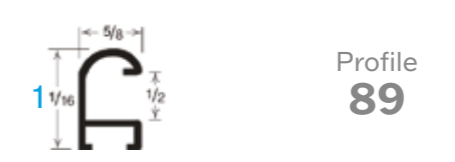

Profile 89



15 Copper 850 150 000



26 Bright Black 850 260 000



101 Cardinal Red 860 101 000

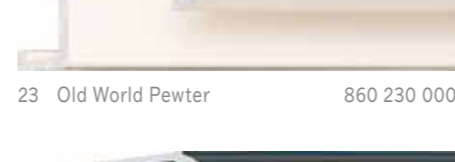

23 Old World Pewter 860 230 000



11 Silver 890 011 000



16 Frosted Copper 850 160 000



30 Raven Black 850 300 000

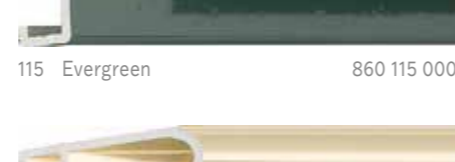

115 Evergreen 860 115 000



25 Satin Black 860 250 000



13 Gold 890 130 000



17 Grey Pewter 850 170 000



37 Newport Blue 850 370 000



13 Gold 860 130 000



26 Bright Black 860 260 000



20 Gun Metal 850 200 000



14 Frosted Gold 860 140 000

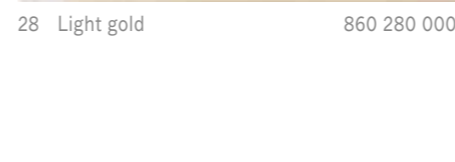

28 Light gold 860 280 000

16 Frosted Copper 860 160 000



25 Satin Black 990 250 000



13 Gold 990 130 000



Artcore

Sleek, stylish and affordable, Artcore by Larson-Juhl offers an unparalleled selection of mouldings to complement any framing project. This collection of versatile styrene mouldings is available in many different styles, including metallic foil finishes, stark matt monochrome, wood effect or embossed. All Artcore mouldings are sold in box quantity only.

Moulding used
721 0AC 891



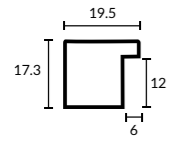

Profile 720

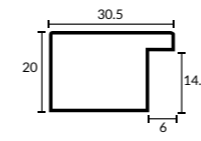

Profile 721

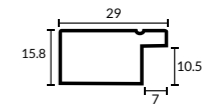

Profile 771

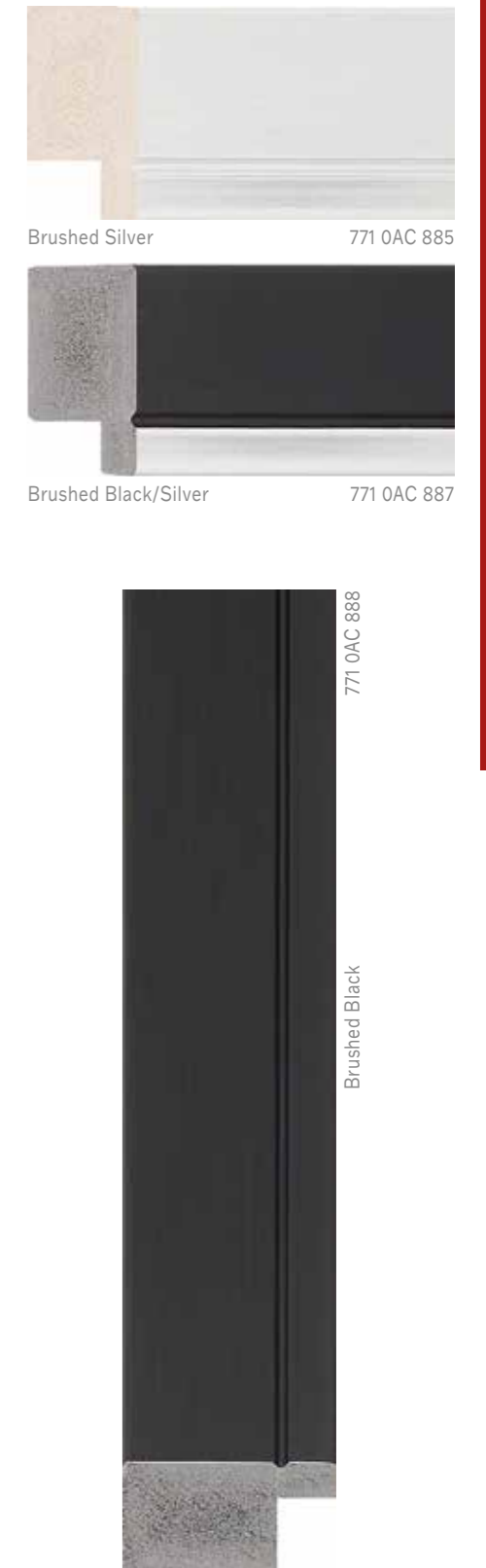

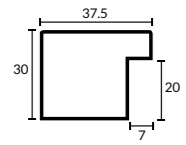

Profile 722

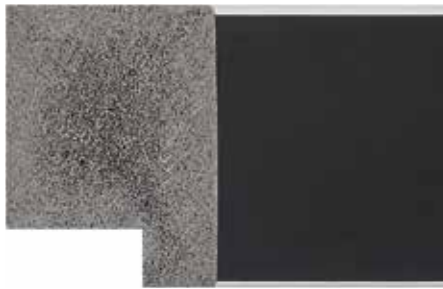

Black/Silver 722 OAC 714



Matt White 722 OAC 801

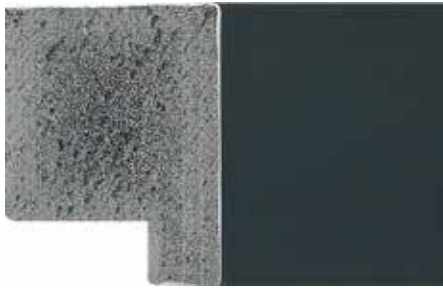

Brushed Black 722 OAC 805

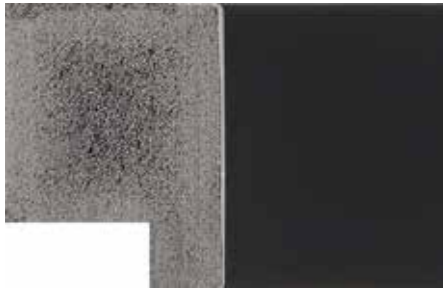

Matt Black 722 OAC 806

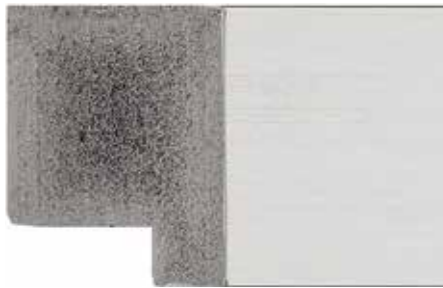

Brushed Silver 722 OAC 808



Black Ash 722 OAC 811



Mahogany 722 OAC 892



722 OAC 713

Black/Gold

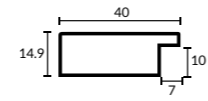

Profile 220



Brushed Black 220 OAC 805



Matt Black 220 OAC 806



Brushed Silver 220 OAC 808



Brushed Pewter 220 OAC 809

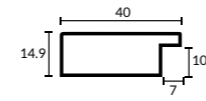

Profile 220

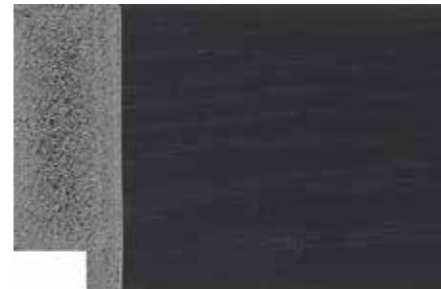

Black Ash 220 OAC 811



Oak 220 OAC 891

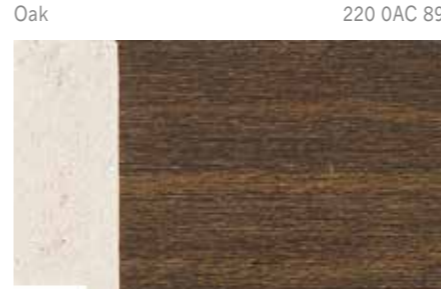

Mahogany 220 OAC 892

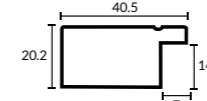

Profile 772



Brushed Silver 772 OAC 885



Brushed Black/Silver 772 OAC 887



Brushed Black 772 OAC 888

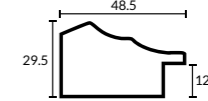

Profile 774



774 OAC 897

Silver





Profile 219

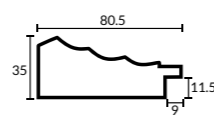

Profile 775



Gold

219 OAC 579



White Lacquered

775 OAC 895



219 OAC 580

Silver



Black Lacquered

775 OAC 896

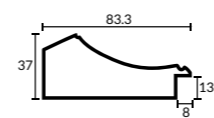

Profile 749



Silver

749 OAC 875



Pewter

749 OAC 876



Ready Made Frames

Decorative	411
Plain	413
Overmantle	414
Swept	420
Oval and Circle	429
Proportional Profiles	430

Larson-Juhl's range of decorative frames provides the perfect finishing touch for mirrors, portraits and photographs.

Our carved and ornate styles are sophisticated and chic, this stylish range has proved to be extremely popular with framers.

Decorative Frames

READY MADE FRAMES

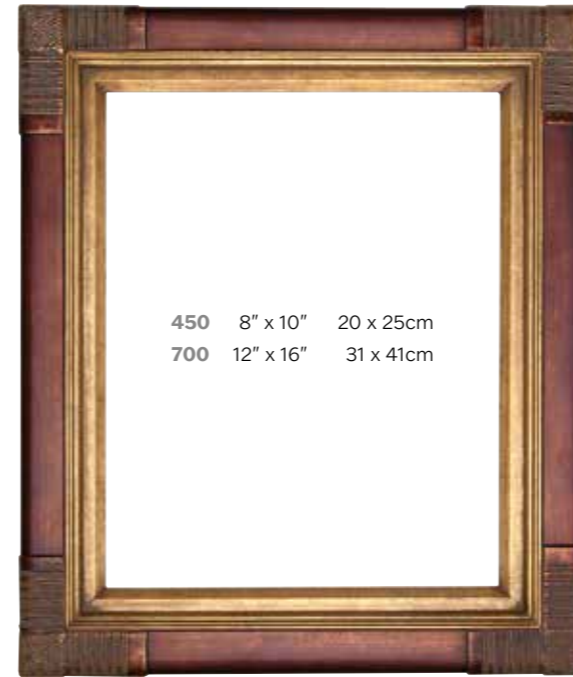

450 8" x 10" 20 x 25cm
700 12" x 16" 31 x 41cm

3.5" 89mm Gold

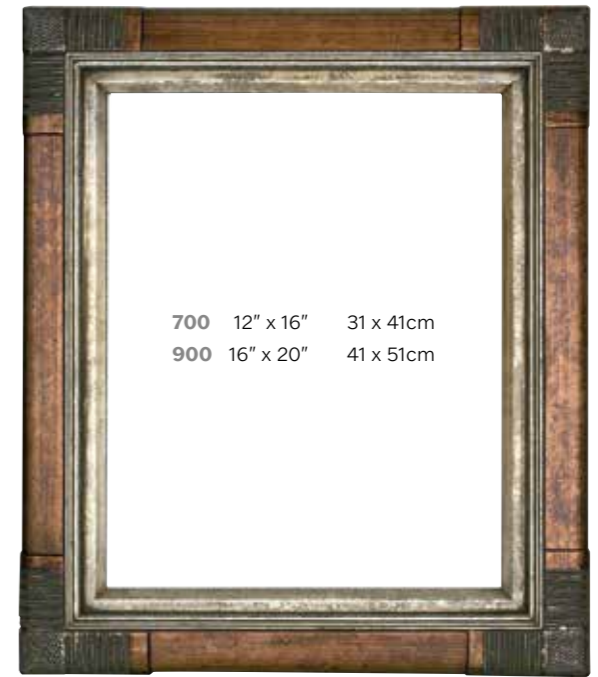

700 12" x 16" 31 x 41cm
900 16" x 20" 41 x 51cm

897 693 ___ 3.5" 89mm Silver

897 348 ___

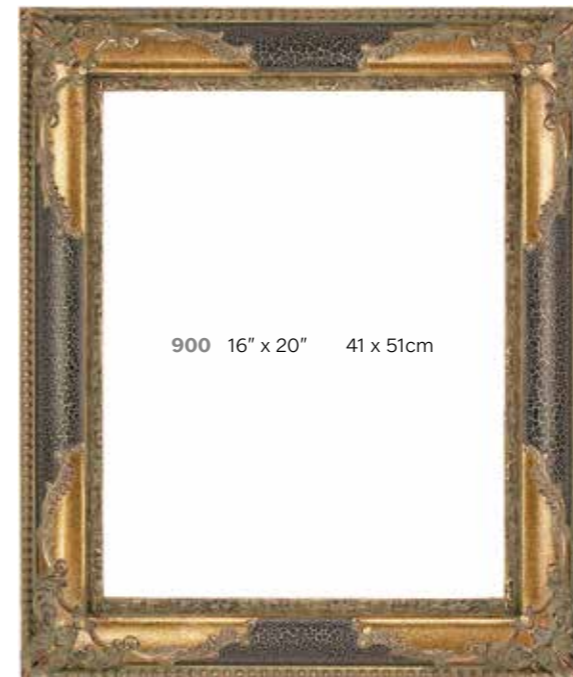

900 16" x 20" 41 x 51cm

3" 76mm Black and Gold

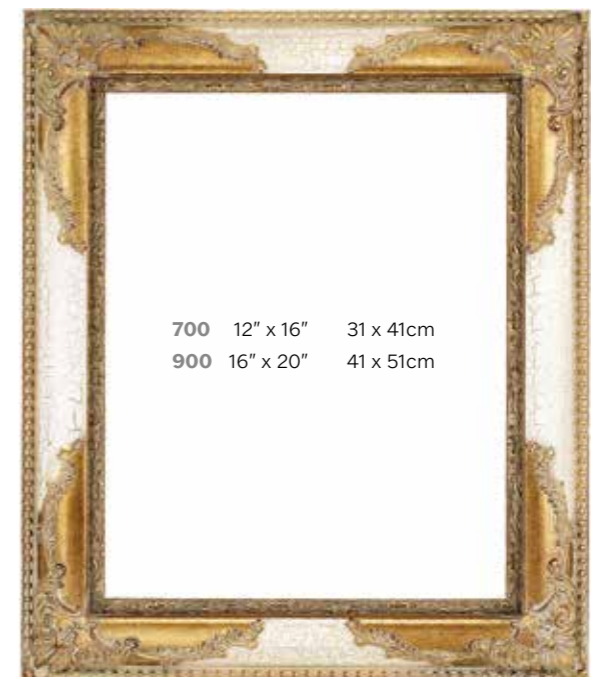

700 12" x 16" 31 x 41cm
900 16" x 20" 41 x 51cm

860 167 ___ 3" 76mm Ivory and Gold

860 157 ___

Plain Frames

Contemporary, plain frames are ideal for a wide range of basic framing requirements, such as mirrors, photographs, prints and posters. Offering excellent value for money, our minimalist picture frames have become a popular choice with customers.

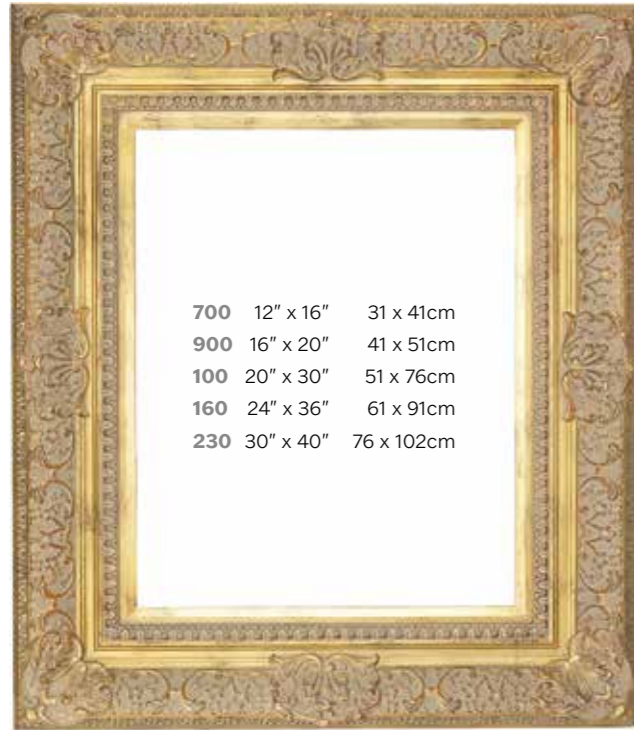

700 12" x 16" 31 x 41cm
 900 16" x 20" 41 x 51cm
 100 20" x 30" 51 x 76cm
 160 24" x 36" 61 x 91cm
 230 30" x 40" 76 x 102cm

5" 127mm Gold

139 693 _ _ _



450 8" x 10" 20 x 25cm
 700 12" x 16" 31 x 41cm
 900 16" x 20" 41 x 51cm
 100 20" x 30" 51 x 76cm
 160 24" x 36" 61 x 91cm
 230 30" x 40" 76 x 102cm

5" 127mm Silver

139 348 _ _ _

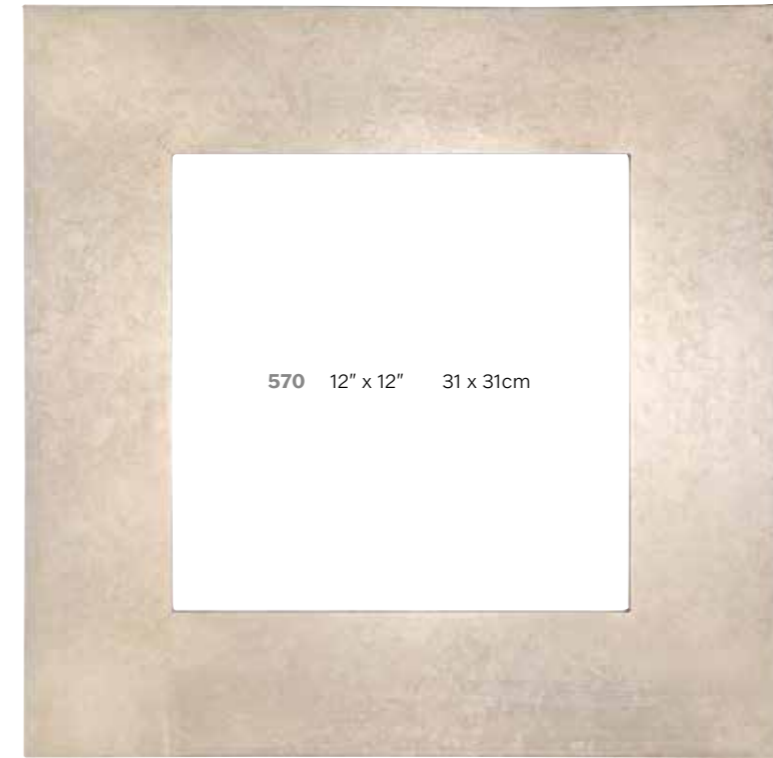

570 12" x 12" 31 x 31cm

6.25" 160mm Silver

811 348 _ _ _

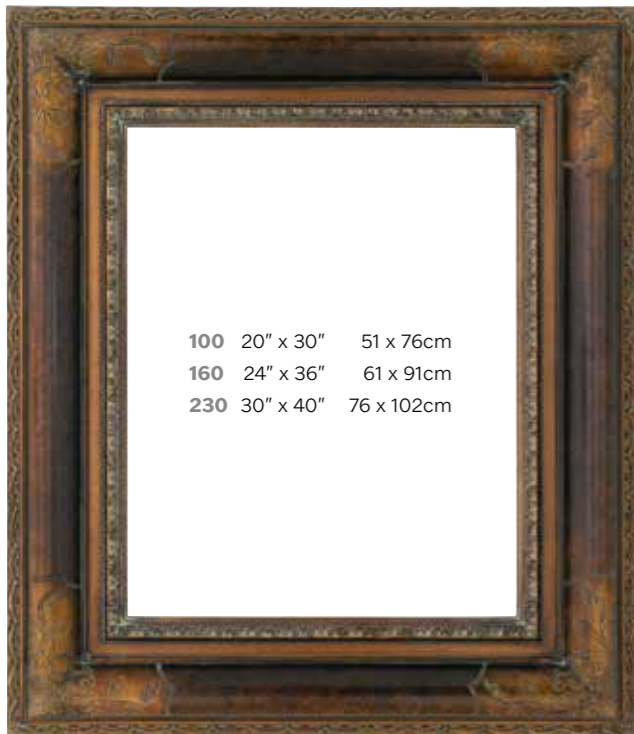

100 20" x 30" 51 x 76cm
 160 24" x 36" 61 x 91cm
 230 30" x 40" 76 x 102cm

5.5" 140mm Bronze

805 567 _ _ _

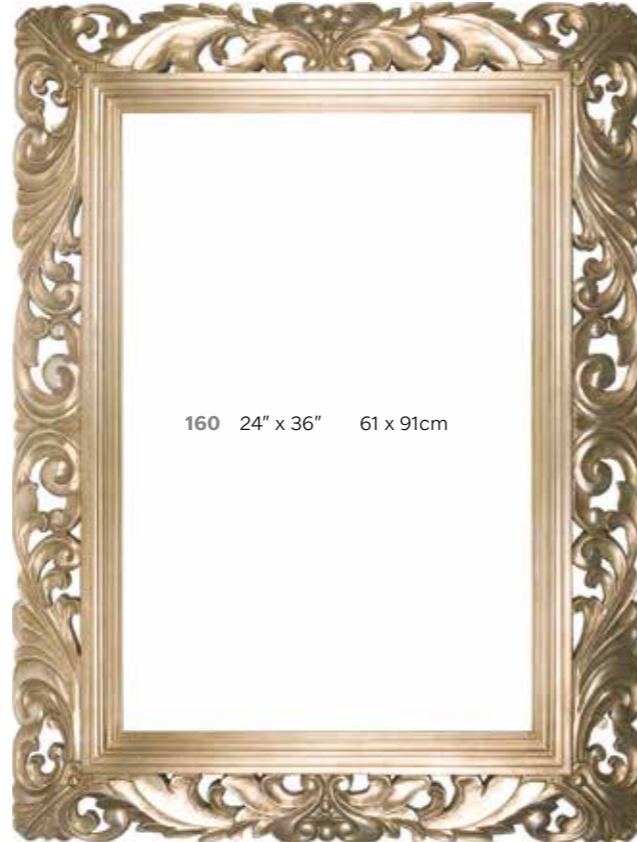

160 24" x 36" 61 x 91cm

6.5" 165mm Silver

862 348 _ _ _



770 20" x 20" 51 x 51cm

6.25" 160mm Bronze

811 567 _ _ _

Overmantle Frames

Eye-catching and unusual, the clean lines of Larson-Juhl's mantel picture frames provide the perfect finish to classical or contemporary fireplace mirrors. Available in gold, silver, ivory, black and white the Overmantle will add that finishing touch to any room.

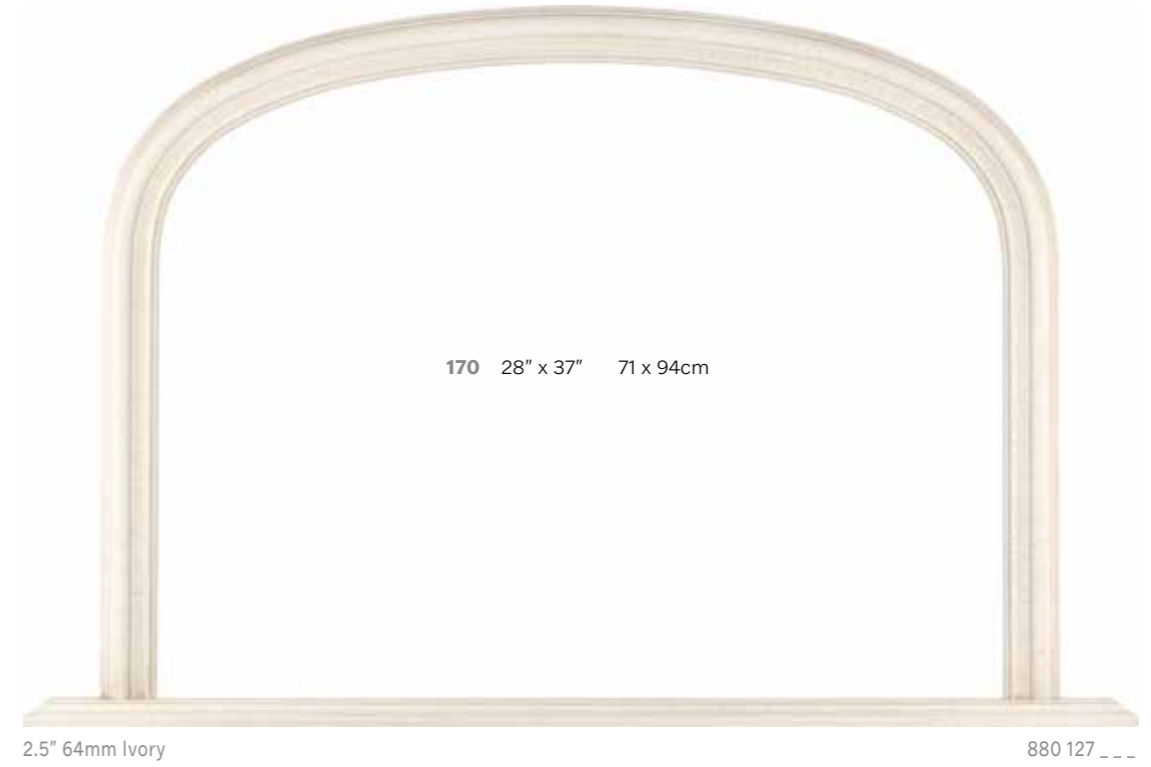

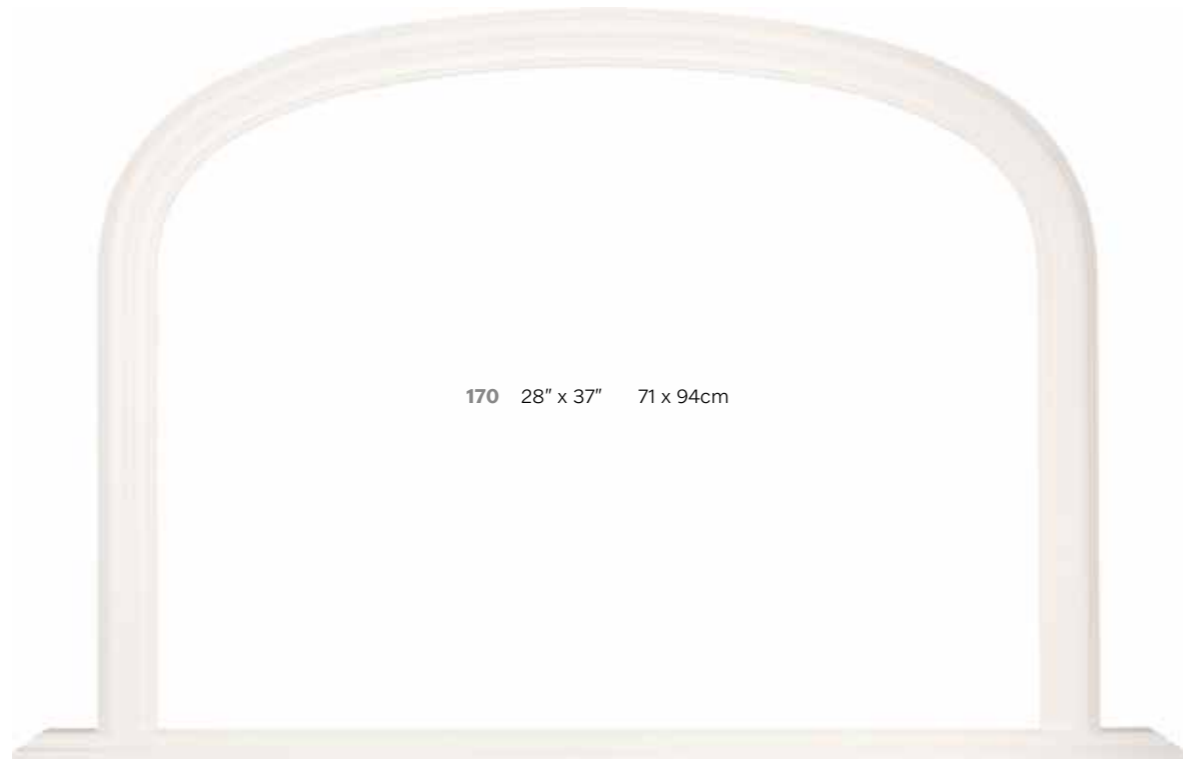

170 28" x 37" 71 x 94cm

2.5" 64mm White

880 117 _ _ _



170 28" x 37" 71 x 94cm

2.5" 64mm Gold

882 693 _ _ _

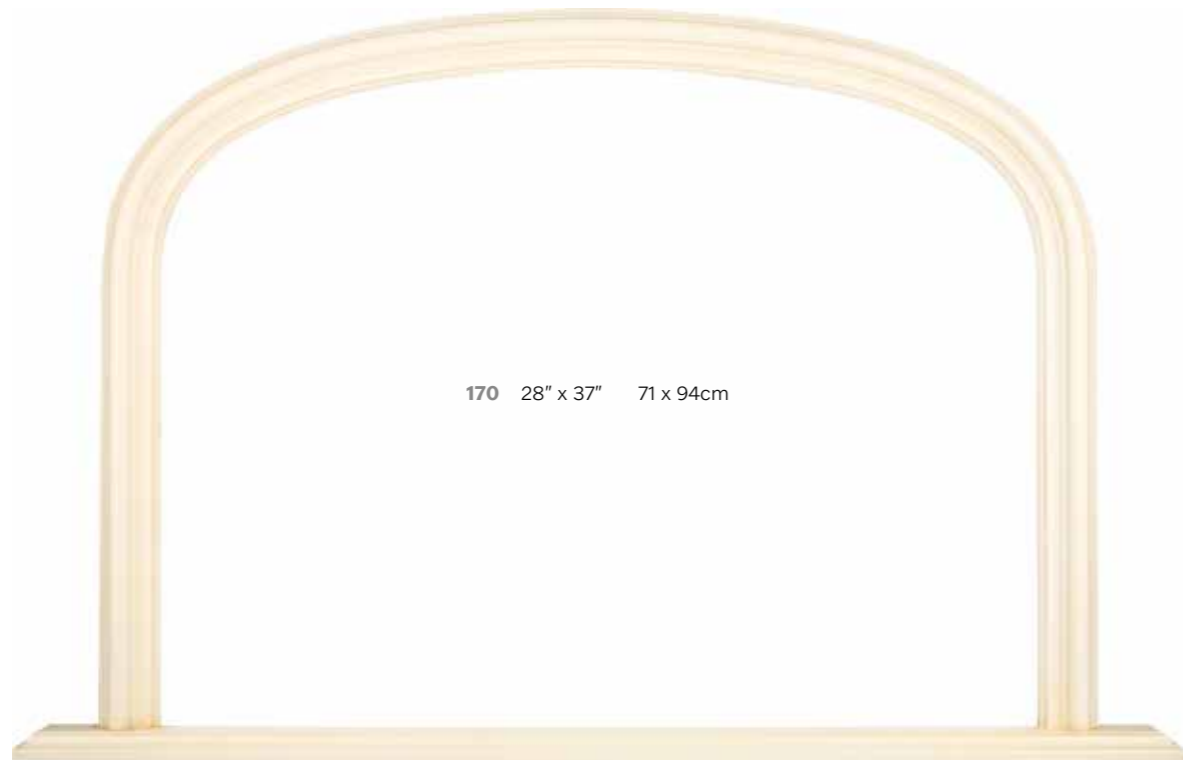

170 28" x 37" 71 x 94cm

2.5" 64mm Ivory

880 157 _ _ _



170 28" x 37" 71 x 94cm

2.5" 64mm Silver

882 348 _ _ _

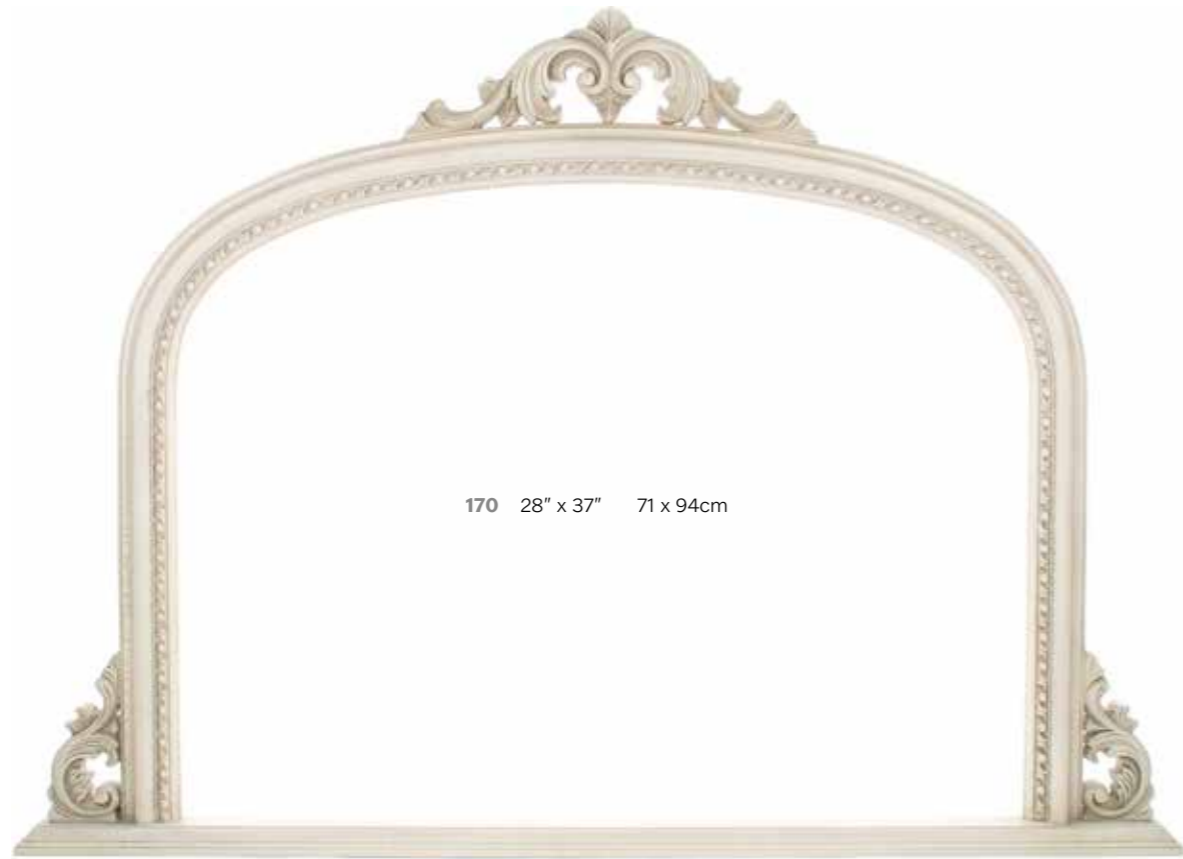

170 28" x 37" 71 x 94cm

2.5" 64mm Ivory

882 127 _ _ _



170 28" x 37" 71 x 94cm

2.5" 64mm White

882 117 _ _ _

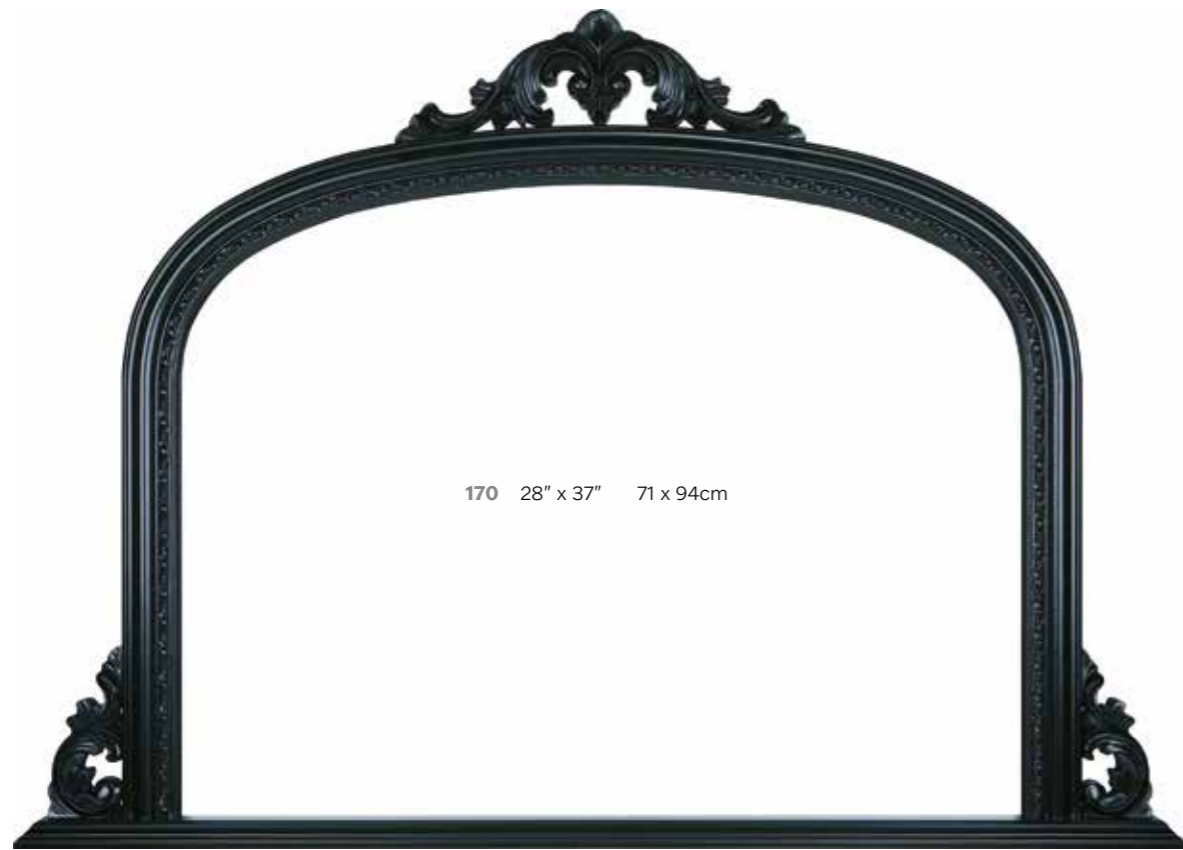

170 28" x 37" 71 x 94cm

2.5" 64mm Black

882 167 _ _ _



170 28" x 37" 71 x 94cm

2.5" 64mm Ivory

882 157 _ _ _

Swept Frames

When you want a traditional frame with that little bit extra, take a look at Larson-Juhl's range of swept frames. Available in gold, silver, black, white or walnut colours, some feature linen slips for a touch of luxury! These beautiful carved frames come in a variety of widths from 1" to 5.5" and some are also available 'pierced'.

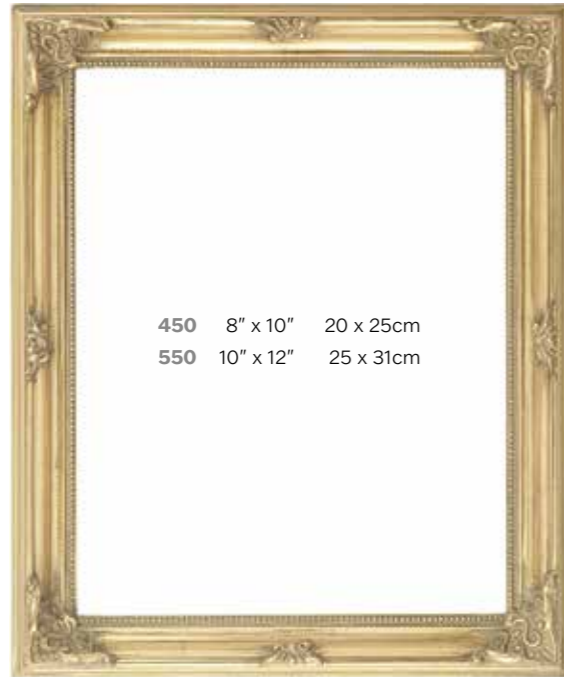

450 8" x 10" 20 x 25cm
550 10" x 12" 25 x 31cm

1" 25mm Gold



550 10" x 12" 25 x 31cm

817 693 ___ 1" 25mm Walnut

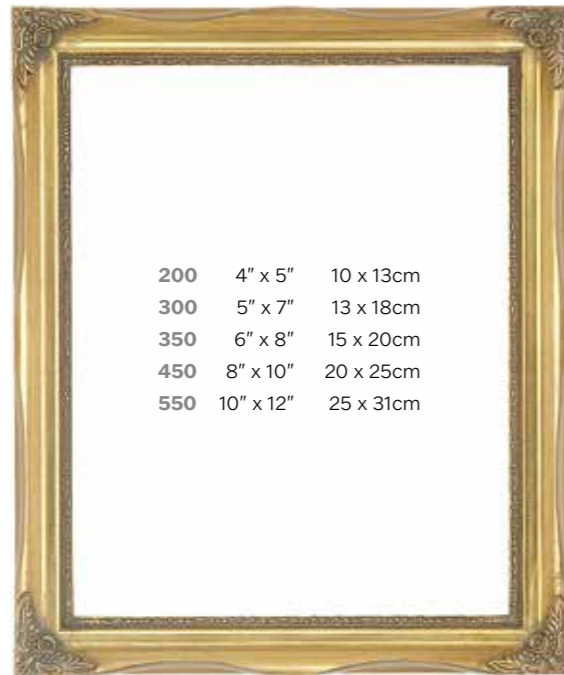

200 4" x 5" 10 x 13cm
300 5" x 7" 13 x 18cm
350 6" x 8" 15 x 20cm
450 8" x 10" 20 x 25cm
550 10" x 12" 25 x 31cm

1" 25mm Gold

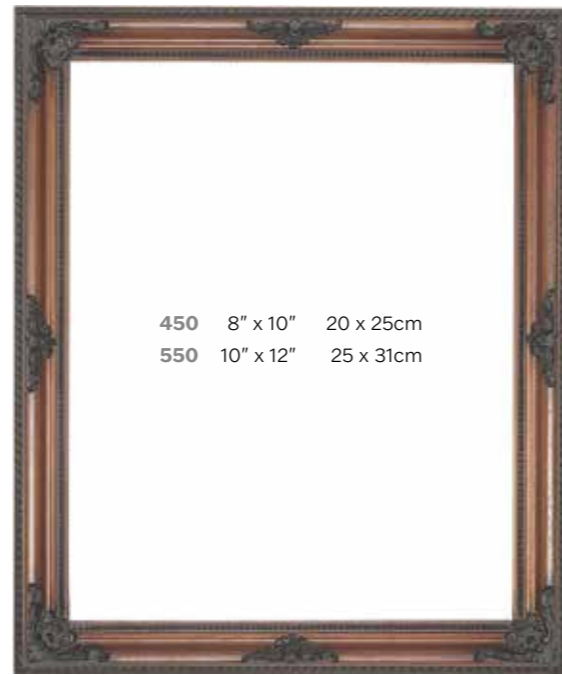

450 8" x 10" 20 x 25cm
550 10" x 12" 25 x 31cm

830 228 ___ 2" 51mm Walnut 806 494 ___

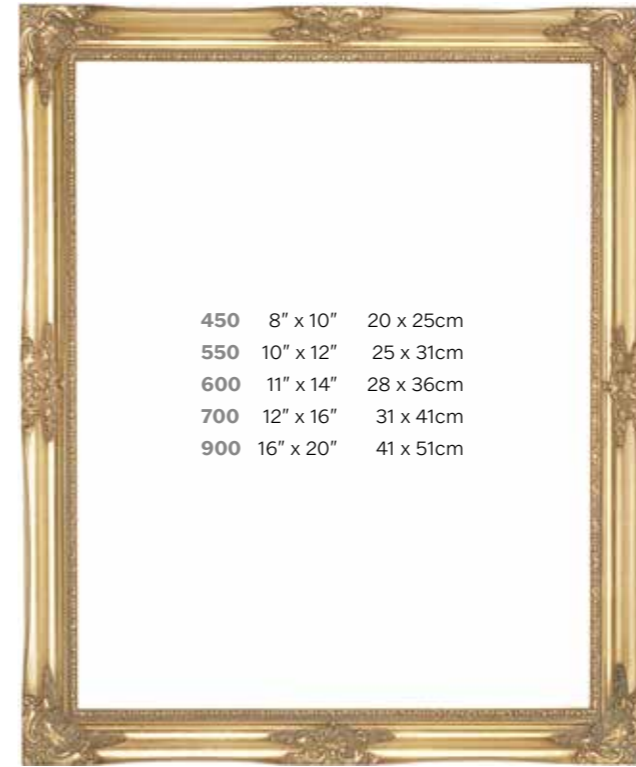

450 8" x 10" 20 x 25cm
550 10" x 12" 25 x 31cm
600 11" x 14" 28 x 36cm
700 12" x 16" 31 x 41cm
900 16" x 20" 41 x 51cm

1.5" 38mm Gold

814 693 ___

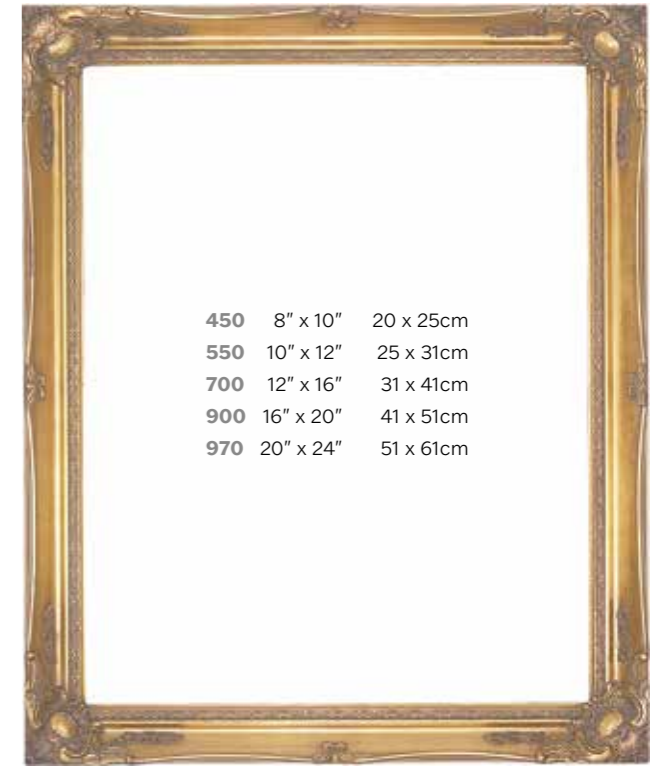

450 8" x 10" 20 x 25cm
550 10" x 12" 25 x 31cm
700 12" x 16" 31 x 41cm
900 16" x 20" 41 x 51cm
970 20" x 24" 51 x 61cm

2" 51mm Gold

678 693 ___

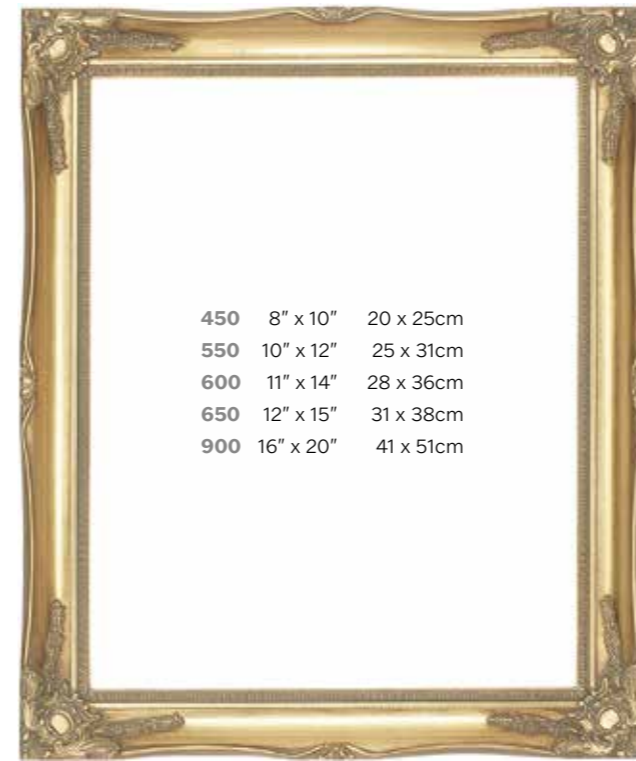

450 8" x 10" 20 x 25cm
550 10" x 12" 25 x 31cm
600 11" x 14" 28 x 36cm
650 12" x 15" 31 x 38cm
900 16" x 20" 41 x 51cm

2.25" 57mm Gold

818 693 ___

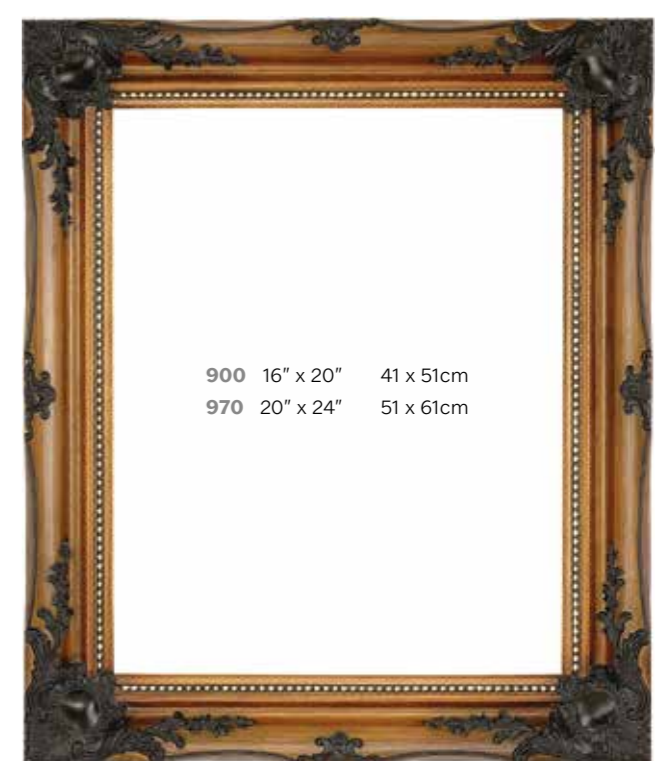

900 16" x 20" 41 x 51cm
970 20" x 24" 51 x 61cm

3" 76mm Walnut with gold beading

819 495 ___

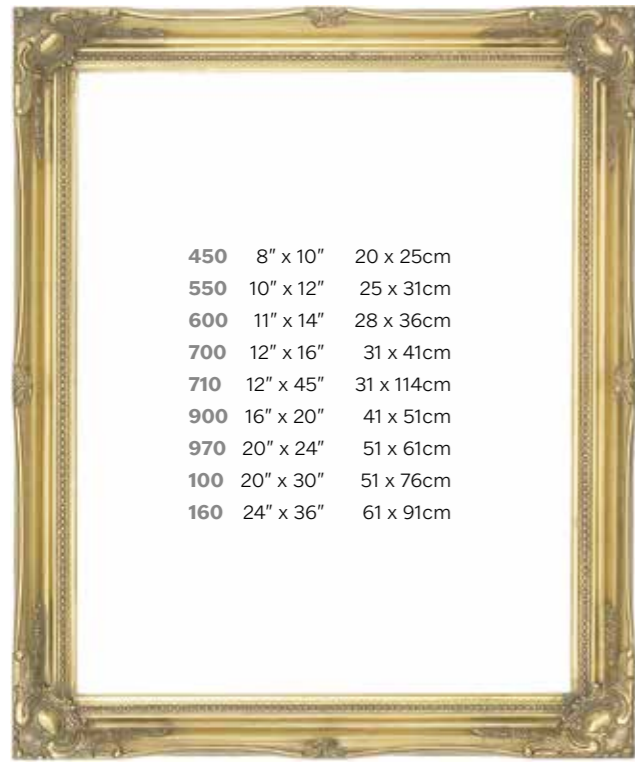

450	8" x 10"	20 x 25cm
550	10" x 12"	25 x 31cm
600	11" x 14"	28 x 36cm
700	12" x 16"	31 x 41cm
710	12" x 45"	31 x 114cm
900	16" x 20"	41 x 51cm
970	20" x 24"	51 x 61cm
100	20" x 30"	51 x 76cm
160	24" x 36"	61 x 91cm

2" 51mm Gold

816 693 _ _ _

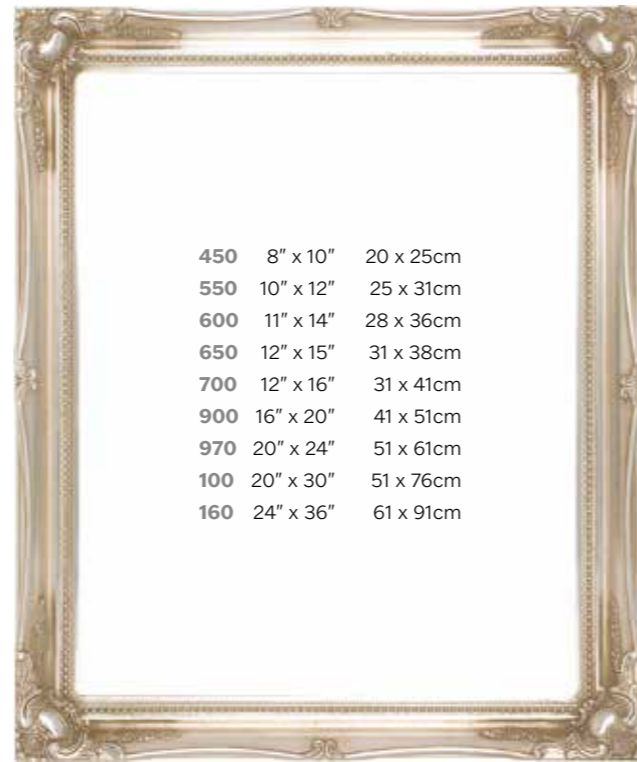

450	8" x 10"	20 x 25cm
550	10" x 12"	25 x 31cm
600	11" x 14"	28 x 36cm
650	12" x 15"	31 x 38cm
700	12" x 16"	31 x 41cm
900	16" x 20"	41 x 51cm
970	20" x 24"	51 x 61cm
100	20" x 30"	51 x 76cm
160	24" x 36"	61 x 91cm

2" 51mm Silver

816 348 _ _ _

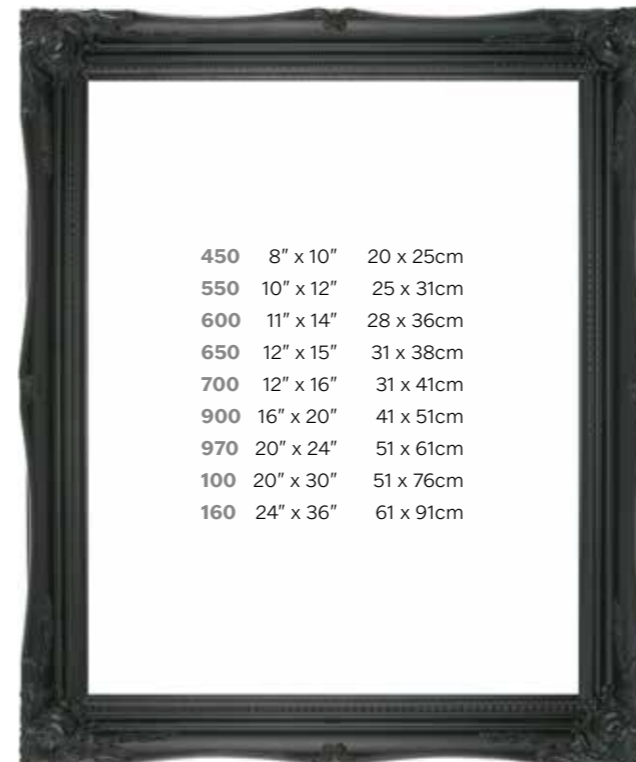

450	8" x 10"	20 x 25cm
550	10" x 12"	25 x 31cm
600	11" x 14"	28 x 36cm
650	12" x 15"	31 x 38cm
700	12" x 16"	31 x 41cm
900	16" x 20"	41 x 51cm
970	20" x 24"	51 x 61cm
100	20" x 30"	51 x 76cm
160	24" x 36"	61 x 91cm

2" 51mm Black

816 167 _ _ _



900	16" x 20"	41 x 51cm
970	20" x 24"	51 x 61cm
100	20" x 30"	51 x 76cm
160	24" x 36"	61 x 91cm
190	24" x 48"	61 x 122cm
230	30" x 40"	76 x 102cm
210	36" x 48"	91 x 122cm

3" 76mm White

829 117 _ _ _



970	20" x 24"	51 x 61cm
-----	-----------	-----------

2" 51mm Walnut with Gold beading

816 495 _ _ _



450	8" x 10"	20 x 25cm
550	10" x 12"	25 x 31cm
650	12" x 15"	31 x 38cm
700	12" x 16"	31 x 41cm
900	16" x 20"	41 x 51cm
970	20" x 24"	51 x 61cm
100	20" x 30"	51 x 76cm
160	24" x 36"	61 x 91cm

2" 51mm Ivory

816 127 _ _ _



450	8" x 10"	20 x 25cm
550	10" x 12"	25 x 31cm
600	11" x 14"	28 x 36cm
650	12" x 15"	31 x 38cm
700	12" x 16"	31 x 41cm
900	16" x 20"	41 x 51cm
970	20" x 24"	51 x 61cm
100	20" x 30"	51 x 76cm
160	24" x 36"	61 x 91cm

2" 51mm White

816 117 _ _ _

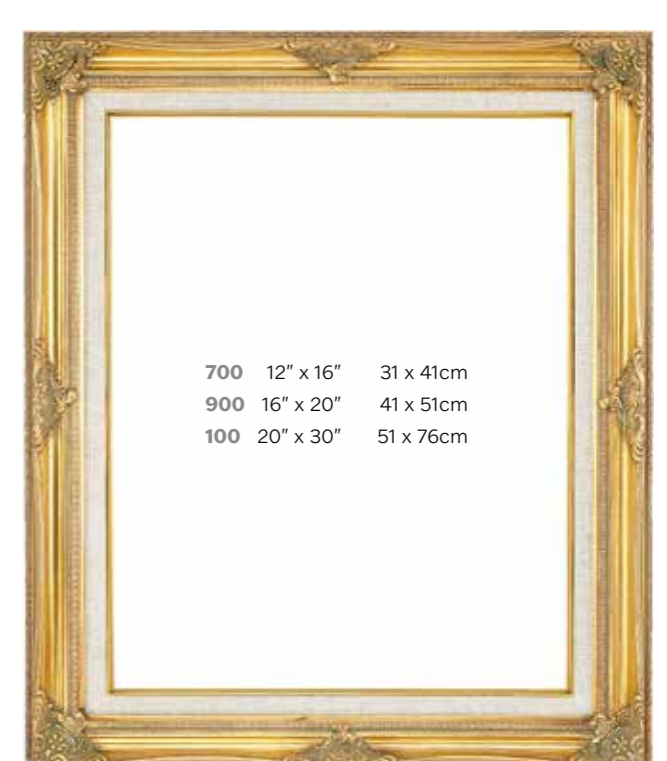

700	12" x 16"	31 x 41cm
900	16" x 20"	41 x 51cm
100	20" x 30"	51 x 76cm

2" 51mm Gold with linen liner

626 693 _ _ _



900	16" x 20"	41 x 51cm
970	20" x 24"	51 x 61cm
100	20" x 30"	51 x 76cm
160	24" x 36"	61 x 91cm
190	24" x 48"	61 x 122cm
230	30" x 40"	76 x 102cm
210	36" x 48"	91 x 122cm

3" 76mm Gold

829 693 _ _ _

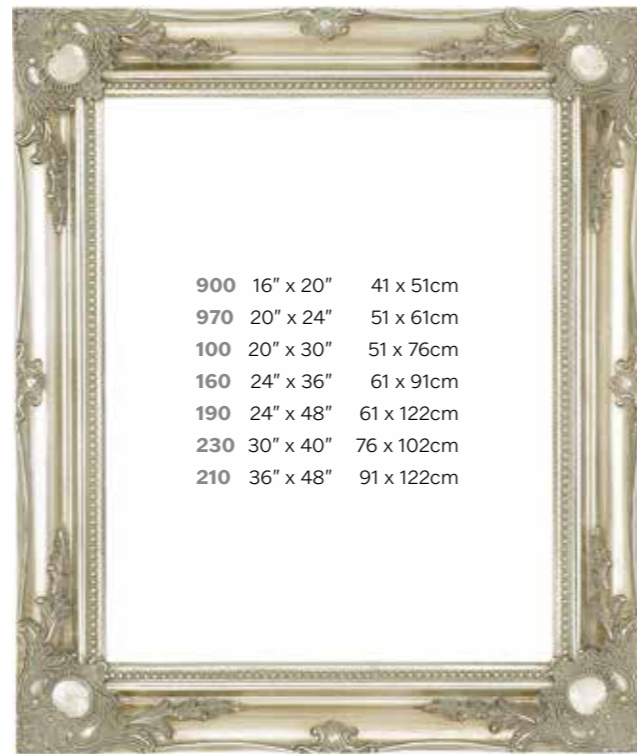

900	16" x 20"	41 x 51cm
970	20" x 24"	51 x 61cm
100	20" x 30"	51 x 76cm
160	24" x 36"	61 x 91cm
190	24" x 48"	61 x 122cm
230	30" x 40"	76 x 102cm
210	36" x 48"	91 x 122cm

3" 76mm Silver

829 348 _ _ _

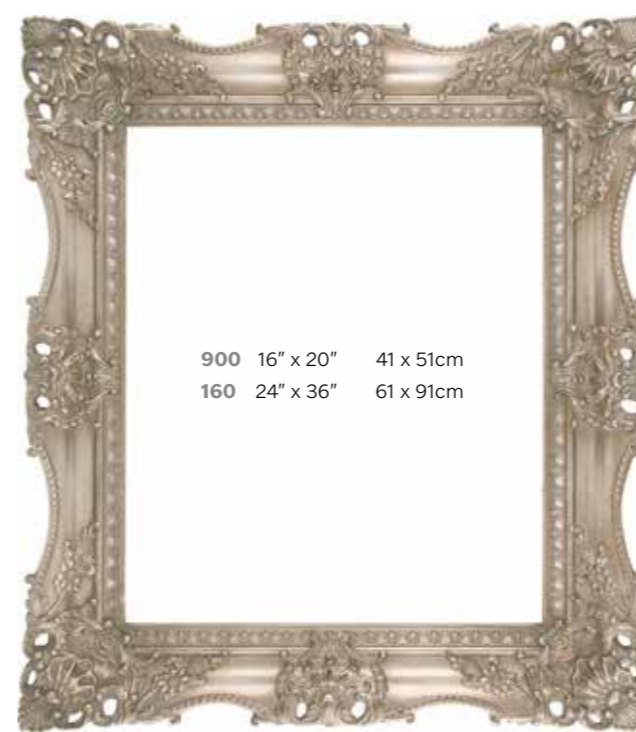

900	16" x 20"	41 x 51cm
160	24" x 36"	61 x 91cm

3.75" 95mm Silver

627 348 _ _ _

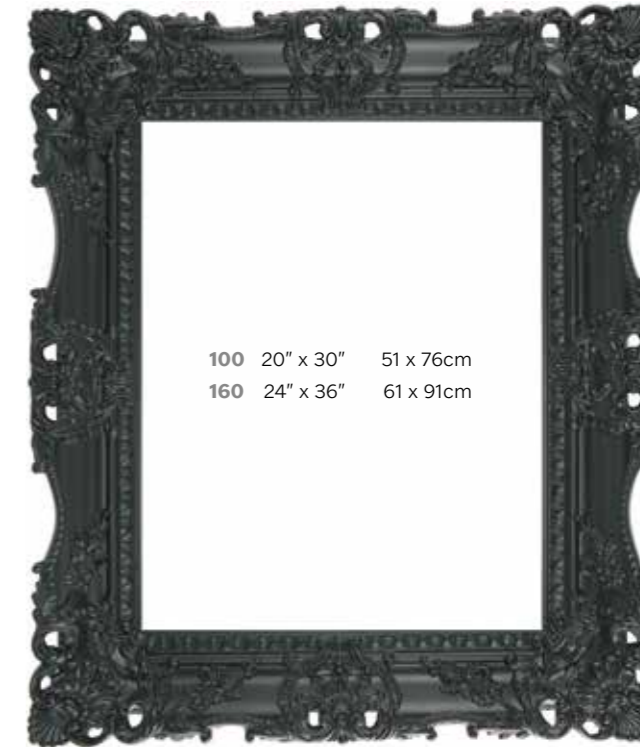

100	20" x 30"	51 x 76cm
160	24" x 36"	61 x 91cm

3.75" 95mm Black

627 167 _ _ _



900	16" x 20"	41 x 51cm
100	20" x 30"	51 x 76cm
160	24" x 36"	61 x 91cm
230	30" x 40"	76 x 102cm
210	36" x 48"	91 x 122cm

3" 76mm Ivory

829 127 _ _ _



900	16" x 20"	41 x 51cm
970	20" x 24"	51 x 61cm
100	20" x 30"	51 x 76cm
160	24" x 36"	61 x 91cm
230	30" x 40"	76 x 102cm
210	36" x 48"	91 x 122cm

3" 76mm Black

829 167 _ _ _

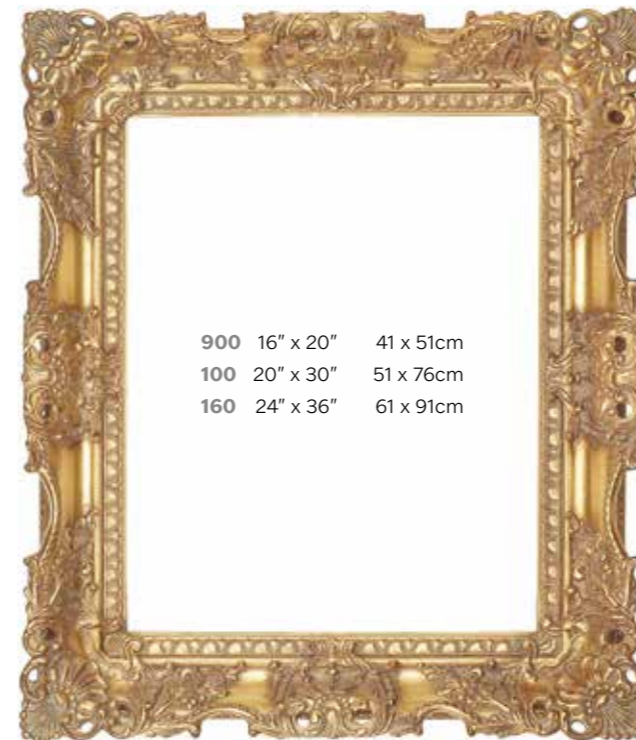

900	16" x 20"	41 x 51cm
100	20" x 30"	51 x 76cm
160	24" x 36"	61 x 91cm

3.75" 95mm Gold Carved

627 693 _ _ _

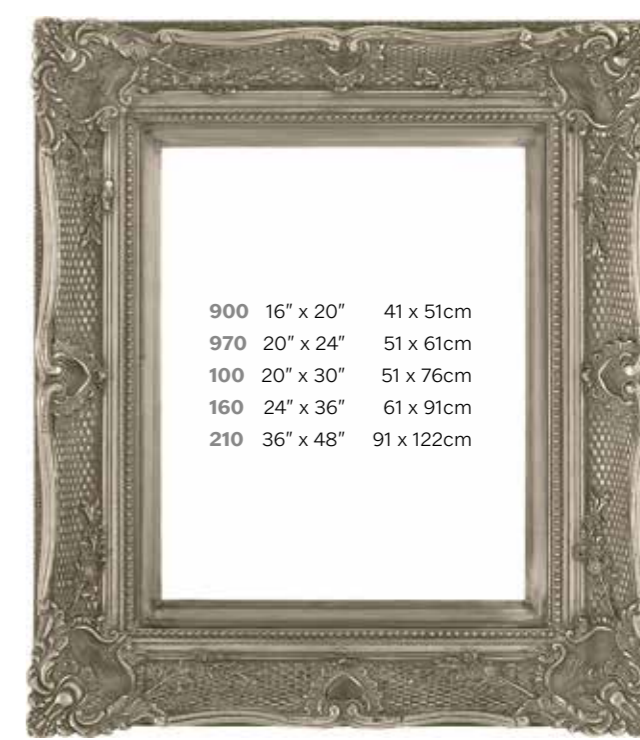

900	16" x 20"	41 x 51cm
970	20" x 24"	51 x 61cm
100	20" x 30"	51 x 76cm
160	24" x 36"	61 x 91cm
210	36" x 48"	91 x 122cm

5.5" 140mm Silver

889 348 _ _ _

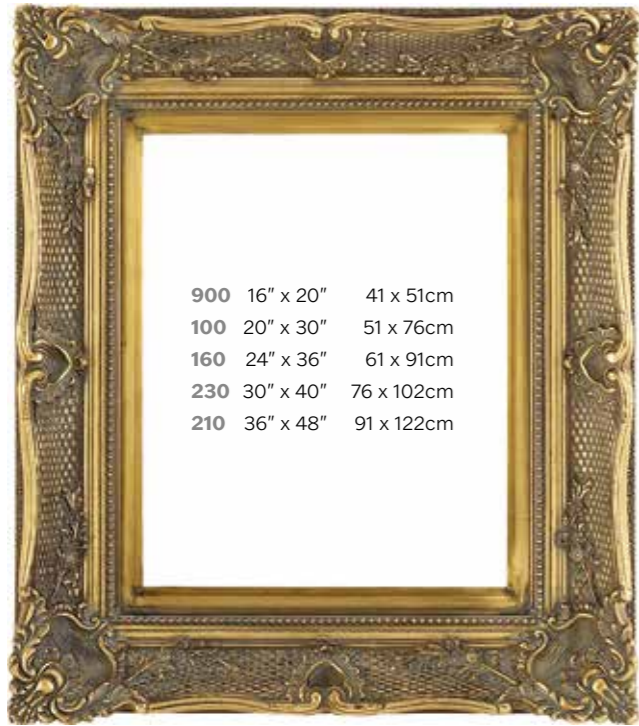

900 16" x 20" 41 x 51cm
 100 20" x 30" 51 x 76cm
 160 24" x 36" 61 x 91cm
 230 30" x 40" 76 x 102cm
 210 36" x 48" 91 x 122cm

5.5" 140mm Gold

889 693 _ _ _



740 12" x 48" 31 x 122cm
 760 12" x 60" 31 x 152cm
 240 24" x 60" 61 x 152cm
 260 36" x 60" 91 x 152cm

3" 76mm White

829 117 _ _ _



240 24" x 60" 61 x 152cm

3" 76mm Black

829 167 _ _ _

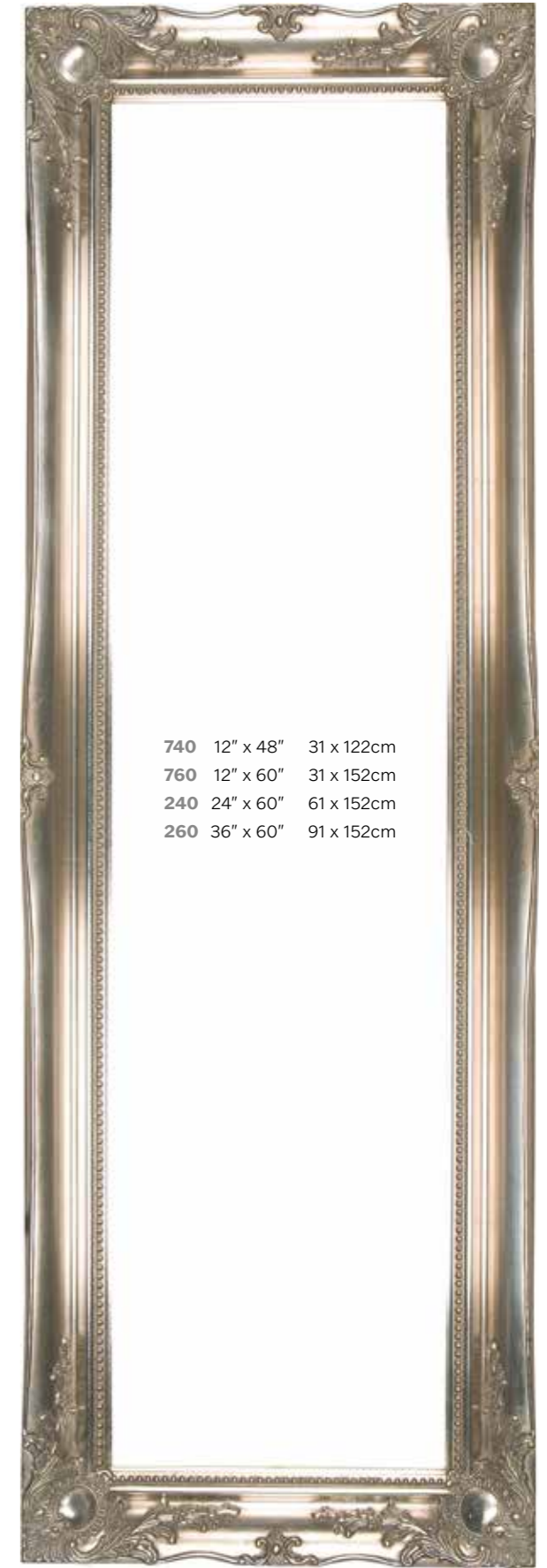

740 12" x 48" 31 x 122cm
 760 12" x 60" 31 x 152cm
 240 24" x 60" 61 x 152cm
 260 36" x 60" 91 x 152cm

3" 76mm Silver

829 348 _ _ _

Oval and Circle Frames

Larson-Juhl's oval and circle frames are perfect for enhancing the soft curves of a mirror or painting.

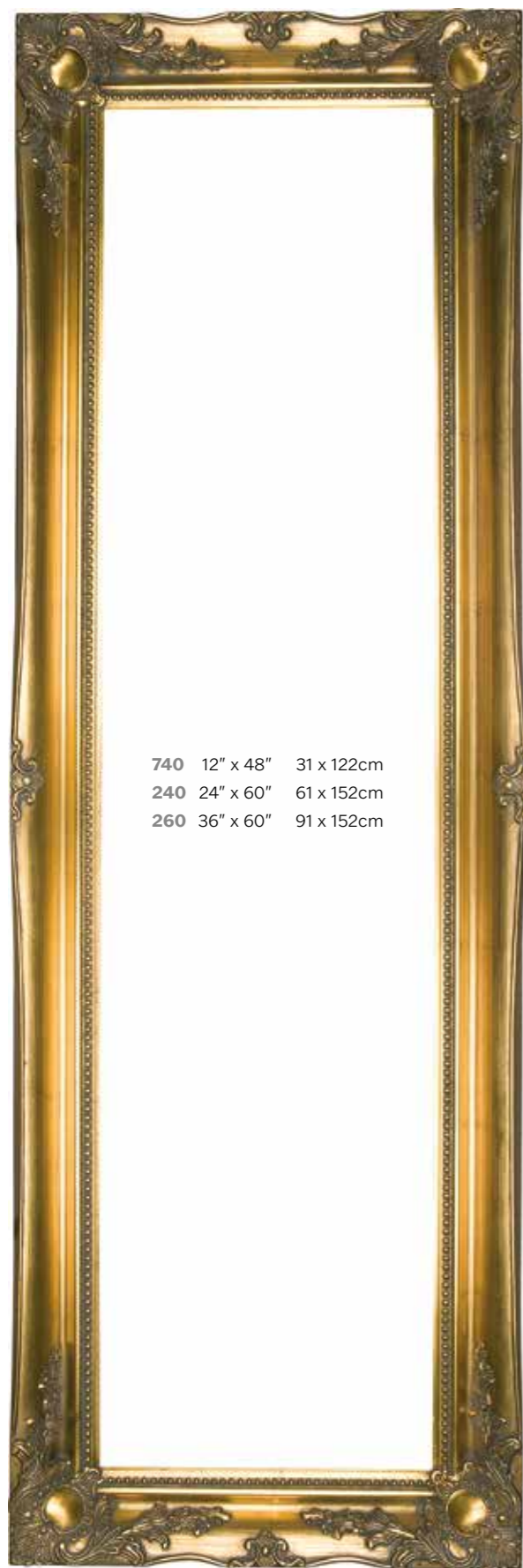

740 12" x 48" 31 x 122cm
 240 24" x 60" 61 x 152cm
 260 36" x 60" 91 x 152cm

3" 76mm Gold

829 693 _ _ _



450 8" x 10" 20 x 25cm

1" 25mm Gold Decorative



700 12" x 16" 31 x 41cm
 900 16" x 20" 41 x 51cm
 970 20" x 24" 51 x 61cm

700 014 _ _ _ 2" 51mm Gold Swept

724 693 _ _ _

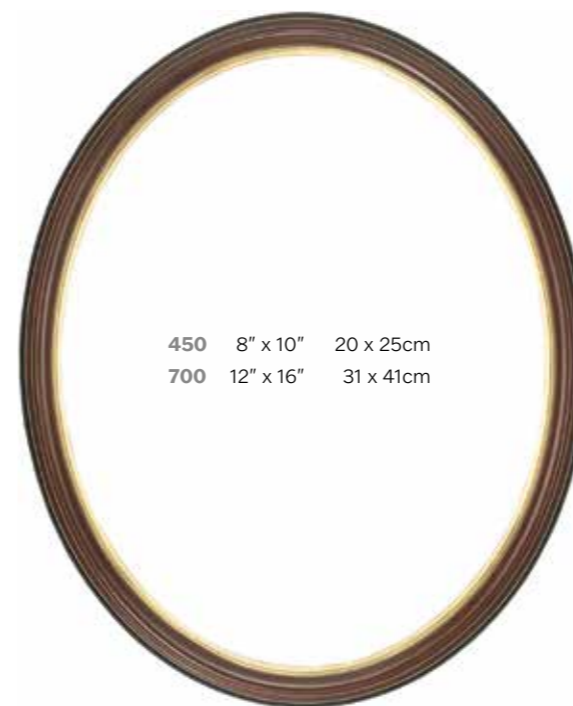

450 8" x 10" 20 x 25cm
 700 12" x 16" 31 x 41cm

1.5" 38mm Brown with Gold edge

839 200 _ _ _



900 16" x 20" 41 x 51cm
 230 30" x 40" 76 x 102cm

4" 101mm Gold Decorative

851 693 _ _ _

Proportional Profiles

A selection of Larson-Juhl's oval and circle frames are available as proportional profiles.

Quite simply, as the size of the frame increases so the width of the profile increases – proportionally. So, if you need a variety of frame sizes in your display but want to keep each in balance with the other, these are ideal.

Oval

25mm profile width	32mm profile width	52mm profile width
9 x 12cm	20 x 25cm	40 x 50cm
13 x 18cm	24 x 30cm	
15 x 20cm	28 x 35cm	
	30 x 40cm	

Circle

25mm profile width	32mm profile width	40mm profile width	52mm profile width
10cm	20cm	40cm	50cm
15cm	24cm		
	30cm		

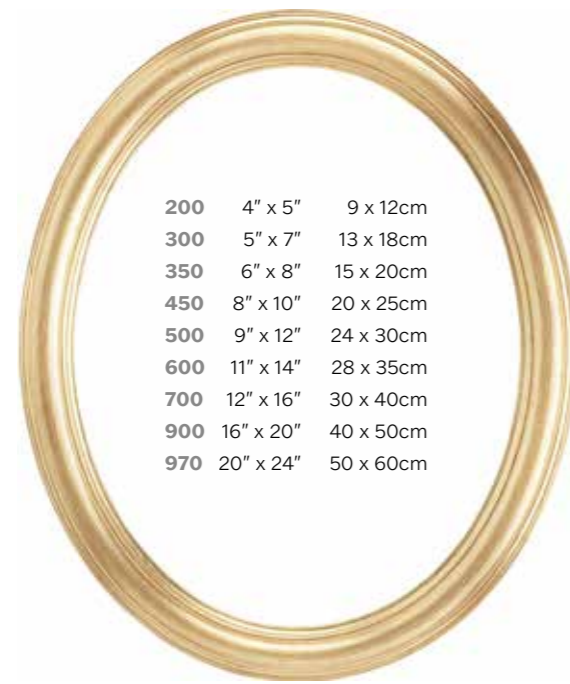

200	4" x 5"	9 x 12cm
300	5" x 7"	13 x 18cm
350	6" x 8"	15 x 20cm
450	8" x 10"	20 x 25cm
500	9" x 12"	24 x 30cm
600	11" x 14"	28 x 35cm
700	12" x 16"	30 x 40cm
900	16" x 20"	40 x 50cm
970	20" x 24"	50 x 60cm

Gold

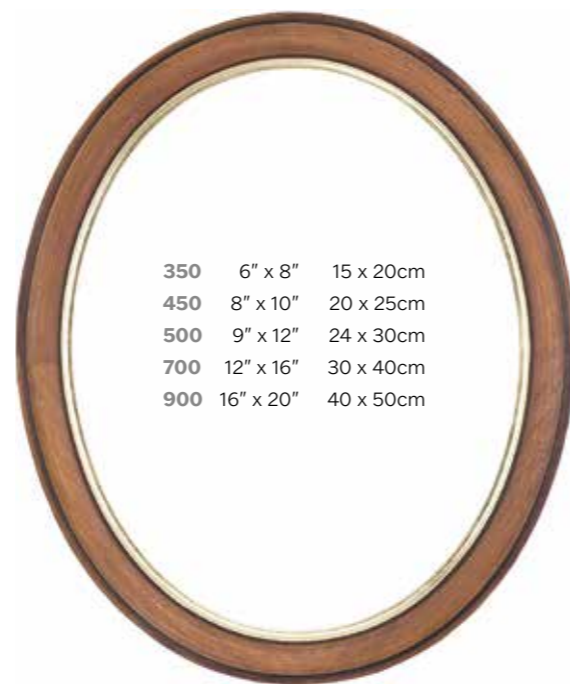

350	6" x 8"	15 x 20cm
450	8" x 10"	20 x 25cm
500	9" x 12"	24 x 30cm
700	12" x 16"	30 x 40cm
900	16" x 20"	40 x 50cm

703 693 _ _ _

Antique Walnut with Gold edge

703 496 _ _ _

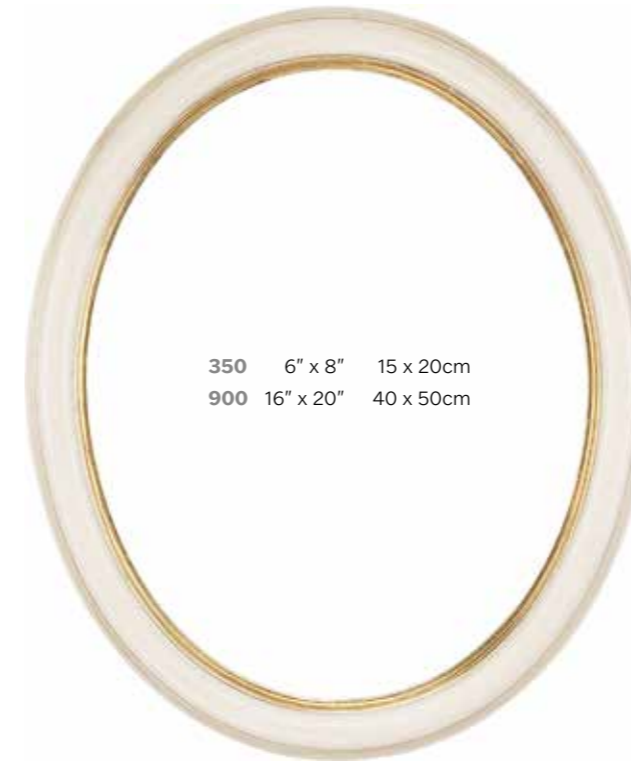

350	6" x 8"	15 x 20cm
900	16" x 20"	40 x 50cm

Antique Ivory with Gold edge

703 157 _ _ _ Barefaced!



Barefaced!

350	6" x 8"	15 x 20cm
500	9" x 12"	24 x 30cm
700	12" x 16"	30 x 40cm
900	16" x 20"	40 x 50cm

703 400 _ _ _

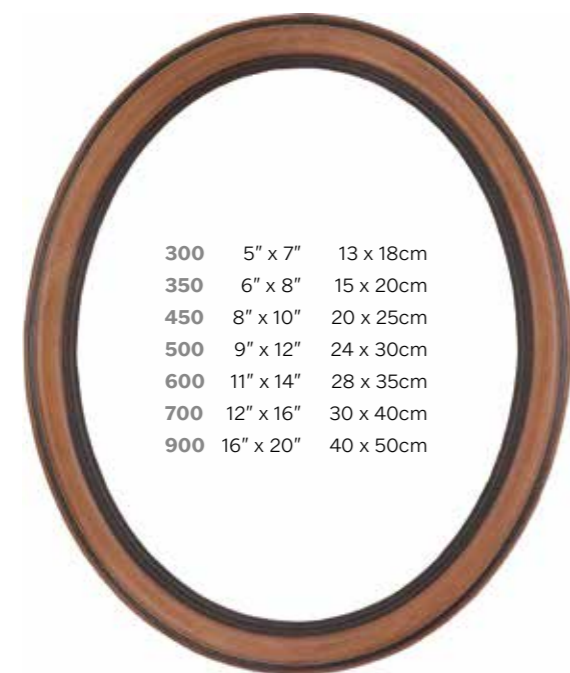

300	5" x 7"	13 x 18cm
350	6" x 8"	15 x 20cm
450	8" x 10"	20 x 25cm
500	9" x 12"	24 x 30cm
600	11" x 14"	28 x 35cm
700	12" x 16"	30 x 40cm
900	16" x 20"	40 x 50cm

Antique Walnut

703 494 _ _ _

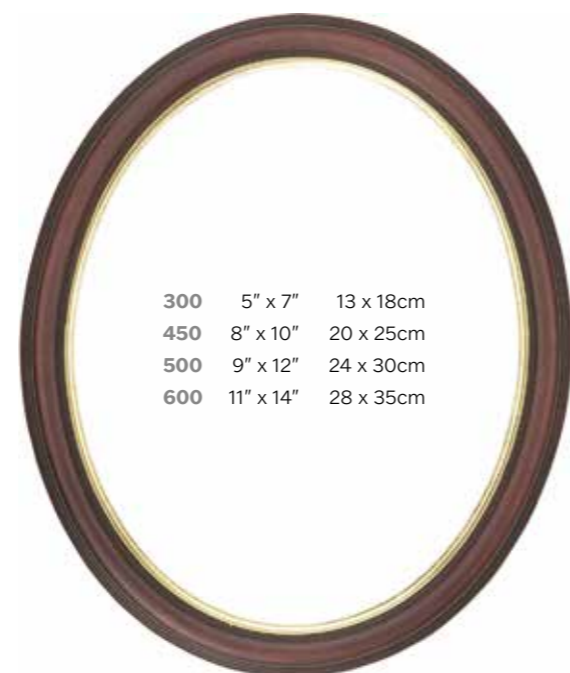

300	5" x 7"	13 x 18cm
450	8" x 10"	20 x 25cm
500	9" x 12"	24 x 30cm
600	11" x 14"	28 x 35cm

Antique Mahogany with Gold edge

703 495 _ _ _



175	4"	10cm
275	6"	15cm
375	8"	20cm
475	9.5"	24cm
575	12"	30cm
675	16"	40cm
775	20"	50cm

Gold

703 693 _ _ _ Antique Walnut with Gold edge



175	4"	10cm
275	6"	15cm
375	8"	20cm
475	9.5"	24cm
575	12"	30cm
675	16"	40cm
775	20"	50cm

703 496 _ _ _

Mouldings

CODE	PAGE
113 300 000	358
113 300 167	245
113 400 000	361
113 900 000	371
114 200 000	360
114 300 000	358
114 300 157	347
114 300 167	245
114 400 000	361
114 800 000	45\359
114 900 000	371
115 167 246	244
115 200 000	360
115 246 000	178
115 300 000	358
115 492 246	312
116 011 000	314
116 015 000	245
116 400 000	362
117 000 127	375
117 000 167	375
119 200 000	360
119 300 000	358
119 400 000	362
120 167 000	247
120 400 000	363
120 492 246	312
121 200 172	178
121 300 000	358
123 360 000	211
125 400 000	363
126 400 000	365
128 127 000	376
128 157 000	376
128 167 000	376
130 127 000	82
130 148 000	82
130 167 000	82
130 220 127	307
130 220 167	307
130 600 492	316
130 600 496	316
130 632 000	82
130 633 000	82
130 634 000	82
130 635 000	82
130 636 000	82

CODE	PAGE
130 637 000	82
130 638 000	82
130 639 000	82
130 640 000	82
130 641 000	82
132 400 000	361
135 127 000	279
135 167 000	242
135 200 000	360
137 200 000	360
137 300 000	358
137 400 000	362
137 500 000	368
140 127 000	274
140 167 000	246
140 220 127	307
140 220 167	307
140 500 000	368
141 200 172	178
142 200 108	178
142 500 000	368
144 000 246	183
144 000 348	221
144 601 000	374
150 000 127	275
150 000 167	246
150 127 000	275
150 167 000	246
150 220 127	307
150 220 167	307
150 632 000	85
150 633 000	85
150 634 000	85
150 635 000	85
150 636 000	85
150 637 000	85
150 638 000	85
150 639 000	85
150 640 000	85
150 641 000	84
150 647 000	85
150 651 000	84
150 652 000	84
150 653 000	84
150 654 000	84
151 000 127	376
151 400 000	376

CODE	PAGE
152 400 000	361
152 453 127	375
152 453 167	375
153 500 000	368
154 300 000	358
155 200 000	360
155 300 000	358
155 400 000	361
155 800 000	45\359
155 900 000	371
156 000 348	221
158 200 000	360
158 300 000	358
159 800 000	45\359
161 000 127	374
161 000 246	374
161 000 348	374
161 200 000	374
161 200 246	374
161 444 000	374
161 900 246	374
163 200 000	360
165 201 246	180
165 201 358	216
165 400 000	364
166 400 000	364
169 400 000	362
175 000 127	274
175 000 167	255
175 127 000	274
175 167 000	255
179 000 101	324
180 300 000	358
182 000 127	275
182 000 167	254
183 100 340	376
184 400 000	363
185 000 127	280
185 000 137	349
185 000 167	255
185 127 000	280
185 157 000	349
185 167 000	258
185 400 000	363
186 400 000	364
189 200 001	324
189 200 005	354

CODE	PAGE
189 200 008	292
192 400 000	363
193 400 000	366
195 190 100	376
195 400 000	364
200 000 127	279
200 000 137	348
200 000 167	253
200 000 499	313
200 400 000	361
201 167 000	242
201 246 000	207
201 348 000	232
201 512 100	355
201 512 101	355
202 100 600	216
202 100 601	216
202 167 000	242
202 167 246	266
202 167 348	266
202 560 127	284
202 560 167	265
202 560 246	192
202 560 348	225
202 800 000	45\359
203 073 101	258
203 073 102	285
203 073 103	293
203 073 104	293
203 073 105	293
203 650 010	312
204 000 358	224
204 494 246	312
206 193 540	222
206 193 640	186
206 193 740	186
206 350 167	245
207 131 100	354
207 131 101	354
207 214 540	222
207 214 640	186
207 214 740	186
207 340 167	243
207 400 000	366
208 400 000	366
208 503 540	222
208 503 640	186

CODE	PAGE
208 503 740	186
209 167 246	244
209 167 348	244
209 283 000	178
209 492 000	318
209 492 246	318
209 496 246	318
209 545 400	318
210 064 613	44\218
210 064 614	44\218
210 064 615	44\266
210 064 681	44\285
210 064 714	44\182
210 200 000	360
210 300 000	358
210 400 000	362
210 900 000	371
211 200 000	360
211 300 000	358
211 310 120	178
211 312 340	178
211 545 400	318
211 800 000	45\359
212 113 477	27\320
212 113 623	27\299
212 113 629	27\261
212 570 167	265
212 570 246	192
213 203 000	291
213 204 000	291
213 247 000	204
213 348 000	231
213 492 246	327
214 500 100	355
214 500 101	355
214 600 012	180
214 600 034	180
214 600 100	180
214 601 012	217
215 130 000	179
215 400 246	202
215 400 500	202
216 127 000	284
216 167 000	266
217 170 530	40\321
217 170 532	40\321
217 170 536	40\321

CODE	PAGE
217 170 540	40\346
217 170 541	40\346
217 170 545	40\319
217 170 546	40\319
217 170 547	40\186
217 170 548	41\249
217 170 549	41\294
217 170 975	26\249
217 170 985	26\347
218 140 620	25\217
218 140 624	25\187
218 140 640	25\187
218 140 720	25\187
218 140 740	25\187
218 150 620	25\217
218 150 624	25\187
218 150 640	25\187
218 150 740	25\187
218 801 238	179
218 801 245	179
219 000 127	277
219 000 137	347
219 000 167	243
219 170 540	346
219 170 541	346
219 170 545	319
219 170 546	319
219 170 547	186
219 170 548	249
219 170 549	294
219 170 975	250
219 170 985	347
219 400 000	361
220 400 000	365
220 406 004	374
220 406 005	374
221 737 004	192
222 073 301	258
222 073 302	285
222 073 303	293
222 073 304	293
222 073 305	293
223 073 201	258
223 073 202	285
223 073 203	293
223 073 204	293
223 073 205	293

Mouldings

CODE	PAGE
224 126 000	179
224 126 238	179
224 126 363	179
224 126 600	179
224 126 700	216
224 203 000	291
224 204 000	291
224 310 000	312
224 400 000	365
224 494 000	327
224 494 246	328
224 600 000	353
225 127 000	274
225 167 000	243
225 410 000	353
225 467 000	292
225 490 000	354
225 496 000	321
226 000 167	268
226 400 000	366
226 655 001	221
226 655 004	192
226 655 005	221
227 400 000	220
228 801 471	17\262
228 801 476	17\229
228 801 652	17\229
228 801 672	18\181
228 801 759	18\181
228 801 772	18\181
229 400 000	362
229 901 480	12\283
229 901 641	12\216
229 901 681	12\216
229 901 741	12\191
229 901 870	36\261
229 901 973	22\298
229 901 976	22\298
229 901 979	22\191
229 901 982	36\294
229 901 986	36\216
230 261 167	242
231 530 148	342
231 530 197	342
231 750 471	14\262
231 750 653	14\217
231 750 673	14\178

CODE	PAGE
231 750 753	14\178
231 750 773	14\178
232 170 530	41\321
232 170 532	41\321
232 170 536	41\321
232 170 540	41\346
232 170 541	41\346
232 170 545	41\319
232 170 546	41\319
232 170 547	41\186
232 170 548	42\249
232 170 549	42\294
232 170 975	26\250
232 170 985	26\347
232 530 148	342
232 530 197	342
233 127 000	280
233 167 000	255
233 170 540	42\346
233 170 541	42\346
233 170 545	42\319
233 170 546	42\319
233 170 547	42\186
233 170 548	42\249
233 170 549	42\294
233 170 975	26\250
233 170 985	26\347
233 250 500	178
234 902 480	12\283
234 902 641	12\218
234 902 681	12\218
234 902 741	12\192
234 902 870	36\261
234 902 973	22\298
234 902 976	22\298
234 902 979	22\192
234 902 982	36\294
234 902 986	36\220
235 000 127	280
235 000 167	253
235 033 000	315
235 034 000	315
235 101 000	243
235 102 000	274
235 127 000	274
235 131 000	321
235 167 000	242

CODE	PAGE
235 220 127	307
235 220 167	307
235 439 167	246
235 439 320	290
235 439 410	290
235 439 430	290
235 439 440	290
235 439 480	290
235 439 490	290
235 439 560	290
235 439 600	216
235 439 601	216
235 467 000	292
236 124 471	382
236 124 653	382
236 124 673	382
236 400 000	362
237	

Mouldings

CODE	PAGE	CODE	PAGE	CODE	PAGE	CODE	PAGE	CODE	PAGE	CODE	PAGE	CODE	PAGE	CODE	PAGE	CODE	PAGE
256 127 000	280	279 811 673	15\188	292 201 740	30\190	305 011 044	374	316 167 000	245	362 329 310	290	389 147 557	35\224	412 127 000	274	429 145 000	183
256 167 000	258	279 811 753	15\188	292 201 786	30\190	305 739 127	348	317 167 246	244	362 329 350	290	389 147 558	35\301	412 167 000	246	429 245 000	227
257 400 000	375	279 811 773	15\188	293 033 000	315	305 739 167	324	317 167 348	244	362 329 370	290	390 200 000	360	412 220 127	307	430 028 000	216
257 853 626	32\233	280 700 496	327	293 310 000	315	305 739 497	324	318 000 127	282	364 453 127	278	390 300 000	358	412 220 167	307	430 033 000	306
257 853 655	233	280 800 496	327	294 202 571	28\267	306 493 107	295	318 000 137	350	364 453 167	255	391 200 000	360	412 410 000	354	430 052 000	306
257 853 675	32\233	280 800 499	327	294 202 581	28\351	306 493 111	296	318 000 167	264	364 453 492	324	396 408 361	292	412 467 000	260	430 105 000	216
257 853 726	213	281 753 616	23\221	294 202 640	30\190	306 493 127	279	319 493 246	313	366 100 000	353	396 408 362	292	412 490 000	354	430 110 000	397
259 167 000	258	281 753 617	23\184	294 202 670	28\267	306 493 167	242	320 167 490	244	366 152 000	355	396 408 363	292	412 496 000	324	430 167 000	242
259 498 246	327	281 753 662	23\225	294 202 686	30\191	306 493 492	321	320 225 246	315	366 167 000	244	396 408 364	292	413 245 000	217	430 220 000	306
260 494 246	317	281 753 717	23\184	294 202 740	30\191	306 494 000	312	320 265 000	312	369 152 000	355	396 408 365	292	414 600 012	180	430 301 000	178
260 496 246	317	281 753 718	23\184	294 202 786	31\191	307 453 107	295	320 265 246	312	370 110 000	397	396 408 366	292	414 601 012	217	430 550 000	306
261 401 832	34\320	282 127 000	278\392	295 203 670	29\267	307 453 111	295	321 427 000	341	370 130 000	397	396 408 367	292	415 202 000	179	430 639 200	306
261 401 834	34\320	282 167 000	392	295 203 686	31\198	307 453 127	278	322 422 000	341	370 250 000	397	396 408 368	292	415 220 127	308\389	432 127 000	281
261 401 836	34\320	282 496 000	392	297 411 626	32\217	307 453 167	242	322 427 000	341	372 005 000	291	397 127 000	308	415 220 167	308\389	432 167 000	251
261 401 838	34\249	282 500 000	392	297 411 629	32\252	307 453 492	322	322 641 260	341	377 940 351	291	397 167 000	308	418 494 000	316	432 167 246	252
264 803 476	19\234	283 502 471	16\262	297 411 727	32\191	308 244 000	179	324 422 000	341	377 940 352	291	398 127 000	308	418 801 238	179	432 167 348	252
264 803 652	20\234	283 502 481	16\283	298 412 626	32\217	308 244 358	216	324 427 000	341	377 940 355	291	398 167 000	308	418 801 245	179	432 201 000	180
264 803 672	20\197	283 502 653	16\234	298 412 629	32\252	308 444 000	179	326 427 000	341	377 940 357	291	400 695 301	178	418 801 248	179	432 247 000	183
264 803 759	21\196	283 502 673	16\188	298 412 727	32\191	308 444 358	216	327 000 127	282	377 940 360	291	401 167 000	242	418 801 249	179	432 348 000	224
264 803 772	21\197	283 502 753	16\188	299 413 626	33\217	309 483 107	295	327 000 167	264	380 110 000	397	402 000 100	353	419 000 127	280	432 436 000	302
265 411 623	38\299	283 502 773	16\189	299 413 629	33\252	309 483 111	296	328 000 107	384	380 130 000	397	402 000 167	242	419 000 137	349	434 000 127	277
265 411 626	38\218	285 244 000	179	299 413 681	33\285	309 483 127	281	328 000 111	384	380 140 000	397	402 000 495	312	419 000 167	260	434 000 167	254
265 411 629	38\218	285 757 616	23\221	299 413 727	33\191	309 483 167	264	328 000 127	383	380 200 000	397	402 167 000	242	419 000 499	323	436 000 127	277
265 411 683	38\299	285 757 617	23\184	300 202 002	256	309 483 492	322	328 000 137	383	380 250 000	397	402 167 015	243	420 245 000	181	436 000 167	246
265 411 727	38\182	285 757 662	23\225	300 202 012	322	310 000 358	233	328 000 167	384	380 300 000	397	402 167 246	244	420 348 000	225	436 000 492	324
266 412 623	38\299	285 757 717	24\184	301 383 107	295	310 502 002	256	328 000 499	384	380 303 000	397	403 000 167	243	421 247 000	178	437 167 000	251
266 412 626	38\230	285 757 718	24\184	301 383 111	295	310 502 011	325	328 400 000	384	380 305 000	397	403 167 000	242	421 348 000	216	438 167 246	251
266 412 629	39\230	286 700 901	359	301 383 127	278	310 502 012	325	329 233 201	248	380 309 000	397	404 167 000	242	421 496 246	312	438 245 000	181
266 412 683	39\299	286 700 902	359	301 383 167	242	311 000 127	279	329 233 204	319	380 310 000	397	404 617 114	376	422 000 127	275	439 000 127	279
266 412 727	39\199	286 700 904	359	301 735 127	348	311 000 167	254	329 233 206	319	380 313 000	397	405 334 110	343	422 000 137	349	439 000 137	348
267 413 727	39\196	286 700 906	359	301 735 497	324	311 493 107	295	330 167 000	243	380 316 000	397	405 334 120	343	422 000 167	263	439 000 167	254
267 499 246	316	286 700 907	359	302 443 107	295	311 493 111	296	332 127 000	275	380 401 000	397	405 334 130	343	422 000 499	323	439 000 499	323
268 499 246	316	286 700 909	359	302 443 111	296	311 493 127	279	332 167 000	260	380 404 000	397	407 000 127	390	423 000 127	275	440 127 000	275
270 310 000	312	287 127 000	279\393	302 443 127	278	311 493 167	254	332 400 000	362	383 202 951	244	407 000 167	390	423 000 137	350	440 167 000	260
271 310 000	314	287 167 000	249\393	302 443 157	349	311 493 492	324	337 127 000	275	383 202 952	181	408 127 000	275	423 000 167	263	440 227 000	245
272 083 310	223	290 120 000	396	302 443 167	242	312 341 000	242	337 167 000	260	383 202 953	217	408 167 000	259	424 490 246	313	440 400 000	219
272 083 330	223	290 140 000	396	302 443 492	322	312 731 460	306	337 400 000	361	383 202 954	181	408 348 000	221	424 494 000	313	440 601 000	185
273 496 246	316	290 170 000	396	302 736 127	348	312 741 000	242	338 400 000	361	384 403 951	244	408 400 000	361	425 494 246	313	441 127 000	274
277 501 471	14\262	290 230 000	396	302 736 497	325	312 781 000	242	339 502 441	256	384 403 952	181	410 027 025	244	426 430 000	179	441 167 000	260
277 501 481	14\283	290 250 000	396	303 423 107	295	314 000 246	183	339 502 443	223	384 403 953	219	410 110 000	397	426 494 000	313	441 227 000	245
277 501 653	14\220	291 246 000	192	303 423 111	295	314 000 358	224	340 542 711	256	384 403 954	181	410 145 000	225	427 220 000	306	441 400 000	219
277 501 673	14\188	291 348 000	228	303 423 127	278	315 492 246	313	340 542 712	224	385 200 000	360	410 245 000	195	427 310 000	306	441 496 000	324
277 501 753	15\188	292 201 571	28\256	303 423 157	347	315 920 201	31\226	344 302 911	256	385 300 000	358	410 250 000	397	427 550 000	306	441 600 000	185
277 501 773	15\188	292 201 581	28\351	303 423 167	242	315 920 202	31\226	344 302 914	182	385 800 000	45\359	411 000 127	281	427 625 600	306	441 700 000	219
279 811 471	15\262	292 201 640	30\190	303 423 492	322	315 920 204	31\226	352 453 127	278	385 900 000	371	411 000 167	254	427 639 200	306	442 139 246	178
279 811 481	15\283	292 201 670	28\256	304 921 450	306	315 920 206	31\226	352 453 167	243	389 147 551	35\300	411 167 003	48\248	428 000 127	281	442 227 000	245
279 811 653	15\220	292 201 686	30\190	305 011 043	374	315 920 207	31\226	354 511 130	326	389 147 552	35\301	411 167 007	48\248	428 000 167	253	442 400 000	219

Mouldings

CODE	PAGE	CODE	PAGE	CODE	PAGE	CODE	PAGE	CODE	PAGE	CODE	PAGE	CODE	PAGE	CODE	PAGE	CODE	PAGE
362 329 310	290	389 147 557	35\224	412 127 000	274	429 145 000	183	442 600 000	185								
362 329 350	290	389 147 558	35\301	412 167 000	246	429 245 000	227	442 601 000	185								
362 329 370	290	390 200 000	360	412 220 127	307	430 028 000	216	442 700 000	219								
364 453 127	278	390 300 000	358	412 220 167	307	430 033 000	306	443 227 000	265								
364 453 167	255	391 200 000	360	412 410 000	354	430 052 000	306	444 244 000	179								
364 453 492	324	396 408 361	292	412 467 000	260	430 105 000	216	444 348 000	217								
366 100 000	353	396 408 362	292	412 490 000	354	430 110 000	397	445 227 000	245								
366 152 000	355	396 408 363	292	412 496 000	324	430 167 000	242	445 400 000	219								
366 167 000	244	396 408 364	292	413 245 000	217	430 220 000	306	445 601 000	185								
369 152 000	3																

Mouldings

CODE	PAGE	CODE	PAGE	CODE	PAGE	CODE	PAGE	CODE	PAGE
454 202 111	245	476 000 150	291	508 400 000	383	531 167 000	247	629 247 000	182
454 496 000	313	476 720 000	291	510 499 273	312	532 167 000	253	629 348 000	223
454 498 000	313	476 760 000	291	511 000 127	386	535 000 127	377	630 247 000	207
454 498 246	313	476 770 000	244	511 000 137	386	535 000 137	377	630 348 000	230
455 167 000	251	482 000 127	278	511 000 167	386	535 000 167	377	632 247 000	210
455 167 246	252	482 000 137	348	511 000 499	386	537 000 127	377	632 348 000	235
455 167 348	251	482 000 167	253	511 400 000	386	537 000 137	377	635 547 000	189
455 247 000	183	482 000 499	323	513 127 000	389	537 000 167	377	635 548 000	227
455 348 000	216	482 167 000	253	513 167 000	389	560 920 247	189	636 547 000	189
455 436 000	302	482 247 000	178	513 287 000	389	561 910 348	222	636 548 000	227
455 494 246	313	486 000 111	296	514 100 000	208	561 920 247	189	637 547 000	189
456 000 167	246	486 000 127	282	515 127 000	387	590 006 000	398	637 548 000	227
457 000 127	375	486 000 137	350	515 167 000	387	590 012 000	398	638 127 000	380
457 000 167	375	486 000 167	255	517 127 000	278	590 170 000	398	638 167 000	380
458 201 105	291	486 245 000	195	517 167 000	260	590 250 000	398	638 400 000	380
458 201 107	291	487 000 127	279	519 127 000	277	594 500 000	48\369	639 127 000	381
458 498 000	312	487 000 137	348	519 167 000	251	596 500 000	48\369	639 167 000	381
458 498 246	312	491 246 000	178	521 167 000	249	600 006 000	398	640 247 000	204
459 246 000	180	492 000 127	279	522 127 000	277	600 012 000	398	640 348 000	226
460 000 167	246	492 000 137	347	522 167 000	249	600 170 000	398	641 246 000	208
461 244 000	179	492 000 167	253	523 127 000	277	600 250 000	398	642 247 000	182
461 244 358	216	492 000 499	313	523 167 000	249	601 127 000	286	642 348 000	223
466 000 111	296	492 246 000	180	526 015 127	276	601 167 000	268	642 795 112	207
466 000 127	278	492 430 000	180	526 015 167	246	602 247 000	210	650 842 246	211
466 000 137	347	494 000 127	375	526 020 127	276	605 348 000	231	658 348 000	231
466 000 167	253	494 000 137	375	526 020 167	246	606 127 000	285	659 247 000	208
466 000 499	323	494 000 167	375	526 025 127	276	606 348 000	235	666 126 000	212
470 246 000	183	494 000 499	375	526 025 167	246	608 247 000	213	670 110 000	398
470 348 000	228	494 127 358	307	526 030 127	276	611 127 000	380	670 247 000	207
471 000 107	297	495 000 127	375	526 030 167	247	611 167 000	380	676 358 000	225
471 000 111	297	495 000 167	376	526 040 127	276	612 247 000	193	680 110 000	398
471 000 127	281	497 000 127	282	526 040 167	247	612 348 000	228	682 246 000	202
471 000 137	349	497 000 137	350	526 127 015	276	614 247 000	178	682 358 000	226
471 000 167	255	497 000 167	259	526 127 020	276	614 348 000	217	683 246 000	202
471 000 499	323	498 202 000	178	526 127 025	276	617 348 000	217	683 358 000	217
473 000 107	297	498 302 000	216	526 127 030	276	618 247 000	178	684 117 246	195
473 000 111	297	499 202 000	178	526 127 035	276	618 348 000	216	684 167 348	261
473 000 127	281	499 302 000	216	526 127 040	277	619 127 000	380	691 246 000	202
473 000 137	349	500 110 000	397	526 167 015	247	619 167 000	380	691 358 000	218
473 000 167	255	501 167 000	251	526 167 020	247	619 400 000	380	692 247 000	202
473 000 499	323	502 200 400	193	526 167 025	247	620 348 000	231	692 348 000	217
474 246 000	183	504 246 000	189	526 167 030	247	621 247 000	180	698 348 000	232
474 348 000	228	507 167 000	265	526 167 035	247	621 348 000	216	699 247 000	181
475 167 012	244	508 127 000	383	526 167 040	247	624 348 000	228	699 348 000	218
475 167 034	244	508 167 000	383	529 127 000	277	627 157 000	193	701 167 000	269
476 000 130	291	508 167 246	383	529 167 000	247	627 247 000	193	702 004 246	202
476 000 140	291	508 167 348	383	530 167 000	253	627 348 000	226	704 157 000	352

Mouldings

CODE	PAGE	CODE	PAGE	CODE	PAGE	CODE	PAGE	CODE	PAGE
705 157 000	352	740 500 000	46\368	787 500 000	47\368	860 115 000	400	991 043 115	334
706 249 000	268	741 000 247	204	788 500 000	47\368	860 130 000	400	991 060 113	336
708 157 000	352	741 000 348	226	790 287 000	326	860 140 000	400	991 060 115	334
709 545 400	317	742 246 000	206	791 287 000	326	860 160 000	400	991 060 116	332
710 545 400	318	744 000 246	208	792 500 000	47\368	860 170 000	401	991 060 117	332
711 545 400	318	747 500 000	46\369	793 246 000	204	860 200 000	401	991 063 115	334
712 127 000	274	753 257 000	351	793 500 000	46\370	860 220 000	401	991 063 116	332
712 167 000	246	753 287 000	325	794 500 000	46\370	860 230 000	401	991 063 117	332
715 146 000	182	754 000 152	348	796 500 000	47\370	860 250 000	401	991 064 115	334
715 148 000	222	755 257 000	351	830 500 000	368	860 260 000	401	991 075 115	334
715 167 000	263	755 287 000	325	840 110 000	399	860 280 000	401	991 079 113	336
716 918 600	206	756 257 000	352	840 120 000	399	860 300 000	401	991 079 115	334
718 430 000	180	756 287 000	325	840 130 000	399	860 310 000	401	991 079 116	332
720 225 246	315	757 127 000	287	840 140 000	399	887 073 000	312	991 079 117	332
722 047 000	244	757 167 000	269	840 160 000	399	887 073 880	312	991 079 242	303
723 998 000	202	758 257 000	351	840 170 000	399	890 011 000	401	991 079 243	303
724 490 246	313	758 287 000	326	840 200 000	399	890 073 000	312	991 083 113	336
725 071 000	284	759 257 000	351	840 220 000	399	890 073 880	312	991 083 115	334
725 073 000	257	760 494 246	317	840 230 000	399	890 130 000	401	991 083 116	332
725 075 000	205	761 257 000	351	840 250 000	399	898 073 880	314	991 083 117	332
725 077 000	205	761 998 000	202	840 260 000	399	917 700 000	238	991 083 243	303
725 079 000	227	765 430 000	180	840 300 000	399	917 705 000	238	991 093 115	334
726 490 246	313	766 610 246	208	840 310 000	399	921 700 000	238	991 093 116	332
726 492 246	313	767 500 000	47\369	840 330 000	399	921 705 000	238	991 096 113	336
726 496 246	313	768 567 000	328	840 370 000	399	922 700 000	238	991 096 115	335
727 246 000	195	770 127 000	284	850 011 000	399	922 705 000	238	991 096 116	332
727 358 000	229	770 167 000	264	850 012 000	399	928 700 000	238	991 096 117	332
730 146 000	182	770 241 000	207	850 100 000	399	929 700 000	238	991 099 115	335
730 148 000	223	770 341 000	230	850 103 000	399	930 705 000	238	991 099 116	332
730 167 000	263	771 246 000	206	850 105 000	399	941 083 049	287	991 099 117	332
732 680 000	202	771 348 000	230	850 123 000	400	941 083 086	267	991 100 242	303
734 146 000	182	771 500 000	47\369	850 130 000	400	942 006 054	387	991 100 243	303
734 148 000	223	773 500 000	47\369	850 140 000	400	942 006 055	388	991 100 247	303
734 167 000	263	774 073 880	318	850 150 000	400	942 006 086	388	991 116 113	337
735 101 000	255	776 100 246	205	850 160 000	400	943 033 054	261	991 116 115	335
735 102 000	277	776 101 246	205	850 170 000	400	946 043 045	261	991 116 116	333
737 071 000	284	776 200 246	205	850 200 000	400	946 043 048	350	991 116 117	332
737 073 000	257	776 300 246	206	850 220 000	400	947 043 045	261	991 132 115	335
737 075 000	209	778 972 100	206	850 230 000	400	947 043 048	350	991 132 116	333
737 077 000	209	781 220 000	180	850 250 000	400	949 073 054	222	991 137 242	303
737 079 000	227	781 500 000	47\369	850 260 000	400	949 073 055	185	991 137 243	303
739 287 000	326	782 073 000	257	850 300 000	400	990 110 000	401	991 174 115	336
740 071 000	284	782 075 000	205	850 370 000	400	990 120 000	401	991 174 117	336
740 073 000	257	782 077 000	205	860 011 000	400	990 130 000	401	991 238 115	335
740 075 000	205	782 079 000	227	860 012 000	400	990 250 000	401	991 238 117	334
740 077 000	205	784 500 000	47\368	860 100 000	400	991 033 115	335\374	991 242 243	384
740 079 000	227	785 246 000	202	860 101 000	400	991 035 115	335\374	991 243 242	384

Mouldings

CODE	PAGE	CODE	PAGE	CODE	PAGE	CODE	PAGE
991 243 243	384	220 OAC 805	406	664 9BU	139	722 OAC 892	406
991 245 113	337\385	220 OAC 806	406	664 9GN	139	732 OAG	178
991 245 115	335\385	220 OAC 808	406	664 9IV	139	749 OAC 875	409
991 245 116	333\385	220 OAC 809	406	667 0BK	139	749 OAC 876	409
991 245 117	334\385	220 OAC 811	407	667 0BU	139	771 OAC 885	405
991 246 115	335\385	220 OAC 891	407	667 0GN	139	771 OAC 887	405
991 246 116	333\385	220 OAC 892	407	667 0IV	139	771 OAC 888	405
991 246 117	334\386	242 3IV	347	675 OWA	322	772 OAC 885	407
991 247 115	335\385	316 4EG	206	683 IB	112	772 OAC 887	407
991 247 117	334\385	332 9AB	290	683 IG	112	772 OAC 888	407
991 260 115	339	332 9BK	290	683 IS	112	774 OAC 897	407
991 260 116	338	332 9BU	290	700 OWA	322	775 OAC 895	408
991 260 117	337	332 9GN	290	720 OAC 041	404	775 OAC 896	408
991 260 140	339	332 9MA	290	720 OAC 801	404	861 IG	113
991 260 141	338	332 9PU	290	720 OAC 802	404	861 IS	113
991 260 142	338	332 9RD	290	720 OAC 803	404	947 5OG	317
991 261 115	339	332 9SA	290	720 OAC 805	404	967 5WG	317
991 261 117	337	332 9TK	290	720 OAC 806	404	KL8 590 01	309
991 261 140	339	332 9WA	290	720 OAC 807	404	KL8 590 02	309
991 261 141	338	334 1BK	243	720 OAC 808	404	KL8 690 01	309
991 261 142	338	334 1SA	353	720 OAC 809	404	KL8 690 02	309
991 262 115	339	334 1WA	322	720 OAC 810	404	SP2 257 SP	353
991 262 117	337	334 1WH	274	720 OAC 851	404		
991 262 140	339	334 2BK	243	720 OAC 863	404		
991 262 141	339	334 2SA	353	720 OAC 864	404		
991 262 142	338	334 2WA	322	720 OAC 867	404		
047 5WG	317	334 2WH	274	720 OAC 868	404		
070 1AG	178	334 4BK	243	720 OAC 891	404		
070 1AW	312	334 4SA	353	720 OAC 892	404		
147 7AN	354	334 4WA	322	721 OAC 041	405		
147 7AP	354	334 4WH	274	721 OAC 801	405		
151 IB	111	334 6BK	243	721 OAC 802	405		
151 IG	111	354 1ED	205	721 OAC 805	405		
151 IS	111	354 3AB	290	721 OAC 806	405		
153 IB	111	354 3SA	354	721 OAC 807	405		
153 IG	111	354 3TK	354	721 OAC 808	405		
153 IS	111	373 IB	111	721 OAC 809	405		
160 OAG	181	373 IG	111	721 OAC 811	405		
160 OGG	181	373 IS	111	721 OAC 891	405		
160 ORG	181	392 1AG	179	721 OAC 892	405		
180 OAG	180	523 0WW	363	722 OAC 713	406		
180 OGN	180	615 1LI	376	722 OAC 714	406		
180 OIV	180	624 8BG	244	722 OAC 801	406		
180 ORG	180	643 IB	112	722 OAC 805	406		
180 OSB	217	643 IG	112	722 OAC 806	406		
219 OAC 579	408	643 IS	112	722 OAC 808	406		
219 OAC 580	408	664 9BK	139	722 OAC 811	406		

Ready Made Frames

CODE	PAGE	CODE	PAGE	CODE	PAGE	CODE	PAGE	CODE	PAGE	CODE	PAGE
139 348 100	412	703 496 375	431	816 117 900	423	819 495 970	421	830 228 350	420		
139 348 160	412	703 496 450	430	816 117 970	423	829 117 100	423	830 228 450	420		
139 348 230	412	703 496 475	431	816 127 100	422	829 117 160	423	830 228 550	420		
139 348 450	412	703 496 500	430	816 127 160	422	829 117 190	423	839 200 450	429		
139 348 700	412	703 496 575	431	816 127 450	422	829 117 210	423	839 200 700	429		
139 348 900	412	703 496 675	431	816 127 550	422	829 117 230	423	851 693 230	426		
139 693 100	412	703 496 700	430	816 127 650	422	829 117 240	426	851 693 900	429		
139 693 160	412	703 496 775	431	816 127 700	422	829 117 260	426	860 157 700	411		
139 693 230	412	703 496 900	430	816 127 900	422	829 117 740	426	860 157 900	411		
139 693 700	412	703 693 175	431	816 127 970	422	829 117 760	426	860 167 900	411		
139 693 900	412	703 693 200	430	816 167 100	423	829 117 900	423	862 348 160	412		
626 693 100	423	703 693 275	431	816 167 160	423	829 117 970	423	880 117 170	416		
626 693 700	423	703 693 300	430	816 167 450	423	829 127 100	424	880 127 170	415		
626 693 900	423	703 693 350	430	816 167 550	423	829 127 160	424	880 157 170	416		
627 167 100	425	703 693 375	431	816 167 600	423	829 127 210	424	880 167 170	415		
627 167 160	425	703 693 450	430	816 167 650	423	829 127 230	424	880 348 170	414		
627 348 160	425	703 693 475	431	816 167 700	423	829 127 900	424	880 693 170	414		
627 348 900	425	703 693 500	430	816 167 900	423	829 167 100	424	882 117 170	419		
627 693 100	425	703 693 575	431	816 167 970	423	829 167 160	424	882 127 170	418		
627 693 160	425	703 693 600	430	816 348 100	422	829 167 210	424	882 157 170	419		
627 693 900	425	703 693 675	431	816 348 160	422	829 167 230	424	882 167 170	418		
678 693 450	421	703 693 700	430	816 348 450	422	829 167 240	427	882 348 170	417		
678 693 550	421	703 693 775	431	816 348 550	422	829 167 900	424	882 693 170	417		
678 693 700	421	703 693 900	430	816 348 600	422	829 167 970	424	889 348 100	425		
678 693 900	421	703 693 970	430	816 348 650	422	829 348 100	424	889 348 160	425		
678 693 970	421	724 693 700	429	816 348 700	422	829 348 160	424	889 348 210	425		
700 014 450	429	724 693 900	429	816 348 900	422	829 348 190	424	889 348 900	425		
703 157 350	431	724 693 970	429	816 348 970	422	829 348 210	424	889 348 970	425		
703 157 900	431	805 567 100	412	816 495 970	422	829 348 230	424	889 693 100	426		
703 400 350	431	805 567 160	412	816 693 100	422	829 348 240	427	889 693 160	426		
703 400 500	431	805 567 230	412	816 693 160	422	829 348 260	427	889 693 210	426		
703 400 700	431	806 494 450	420	816 693 450	422	829 348 740	427	889 693 230	426		
703 400 900	431	806 494 550	420	816 693 550	422	829 348 760	427	889 693 900	426		
703 494 300	430	811 348 570	413	816 693 600	422	829 348 900	424	897 348 700	411		
703 494 350	430	811 567 770	413	816 693 700	422	829 348 970	424	897 348 900	411		
703 494 450	430	814 693 450	421	816 693 710	422	829 693 100	424	897 693 450	411		
703 494 500	430	814 693 550	421	816 693 900	422	829 693 160	424	897 693 700	411		
703 494 600	430	814 693 600	421	816 693 970	422	829 693 190	424				
703 494 700	430	814 693 700	421	817 494 550	420	829 693 210	424				
703 494 900	430	814 693 900	421	817 693 450	420	829 693 230	424				
703 495 300	430	816 117 100	423	817 693 550	420	829 693 240	428				
703 495 450	430	816 117 160	423	818 693 450	421	829 693 260	428				
703 495 500	430	816 117 450	423	818 693 550	421	829 693 740	428				
703 495 600	430	816 117 550	423	818 693 600	421	829 693 900	424				
703 496 175	431	816 117 600	423	818 693 650	421	829 693 970	424				
703 496 275	431	816 117 650	423	818 693 900	421	830 228 200	420				
703 496 350	430	816 117 700	423	819 495 900	421	830 228 300	420				